

Mastering the FreeRTOS™ Real Time Kernel

This is the 161204 copy which does not yet cover FreeRTOS V9.0.0, FreeRTOS V10.0.0, or low power tick-less operation. Check <http://www.FreeRTOS.org> regularly for additional documentation and updates to this book. See <http://www.FreeRTOS.org/FreeRTOS-V9.html> for information on FreeRTOS V9.x.x. See <https://www.freertos.org/FreeRTOS-V10.html> for information on FreeRTOS V10.x.x. Applications created using FreeRTOS V9.x.x onwards can allocate all kernel objects statically at compile time, removing the need to include a heap memory manager.

This text is being provided for free. **In return we ask that you use the business contact email link on <http://www.FreeRTOS.org/contact> to provide feedback, comments and corrections.** Thank you.

Mastering the FreeRTOS™ Real Time Kernel

A Hands-On Tutorial Guide

Richard Barry

Pre-release 161204 Edition.

All text, source code, and diagrams are the exclusive property of Real Time Engineers Ltd. unless otherwise noted inline.

© Real Time Engineers Ltd. 2016. All rights reserved.

<http://www.FreeRTOS.org>
<http://www.FreeRTOS.org/plus>
<http://www.FreeRTOS.org/labs>

FreeRTOS™, FreeRTOS.org™ and the FreeRTOS logo are trademarks of Real Time Engineers Ltd. OPENRTOS® and SAFERTOS® are trademarks of WITTENSTEIN Aerospace and Simulation Ltd. All other brands or product names are the property of their respective holders.

To Caroline, India and Max.

Contents

Contents	ix
List of Figures	xvi
List of Code Listings	xix
List of Tables	xxiii
List of Notation.....	xxvi
Preface	1
Multitasking in Small Embedded Systems	2
About FreeRTOS	2
Value Proposition.....	3
A Note About Terminology	3
Why Use a Real-time Kernel?	3
FreeRTOS Features	5
Licensing, and The FreeRTOS, OpenRTOS, and SafeRTOS Family	6
Included Source Files and Projects	7
Obtaining the Examples that Accompany this Book	7
Chapter 1 The FreeRTOS Distribution	9
1.1 Chapter Introduction and Scope.....	10
Scope	10
1.2 Understanding the FreeRTOS Distribution	11
Definition: FreeRTOS Port	11
Building FreeRTOS.....	11
FreeRTOSConfig.h	11
The Official FreeRTOS Distribution	12
The Top Directories in the FreeRTOS Distribution	12
FreeRTOS Source Files Common to All Ports	12
FreeRTOS Source Files Specific to a Port	14
Header Files	15
1.3 Demo Applications	16
1.4 Creating a FreeRTOS Project	18
Adapting One of the Supplied Demo Projects	18
Creating a New Project from Scratch	19
1.5 Data Types and Coding Style Guide	20
Data Types	21
Variable Names	22
Function Names.....	22
Formatting.....	23

Macro Names.....	23
Rationale for Excessive Type Casting	24
Chapter 2 Heap Memory Management.....	25
2.1 Chapter Introduction and Scope	26
Prerequisites	26
Dynamic Memory Allocation and its Relevance to FreeRTOS.....	26
Options for Dynamic Memory Allocation.....	27
Scope.....	28
2.2 Example Memory Allocation Schemes	29
From FreeRTOS V9.0.0 FreeRTOS applications can be completely statically allocated, removing the need to include a heap memory manager.....	29
Heap_1	29
Heap_2	30
Heap_3	32
Heap_4	32
Setting a Start Address for the Array Used By Heap_4	34
Heap_5	35
The vPortDefineHeapRegions() API Function	36
2.3 Heap Related Utility Functions	41
The xPortGetFreeHeapSize() API Function.....	41
The xPortGetMinimumEverFreeHeapSize() API Function	41
Malloc Failed Hook Functions	42
Chapter 3 Task Management	44
3.1 Chapter Introduction and Scope	45
Scope.....	45
3.2 Task Functions.....	46
3.3 Top Level Task States.....	47
3.4 Creating Tasks	48
The xTaskCreate() API Function	48
Example 1. Creating tasks	51
Example 2. Using the task parameter.....	55
3.5 Task Priorities	58
3.6 Time Measurement and the Tick Interrupt	60
Example 3. Experimenting with priorities	62
3.7 Expanding the 'Not Running' State	64
The Blocked State.....	64
The Suspended State.....	65
The Ready State	65
Completing the State Transition Diagram	65
Example 4. Using the Blocked state to create a delay	66
The vTaskDelayUntil() API Function.....	70
Example 5. Converting the example tasks to use vTaskDelayUntil()	71

Example 6. Combining blocking and non-blocking tasks	72
3.8 The Idle Task and the Idle Task Hook	75
Idle Task Hook Functions.....	75
Limitations on the Implementation of Idle Task Hook Functions	76
Example 7. Defining an idle task hook function	76
3.9 Changing the Priority of a Task	79
The vTaskPrioritySet() API Function	79
The uxTaskPriorityGet() API Function.....	79
Example 8. Changing task priorities	80
3.10 Deleting a Task	85
The vTaskDelete() API Function	85
Example 9. Deleting tasks.....	86
3.11 Thread Local Storage.....	89
3.12 Scheduling Algorithms	90
A Recap of Task States and Events.....	90
Configuring the Scheduling Algorithm	90
Prioritized Pre-emptive Scheduling with Time Slicing.....	91
Prioritized Pre-emptive Scheduling (without Time Slicing).....	95
Co-operative Scheduling.....	97
Chapter 4 Queue Management.....	101
4.1 Chapter Introduction and Scope.....	102
Scope	102
4.2 Characteristics of a Queue.....	103
Data Storage.....	103
Access by Multiple Tasks.....	106
Blocking on Queue Reads	106
Blocking on Queue Writes.....	106
Blocking on Multiple Queues.....	107
4.3 Using a Queue	108
The xQueueCreate() API Function.....	108
The xQueueSendToBack() and xQueueSendToFront() API Functions	109
The xQueueReceive() API Function.....	111
The uxQueueMessagesWaiting() API Function.....	113
Example 10. Blocking when receiving from a queue	114
4.4 Receiving Data From Multiple Sources	119
Example 11. Blocking when sending to a queue, and sending structures on a queue..	120
4.5 Working with Large or Variable Sized Data	126
Queuing Pointers	126
Using a Queue to Send Different Types and Lengths of Data	128
4.6 Receiving From Multiple Queues	131
Queue Sets.....	131
The xQueueCreateSet() API Function.....	132
The xQueueAddToSet() API Function.....	134

The xQueueSelectFromSet() API Function	135
Example 12. Using a Queue Set	137
More Realistic Queue Set Use Cases	141
4.7 Using a Queue to Create a Mailbox.....	143
The xQueueOverwrite() API Function.....	144
The xQueuePeek() API Function.....	145
Chapter 5 Software Timer Management.....	147
5.1 Chapter Introduction and Scope	148
Scope.....	148
5.2 Software Timer Callback Functions	149
5.3 Attributes and States of a Software Timer	150
Period of a Software Timer.....	150
One-shot and Auto-reload Timers	150
Software Timer States.....	151
5.4 The Context of a Software Timer	153
The RTOS Daemon (Timer Service) Task.....	153
The Timer Command Queue.....	153
Daemon Task Scheduling	154
5.5 Creating and Starting a Software Timer.....	158
The xTimerCreate() API Function.....	158
The xTimerStart() API Function.....	159
Example 13. Creating one-shot and auto-reload timers.....	163
5.6 The Timer ID	166
The vTimerSetTimerID() API Function	166
The pvTimerGetTimerID() API Function	166
Example 14. Using the callback function parameter and the software timer ID.....	167
5.7 Changing the Period of a Timer.....	170
The xTimerChangePeriod() API Function.....	170
5.8 Resetting a Software Timer	174
The xTimerReset() API Function	174
Example 15. Resetting a software timer	176
Chapter 6 Interrupt Management.....	181
6.1 Chapter Introduction and Scope	182
Events.....	182
Scope.....	183
6.2 Using the FreeRTOS API from an ISR	184
The Interrupt Safe API.....	184
The Benefits of Using a Separate Interrupt Safe API.....	184
The Disadvantages of Using a Separate Interrupt Safe API	185
The xHigherPriorityTaskWoken Parameter	185
The portYIELD_FROM_ISR() and portEND_SWITCHING_ISR() Macros.....	187
6.3 Deferred Interrupt Processing.....	189

6.4	Binary Semaphores Used for Synchronization	191
	The xSemaphoreCreateBinary() API Function	194
	The xSemaphoreTake() API Function	194
	The xSemaphoreGiveFromISR() API Function	196
	Example 16. Using a binary semaphore to synchronize a task with an interrupt	198
	Improving the Implementation of the Task Used in Example 16	202
6.5	Counting Semaphores	208
	The xSemaphoreCreateCounting() API Function	210
	Example 17. Using a counting semaphore to synchronize a task with an interrupt.....	211
6.6	Deferring Work to the RTOS Daemon Task	213
	The xTimerPendFunctionCallFromISR() API Function	214
	Example 18. Centralized deferred interrupt processing	216
6.7	Using Queues within an Interrupt Service Routine	220
	The xQueueSendToFrontFromISR() and xQueueSendToBackFromISR() API Functions	220
	Considerations When Using a Queue From an ISR	222
	Example 19. Sending and receiving on a queue from within an interrupt	222
6.8	Interrupt Nesting	228
	A Note to ARM Cortex-M and ARM GIC Users	230
Chapter 7	Resource Management	233
7.1	Chapter Introduction and Scope.....	234
	Mutual Exclusion.....	236
	Scope	237
7.2	Critical Sections and Suspending the Scheduler	238
	Basic Critical Sections	238
	Suspending (or Locking) the Scheduler	240
	The vTaskSuspendAll() API Function.....	241
	The xTaskResumeAll() API Function	241
7.3	Mutexes (and Binary Semaphores)	243
	The xSemaphoreCreateMutex() API Function.....	245
	Example 20. Rewriting vPrintString() to use a semaphore	245
	Priority Inversion	249
	Priority Inheritance	250
	Deadlock (or Deadly Embrace)	251
	Recursive Mutexes	252
	Mutexes and Task Scheduling	255
7.4	Gatekeeper Tasks.....	259
	Example 21. Re-writing vPrintString() to use a gatekeeper task.....	259
Chapter 8	Event Groups.....	265
8.1	Chapter Introduction and Scope.....	266
	Scope	266
8.2	Characteristics of an Event Group.....	268

Event Groups, Event Flags and Event Bits.....	268
More About the EventBits_t Data Type	269
Access by Multiple Tasks	269
A Practical Example of Using an Event Group	269
8.3 Event Management Using Event Groups.....	271
The xEventGroupCreate() API Function	271
The xEventGroupSetBits() API Function	271
The xEventGroupSetBitsFromISR() API Function	272
The xEventGroupWaitBits() API Function.....	275
Example 22. Experimenting with event groups.....	279
8.4 Task Synchronization Using an Event Group	285
The xEventGroupSync() API Function.....	287
Example 23. Synchronizing tasks.....	289
Chapter 9 Task Notifications.....	293
9.1 Chapter Introduction and Scope	294
Communicating Through Intermediary Objects.....	294
Task Notifications—Direct to Task Communication	294
Scope.....	295
9.2 Task Notifications; Benefits and Limitations.....	296
Performance Benefits of Task Notifications	296
RAM Footprint Benefits of Task Notifications	296
Limitations of Task Notifications	296
9.3 Using Task Notifications	298
Task Notification API Options.....	298
The xTaskNotifyGive() API Function	298
The vTaskNotifyGiveFromISR() API Function	299
The ulTaskNotifyTake() API Function.....	300
Example 24. Using a task notification in place of a semaphore, method 1.....	302
Example 25. Using a task notification in place of a semaphore, method 2.....	305
The xTaskNotify() and xTaskNotifyFromISR() API Functions	307
The xTaskNotifyWait() API Function.....	310
Task Notifications Used in Peripheral Device Drivers: UART Example.....	313
Task Notifications Used in Peripheral Device Drivers: ADC Example.....	320
Task Notifications Used Directly Within an Application	322
Chapter 10 Low Power Support.....	327
Chapter 11 Developer Support	328
11.1 Chapter Introduction and Scope	329
11.2 configASSERT()	330
Example configASSERT() definitions	330
11.3 FreeRTOS+Trace.....	332
11.4 Debug Related Hook (Callback) Functions.....	336

Malloc failed hook	336
11.5 Viewing Run-time and Task State Information.....	337
Task Run-Time Statistics	337
The Run-Time Statistics Clock	337
Configuring an Application to Collect Run-Time Statistics	338
The uxTaskGetSystemState() API Function.....	339
The vTaskList() Helper Function	342
The vTaskGetRunTimeStats() Helper Function.....	344
Generating and Displaying Run-Time Statistics, a Worked Example.....	345
11.6 Trace Hook Macros.....	348
Available Trace Hook Macros	348
Defining Trace Hook Macros.....	352
FreeRTOS Aware Debugger Plug-ins	353
Chapter 12 Trouble Shooting	355
12.1 Chapter Introduction and Scope.....	356
12.2 Interrupt Priorities.....	357
12.3 Stack Overflow.....	359
The uxTaskGetStackHighWaterMark() API Function	359
Run Time Stack Checking—Overview	360
Run Time Stack Checking—Method 1	360
Run Time Stack Checking—Method 2	361
12.4 Inappropriate Use of printf() and sprintf().....	362
Printf-stdarg.c	362
12.5 Other Common Sources of Error.....	364
Symptom: Adding a simple task to a demo causes the demo to crash	364
Symptom: Using an API function within an interrupt causes the application to crash ...	364
Symptom: Sometimes the application crashes within an interrupt service routine	364
Symptom: The scheduler crashes when attempting to start the first task	365
Symptom: Interrupts are unexpectedly left disabled, or critical sections do not nest correctly	365
Symptom: The application crashes even before the scheduler is started	365
Symptom: Calling API functions while the scheduler is suspended, or from inside a critical section, causes the application to crash.....	366
INDEX	368

List of Figures

Figure 1. Top level directories within the FreeRTOS distribution	12
Figure 2. Core FreeRTOS source files within the FreeRTOS directory tree.....	13
Figure 3. Port specific source files within the FreeRTOS directory tree	14
Figure 4. The demo directory hierarchy.....	17
Figure 5. RAM being allocated from the heap_1 array each time a task is created	30
Figure 6. RAM being allocated and freed from the heap_2 array as tasks are created and deleted.....	31
Figure 7. RAM being allocated and freed from the heap_4 array	33
Figure 8 Memory Map	37
Figure 9. Top level task states and transitions.....	47
Figure 10. The output produced when Example 1 is executed	53
Figure 11. The actual execution pattern of the two Example 1 tasks	54
Figure 12. The execution sequence expanded to show the tick interrupt executing	61
Figure 13. Running both tasks at different priorities	63
Figure 14. The execution pattern when one task has a higher priority than the other	63
Figure 15. Full task state machine.....	66
Figure 16. The output produced when Example 4 is executed	68
Figure 17. The execution sequence when the tasks use vTaskDelay() in place of the NULL loop.....	69
Figure 18. Bold lines indicate the state transitions performed by the tasks in Example 4	70
Figure 19. The output produced when Example 6 is executed	74
Figure 20. The execution pattern of Example 6.....	74
Figure 21. The output produced when Example 7 is executed	78
Figure 22. The sequence of task execution when running Example 8.....	83
Figure 23. The output produced when Example 8 is executed	84
Figure 24. The output produced when Example 9 is executed	87
Figure 25. The execution sequence for example 9.....	88
Figure 26. Execution pattern highlighting task prioritization and pre-emption in a hypothetical application in which each task has been assigned a unique priority.....	92
Figure 27 Execution pattern highlighting task prioritization and time slicing in a hypothetical application in which two tasks run at the same priority	94
Figure 28 The execution pattern for the same scenario as shown in Figure 27, but this time with configIDLE_SHOULD_YIELD set to 1	95
Figure 29 Execution pattern that demonstrates how tasks of equal priority can receive hugely different amounts of processing time when time slicing is not used	96
Figure 30 Execution pattern demonstrating the behavior of the co-operative scheduler	98
Figure 31. An example sequence of writes to, and reads from a queue	104
Figure 32. The output produced when Example 10 is executed	118
Figure 33. The sequence of execution produced by Example 10	118
Figure 34. An example scenario where structures are sent on a queue	119
Figure 35 The output produced by Example 11	123

Figure 36. The sequence of execution produced by Example 11	124
Figure 37 The output produced when Example 12 is executed.....	141
Figure 38 The difference in behavior between one-shot and auto-reload software timers.....	150
Figure 39 Auto-reload software timer states and transitions.....	152
Figure 40 One-shot software timer states and transitions	152
Figure 41 The timer command queue being used by a software timer API function to communicate with the RTOS daemon task.....	154
Figure 42 The execution pattern when the priority of a task calling xTimerStart() is above the priority of the daemon task.....	154
Figure 43 The execution pattern when the priority of a task calling xTimerStart() is below the priority of the daemon task.....	156
Figure 44 The output produced when Example 13 is executed.....	165
Figure 45 The output produced when Example 14 is executed.....	169
Figure 46 Starting and resetting a software timer that has a period of 6 ticks.....	174
Figure 47 The output produced when Example 15 is executed.....	179
Figure 48 Completing interrupt processing in a high priority task	190
Figure 49. Using a binary semaphore to implement deferred interrupt processing.....	191
Figure 50. Using a binary semaphore to synchronize a task with an interrupt.....	193
Figure 51. The output produced when Example 16 is executed.....	201
Figure 52. The sequence of execution when Example 16 is executed.....	202
Figure 53. The scenario when one interrupt occurs before the task has finished processing the first event.....	204
Figure 54 The scenario when two interrupts occur before the task has finished processing the first event.....	205
Figure 55. Using a counting semaphore to 'count' events	209
Figure 56. The output produced when Example 17 is executed.....	212
Figure 57. The output produced when Example 18 is executed.....	218
Figure 58 The sequence of execution when Example 18 is executed.....	219
Figure 59. The output produced when Example 19 is executed.....	226
Figure 60. The sequence of execution produced by Example 19.....	227
Figure 61. Constants affecting interrupt nesting behavior	230
Figure 62 How a priority of binary 101 is stored by a Cortex-M microcontroller that implements four priority bits.....	231
Figure 63. Mutual exclusion implemented using a mutex.....	244
Figure 64. The output produced when Example 20 is executed.....	248
Figure 65. A possible sequence of execution for Example 20.....	249
Figure 66. A worst case priority inversion scenario	250
Figure 67. Priority inheritance minimizing the effect of priority inversion	251
Figure 68 A possible sequence of execution when tasks that have the same priority use the same mutex.....	255
Figure 69 A sequence of execution that could occur if two instances of the task shown by Listing 125 are created at the same priority	257
Figure 70. The output produced when Example 21 is executed.....	264
Figure 71 Event flag to bit number mapping in a variable of type EventBits_t	268

Figure 72 An event group in which only bits 1, 4 and 7 are set, and all the other event flags are clear, making the event group's value 0x92.....	268
Figure 73 The output produced when Example 22 is executed with xWaitForAllBits set to pdFALSE	283
Figure 74 The output produced when Example 22 is executed with xWaitForAllBits set to pdTRUE.....	284
Figure 75 The output produced when Example 23 is executed	292
Figure 76 A communication object being used to send an event from one task to another....	294
Figure 77 A task notification used to send an event directly from one task to another	295
Figure 78. The output produced when Example 16 is executed	304
Figure 79. The sequence of execution when Example 24 is executed	305
Figure 80. The output produced when Example 25 is executed	307
Figure 81 The communication paths from the application tasks to the cloud server, and back again	323
Figure 82 FreeRTOS+Trace includes more than 20 interconnected views	332
Figure 83 FreeRTOS+Trace main trace view - one of more than 20 interconnected trace views	333
Figure 84 FreeRTOS+Trace CPU load view - one of more than 20 interconnected trace views	334
Figure 85 FreeRTOS+Trace response time view - one of more than 20 interconnected trace views.....	334
Figure 86 FreeRTOS+Trace user event plot view - one of more than 20 interconnected trace views.....	335
Figure 87 FreeRTOS+Trace kernel object history view - one of more than 20 interconnected trace views.....	335
Figure 88 Example output generated by vTaskList()	344
Figure 89 Example output generated by vTaskGetRunTimeStats().....	345
Figure 90 FreeRTOS ThreadSpy Eclipse plug-in from Code Confidence Ltd.	353

List of Code Listings

Listing 1. The template for a new main() function.....	18
Listing 2. Using GCC syntax to declare the array that will be used by heap_4, and place the array in a memory section named .my_heap	35
Listing 3. Using IAR syntax to declare the array that will be used by heap_4, and place the array at the absolute address 0x20000000	35
Listing 4. The vPortDefineHeapRegions() API function prototype	36
Listing 5. The HeapRegion_t structure.....	36
Listing 6. An array of HeapRegion_t structures that together describe the 3 regions of RAM in their entirety	38
Listing 7. An array of HeapRegion_t structures that describe all of RAM2, all of RAM3, but only part of RAM1	39
Listing 8. The xPortGetFreeHeapSize() API function prototype.....	41
Listing 9. The xPortGetMinimumEverFreeHeapSize() API function prototype	41
Listing 10. The malloc failed hook function name and prototype.	42
Listing 11. The task function prototype.....	46
Listing 12. The structure of a typical task function.....	46
Listing 13. The xTaskCreate() API function prototype	48
Listing 14. Implementation of the first task used in Example 1	52
Listing 15. Implementation of the second task used in Example 1	52
Listing 16. Starting the Example 1 tasks	53
Listing 17. Creating a task from within another task after the scheduler has started	55
Listing 18. The single task function used to create two tasks in Example 2.....	56
Listing 19. The main() function for Example 2.	57
Listing 20. Using the pdMS_TO_TICKS() macro to convert 200 milliseconds into an equivalent time in tick periods.....	61
Listing 21. Creating two tasks at different priorities	62
Listing 22. The vTaskDelay() API function prototype.....	67
Listing 23. The source code for the example task after the null loop delay has been replaced by a call to vTaskDelay()	68
Listing 24. vTaskDelayUntil() API function prototype.....	71
Listing 25. The implementation of the example task using vTaskDelayUntil()	72
Listing 26. The continuous processing task used in Example 6.....	73
Listing 27. The periodic task used in Example 6	73
Listing 28. The idle task hook function name and prototype	76
Listing 29. A very simple Idle hook function	77
Listing 30. The source code for the example task now prints out the ullIdleCycleCount value.....	77
Listing 31. The vTaskPrioritySet() API function prototype	79
Listing 32. The uxTaskPriorityGet() API function prototype	79
Listing 33. The implementation of Task 1 in Example 8	81
Listing 34. The implementation of Task 2 in Example 8	82
Listing 35. The implementation of main() for Example 8.....	83

Listing 36. The vTaskDelete() API function prototype.....	85
Listing 37. The implementation of main() for Example 9.....	86
Listing 38. The implementation of Task 1 for Example 9.....	87
Listing 39. The implementation of Task 2 for Example 9.....	87
Listing 40. The xQueueCreate() API function prototype.....	108
Listing 41. The xQueueSendToFront() API function prototype.....	109
Listing 42. The xQueueSendToBack() API function prototype.....	109
Listing 43. The xQueueReceive() API function prototype.....	112
Listing 44. The uxQueueMessagesWaiting() API function prototype.....	113
Listing 45. Implementation of the sending task used in Example 10.....	115
Listing 46. Implementation of the receiver task for Example 10.....	116
Listing 47. The implementation of main() in Example 10.....	117
Listing 48. The definition of the structure that is to be passed on a queue, plus the declaration of two variables for use by the example.....	120
Listing 49. The implementation of the sending task for Example 11.....	121
Listing 50. The definition of the receiving task for Example 11.....	122
Listing 51. The implementation of main() for Example 11.....	123
Listing 52. Creating a queue that holds pointers.....	127
Listing 53. Using a queue to send a pointer to a buffer.....	127
Listing 54. Using a queue to receive a pointer to a buffer.....	127
Listing 55. The structure used to send events to the TCP/IP stack task in FreeRTOS+TCP.....	128
Listing 56. Pseudo code showing how an IPStackEvent_t structure is used to send data received from the network to the TCP/IP task.....	129
Listing 57. Pseudo code showing how an IPStackEvent_t structure is used to send the handle of a socket that is accepting a connection to the TCP/IP task.....	129
Listing 58. Pseudo code showing how an IPStackEvent_t structure is used to send a network down event to the TCP/IP task.....	130
Listing 59. Pseudo code showing how an IPStackEvent_t structure is used to send a network down to the TCP/IP task.....	130
Listing 60. The xQueueCreateSet() API function prototype.....	132
Listing 61. The xQueueAddToSet() API function prototype.....	134
Listing 62. The xQueueSelectFromSet() API function prototype.....	135
Listing 63. Implementation of main() for Example 12.....	138
Listing 64. The sending tasks used in Example 12.....	139
Listing 65. The receive task used in Example 12.....	140
Listing 66. Using a queue set that contains queues and semaphores.....	142
Listing 67. A queue being created for use as a mailbox.....	144
Listing 68. The xQueueOverwrite() API function prototype.....	144
Listing 69. Using the xQueueOverwrite() API function.....	145
Listing 70. The xQueuePeek() API function prototype.....	146
Listing 71. Using the xQueuePeek() API function.....	146
Listing 72. The software timer callback function prototype.....	149
Listing 73. The xTimerCreate() API function prototype.....	158

Listing 74. The xTimerStart() API function prototype.....	160
Listing 75. Creating and starting the timers used in Example 13.....	163
Listing 76. The callback function used by the one-shot timer in Example 13.....	164
Listing 77. The callback function used by the auto-reload timer in Example 13.....	164
Listing 78. The vTimerSetTimerID() API function prototype	166
Listing 79. The pvTimerGetTimerID() API function prototype	166
Listing 80. Creating the timers used in Example 14	167
Listing 81. The timer callback function used in Example 14	168
Listing 82. The xTimerChangePeriod() API function prototype.....	170
Listing 83. Using xTimerChangePeriod()	173
Listing 84. The xTimerReset() API function prototype	175
Listing 85. The callback function for the one-shot timer used in Example 15.....	177
Listing 86. The task used to reset the software timer in Example 15.....	178
Listing 87. The portEND_SWITCHING_ISR() macros.....	188
Listing 88. The portYIELD_FROM_ISR() macros.....	188
Listing 89. The xSemaphoreCreateBinary() API function prototype	194
Listing 90. The xSemaphoreTake() API function prototype	195
Listing 91. The xSemaphoreGiveFromISR() API function prototype.....	196
Listing 92. Implementation of the task that periodically generates a software interrupt in Example 16	198
Listing 93. The implementation of the task to which the interrupt processing is deferred (the task that synchronizes with the interrupt) in Example 16.....	199
Listing 94. The ISR for the software interrupt used in Example 16.....	200
Listing 95. The implementation of main() for Example 16.....	201
Listing 96. The recommended structure of a deferred interrupt processing task, using a UART receive handler as an example	207
Listing 97. The xSemaphoreCreateCounting() API function prototype	210
Listing 98. The call to xSemaphoreCreateCounting() used to create the counting semaphore in Example 17	211
Listing 99. The implementation of the interrupt service routine used by Example 17.....	212
Listing 100. The xTimerPendFunctionCallFromISR() API function prototype	214
Listing 101. The prototype to which a function passed in the xFunctionToPend parameter of xTimerPendFunctionCallFromISR() must conform.....	214
Listing 102. The software interrupt handler used in Example 18	217
Listing 103. The function that performs the processing necessitated by the interrupt in Example 18.	217
Listing 104. The implementation of main() for Example 18.....	218
Listing 105. The xQueueSendToFrontFromISR() API function prototype	220
Listing 106. The xQueueSendToBackFromISR() API function prototype	220
Listing 107. The implementation of the task that writes to the queue in Example 19.....	223
Listing 108. The implementation of the interrupt service routine used by Example 19.....	224
Listing 109. The task that prints out the strings received from the interrupt service routine in Example 19.....	225
Listing 110. The main() function for Example 19	226
Listing 111. An example read, modify, write sequence	234

Listing 112. An example of a reentrant function.....	236
Listing 113. An example of a function that is not reentrant	236
Listing 114. Using a critical section to guard access to a register	238
Listing 115. A possible implementation of vPrintString().....	239
Listing 116. Using a critical section in an interrupt service routine	240
Listing 117. The vTaskSuspendAll() API function prototype	241
Listing 118. The xTaskResumeAll() API function prototype	241
Listing 119. The implementation of vPrintString()	242
Listing 120. The xSemaphoreCreateMutex() API function prototype	245
Listing 121. The implementation of prvNewPrintString().....	246
Listing 122. The implementation of prvPrintTask() for Example 20.....	247
Listing 123. The implementation of main() for Example 20	248
Listing 124. Creating and using a recursive mutex	254
Listing 125. A task that uses a mutex in a tight loop	256
Listing 126. Ensuring tasks that use a mutex in a loop receive a more equal amount of processing time, while also ensuring processing time is not wasted by switching between tasks too rapidly	258
Listing 127. The name and prototype for a tick hook function.....	260
Listing 128. The gatekeeper task	260
Listing 129. The print task implementation for Example 21	261
Listing 130. The tick hook implementation.....	262
Listing 131. The implementation of main() for Example 21	263
Listing 132. The xEventGroupCreate() API function prototype	271
Listing 133. The xEventGroupSetBits() API function prototype.....	272
Listing 134. The xEventGroupSetBitsFromISR() API function prototype.....	273
Listing 135. The xEventGroupWaitBits() API function prototype.....	275
Listing 136. Event bit definitions used in Example 22	279
Listing 137. The task that sets two bits in the event group in Example 22	280
Listing 138. The ISR that sets bit 2 in the event group in Example 22	281
Listing 139. The task that blocks to wait for event bits to become set in Example 22	282
Listing 140. Creating the event group and tasks in Example 22	283
Listing 141. Pseudo code for two tasks that synchronize with each other to ensure a shared TCP socket is no longer in use by either task before the socket is closed	286
Listing 142. The xEventGroupSync() API function prototype	288
Listing 143. The implementation of the task used in Example 23	290
Listing 144. The main() function used in Example 23	291
Listing 145. The xTaskNotifyGive() API function prototype.....	298
Listing 146. The vTaskNotifyGiveFromISR() API function prototype.....	299
Listing 147. The ulTaskNotifyTake() API function prototype	300
Listing 148. The implementation of the task to which the interrupt processing is deferred (the task that synchronizes with the interrupt) in Example 24.....	303
Listing 149. The implementation of the interrupt service routine used in Example 24.....	304

Listing 150. The implementation of the task to which the interrupt processing is deferred (the task that synchronizes with the interrupt) in Example 25.....	306
Listing 151. The implementation of the interrupt service routine used in Example 25.....	306
Listing 152. Prototypes for the xTaskNotify() and xTaskNotifyFromISR() API functions	308
Listing 153. The xTaskNotifyWait() API function prototype.....	310
Listing 154. Pseudo code demonstrating how a binary semaphore can be used in a driver library transmit function.....	315
Listing 155. Pseudo code demonstrating how a task notification can be used in a driver library transmit function.....	317
Listing 156. Pseudo code demonstrating how a task notification can be used in a driver library receive function.....	319
Listing 157. Pseudo code demonstrating how a task notification can be used to pass a value to a task	321
Listing 158. The structure and data type sent on a queue to the server task.....	323
Listing 159. The Implementation of the Cloud Read API Function	324
Listing 160. The Server Task Processing a Read Request	324
Listing 161. The Implementation of the Cloud Write API Function.....	325
Listing 162. The Server Task Processing a Send Request	326
Listing 163 Using the standard C assert() macro to check pxMyPointer is not NULL	330
Listing 164 A simple configASSERT() definition useful when executing under the control of a debugger	331
Listing 165 A configASSERT() definition that records the source code line that failed an assertion.....	331
Listing 166. The uxTaskGetSystemState() API function prototype	339
Listing 167. The TaskStatus_t structure.....	341
Listing 168. The vTaskList() API function prototype	343
Listing 169. The vTaskGetRunTimeStats() API function prototype.....	344
Listing 170. 16-bit timer overflow interrupt handler used to count timer overflows	346
Listing 171. Macros added to FreeRTOSConfig.h to enable the collection of run-time statistics.....	346
Listing 172. The task that prints out the collected run-time statistics	347
Listing 173. The uxTaskGetStackHighWaterMark() API function prototype.....	359
Listing 174. The stack overflow hook function prototype	360

List of Tables

Table 1. FreeRTOS source files to include in the project	20
Table 2. Port specific data types used by FreeRTOS.....	21
Table 3. Macro prefixes	23
Table 4. Common macro definitions.....	23
Table 5. vPortDefineHeapRegions() parameters.....	37
Table 6. xPortGetFreeHeapSize() return value	41
Table 7. xPortGetMinimumEverFreeHeapSize() return value.....	42
Table 8. xTaskCreate() parameters and return value	48
Table 9. vTaskDelay() parameters.....	67

Table 10.	vTaskDelayUntil() parameters	71
Table 11.	vTaskPrioritySet() parameters	79
Table 12.	uxTaskPriorityGet() parameters and return value	80
Table 13.	vTaskDelete() parameters	85
Table 14.	The FreeRTOSConfig.h settings that configure the kernel to use Prioritized Pre-emptive Scheduling with Time Slicing	91
Table 15.	An explanation of the terms used to describe the scheduling policy	92
Table 16.	The FreeRTOSConfig.h settings that configure the kernel to use Prioritized Pre-emptive Scheduling without Time Slicing.....	96
Table 17.	The FreeRTOSConfig.h settings that configure the kernel to use co-operative scheduling	98
Table 18.	xQueueCreate() parameters and return value	108
Table 19.	xQueueSendToFront() and xQueueSendToBack() function parameters and return value.....	109
Table 20.	xQueueReceive() function parameters and return values	112
Table 21.	uxQueueMessagesWaiting() function parameters and return value.....	114
Table 22.	Key to Figure 36.....	124
Table 23.	xQueueCreateSet() parameters and return value	133
Table 24.	xQueueAddToSet() parameters and return value	134
Table 25.	xQueueSelectFromSet() parameters and return value	136
Table 26.	xQueueOverwrite() parameters and return value.....	145
Table 27.	xTimerCreate() parameters and return value.....	158
Table 28.	xTimerStart() parameters and return value	160
Table 29.	vTimerSetTimerID() parameters	166
Table 30.	pvTimerGetTimerID() parameters and return value	167
Table 31.	xTimerChangePeriod() parameters and return value.....	171
Table 32.	xTimerReset() parameters and return value	175
Table 33.	xSemaphoreCreateBinary() Return Value	194
Table 34.	xSemaphoreTake() parameters and return value	195
Table 35.	xSemaphoreGiveFromISR() parameters and return value.....	197
Table 36.	xSemaphoreCreateCounting() parameters and return value	210
Table 37.	xTimerPendFunctionCallFromISR() parameters and return value	214
Table 38.	xQueueSendToFrontFromISR() and xQueueSendToBackFromISR() parameters and return values	220
Table 39.	Constants that control interrupt nesting	228
Table 40.	xTaskResumeAll() return value	241
Table 41.	xSemaphoreCreateMutex() return value.....	245
Table 42.	xEventGroupCreate() return value.....	271
Table 43.	xEventGroupSetBits() parameters and return value	272
Table 44.	xEventGroupSetBitsFromISR() parameters and return value	273
Table 45.	The Effect of the uxBitsToWaitFor and xWaitForAllBits Parameters	275
Table 46.	xEventGroupWaitBits() parameters and return value.....	277
Table 47.	xEventGroupSync() parameters and return value.....	288
Table 48.	xTaskNotifyGive() parameters and return value	299

Table 49. vTaskNotifyGiveFromISR() parameters and return value	299
Table 50. ulTaskNotifyTake() parameters and return value.....	301
Table 51. xTaskNotify() parameters and return value	308
Table 52. Valid xTaskNotify() eNotifyAction Parameter Values, and Their Resultant Effect on the Receiving Task's Notification Value	309
Table 53. xTaskNotifyWait() parameters and return value	310
Table 54. Macros used in the collection of run-time statistics.....	338
Table 55. uxTaskGetSystemState() parameters and return value	340
Table 56. TaskStatus_t structure members.....	341
Table 57. vTaskList() parameters	343
Table 58. vTaskGetRunTimeStats() parameters	344
Table 59. A selection of the most commonly used trace hook macros	348
Table 60. uxTaskGetStackHighWaterMark() parameters and return value.....	359

List of Notation

ADC	Analog to Digital Converter
API	Application Programming Interface
DMA	Direct Memory Access
FAQ	Frequently Asked Question
FIFO	First In First Out
HMI	Human Machine Interface
IDE	Integrated Development Environment
IRQ	Interrupt Request
ISR	Interrupt Service Routine
LCD	Liquid Crystal Display
MCU	Microcontroller
RMS	Rate Monotonic Scheduling
RTOS	Real-time Operating System
SIL	Safety Integrity Level
SPI	Serial Peripheral Interface
TCB	Task Control Block
UART	Universal Asynchronous Receiver/Transmitter

Preface

Multitasking in Small Embedded Systems

About FreeRTOS

FreeRTOS is solely owned, developed and maintained by Real Time Engineers Ltd. Real Time Engineers Ltd. have been working in close partnership with the world's leading chip companies for well over a decade to provide you award winning, commercial grade, and completely free high quality software.

FreeRTOS is ideally suited to deeply embedded real-time applications that use microcontrollers or small microprocessors. This type of application normally includes a mix of both hard and soft real-time requirements.

Soft real-time requirements are those that state a time deadline—but breaching the deadline would not render the system useless. For example, responding to keystrokes too slowly might make a system seem annoyingly unresponsive without actually making it unusable.

Hard real-time requirements are those that state a time deadline—and breaching the deadline would result in absolute failure of the system. For example, a driver's airbag has the potential to do more harm than good if it responded to crash sensor inputs too slowly.

FreeRTOS is a real-time kernel (or real-time scheduler) on top of which embedded applications can be built to meet their hard real-time requirements. It allows applications to be organized as a collection of independent threads of execution. On a processor that has only one core, only a single thread can be executing at any one time. The kernel decides which thread should be executing by examining the priority assigned to each thread by the application designer. In the simplest case, the application designer could assign higher priorities to threads that implement hard real-time requirements, and lower priorities to threads that implement soft real-time requirements. This would ensure that hard real-time threads are always executed ahead of soft real-time threads, but priority assignment decisions are not always that simplistic.

Do not be concerned if you do not fully understand the concepts in the previous paragraph yet. The following chapters provide a detailed explanation, with many examples, to help you understand how to use a real-time kernel, and how to use FreeRTOS, in particular.

Value Proposition

The unprecedented global success of FreeRTOS comes from its compelling value proposition; FreeRTOS is professionally developed, strictly quality controlled, robust, supported, does not contain any intellectual property ownership ambiguity, and is truly free to use in commercial applications without any requirement to expose your proprietary source code. You can take a product to market using FreeRTOS without even talking to Real Time Engineers Ltd., let alone paying any fees, and thousands of people do just that. If, at any time, you would like to receive additional backup, or if your legal team require additional written guarantees or indemnification, then there is a simple low cost commercial upgrade path. Peace of mind comes with the knowledge that you can opt to take the commercial route at any time you choose.

A Note About Terminology

In FreeRTOS, each thread of execution is called a 'task'. There is no consensus on terminology within the embedded community, but I prefer 'task' to 'thread,' as thread can have a more specific meaning in some fields of application.

Why Use a Real-time Kernel?

There are many well established techniques for writing good embedded software without the use of a kernel, and, if the system being developed is simple, then these techniques might provide the most appropriate solution. In more complex cases, it is likely that using a kernel would be preferable, but where the crossover point occurs will always be subjective.

As already described, task prioritization can help ensure an application meets its processing deadlines, but a kernel can bring other less obvious benefits, too. Some of these are listed very briefly below.

- Abstracting away timing information

The kernel is responsible for execution timing and provides a time-related API to the application. This allows the structure of the application code to be simpler, and the overall code size to be smaller.

- Maintainability/Extensibility

Abstracting away timing details results in fewer interdependencies between modules, and allows the software to evolve in a controlled and predictable way. Also, the kernel is responsible for timing, so application performance is less susceptible to changes in the underlying hardware.

- Modularity

Tasks are independent modules, each of which should have a well-defined purpose.

- Team development

Tasks should also have well-defined interfaces, allowing easier development by teams.

- Easier testing

If tasks are well-defined independent modules with clean interfaces, they can be tested in isolation.

- Code reuse

Greater modularity and fewer interdependencies results in code that can be reused with less effort.

- Improved efficiency

Using a kernel allows software to be completely event-driven, so no processing time is wasted by polling for events that have not occurred. Code executes only when there is something that must be done.

Counter to the efficiency saving is the need to process the RTOS tick interrupt, and to switch execution from one task to another. However, applications that don't make use of an RTOS normally include some form of tick interrupt anyway.

- Idle time

The Idle task is created automatically when the scheduler is started. It executes whenever there are no application tasks wishing to execute. The idle task can be used to measure spare processing capacity, to perform background checks, or simply to place the processor into a low-power mode.

- Power Management

The efficiency gains that are obtained by using an RTOS allow the processor to spend more time in a low power mode.

Power consumption can be decreased significantly by placing the processor into a low power state each time the Idle task runs. FreeRTOS also has a special tick-less mode. Using the tick-less mode allows the processor to enter a lower power mode than would otherwise be possible, and remain in the low power mode for longer.

- Flexible interrupt handling

Interrupt handlers can be kept very short by deferring processing to either a task created by the application writer, or the FreeRTOS daemon task.

- Mixed processing requirements

Simple design patterns can achieve a mix of periodic, continuous and event-driven processing within an application. In addition, hard and soft real-time requirements can be met by selecting appropriate task and interrupt priorities.

FreeRTOS Features

FreeRTOS has the following standard features:

- Pre-emptive or co-operative operation
- Very flexible task priority assignment
- Flexible, fast and light weight task notification mechanism
- Queues
- Binary semaphores
- Counting semaphores
- Mutexes
- Recursive Mutexes
- Software timers
- Event groups
- Tick hook functions
- Idle hook functions
- Stack overflow checking
- Trace recording
- Task run-time statistics gathering

- Optional commercial licensing and support
- Full interrupt nesting model (for some architectures)
- A tick-less capability for extreme low power applications
- Software managed interrupt stack when appropriate (this can help save RAM)

Licensing, and The FreeRTOS, OpenRTOS, and SafeRTOS Family

The **FreeRTOS** open source license is designed to ensure:

1. FreeRTOS can be used in commercial applications.
2. FreeRTOS itself remains freely available to everybody.
3. FreeRTOS users retain ownership of their intellectual property.

See <http://www.FreeRTOS.org/license> for the latest open source license information.

OpenRTOS is a commercially licensed version of FreeRTOS provided under license from Real Time Engineers Ltd. by a third party.

SafeRTOS shares the same usage model as FreeRTOS, but has been developed in accordance with the practices, procedures, and processes necessary to claim compliance with various internationally recognized safety related standards.

Included Source Files and Projects

Obtaining the Examples that Accompany this Book

Source code, pre-configured project files, and full build instructions for all the examples presented in this book are provided in an accompanying zip file. You can download the zip file from <http://www.FreeRTOS.org/Documentation/code> if you did not receive a copy with the book. **The zip file may not include the latest version of FreeRTOS.**

The screen shots included in this book were taken while the examples were executing in a Microsoft Windows environment, using the FreeRTOS Windows port. The project that uses the FreeRTOS Windows port is pre-configured to build using the free Express edition of Visual Studio, which can be downloaded from <http://www.microsoft.com/express>. Note that, while the FreeRTOS Windows port provides a convenient evaluation, test and development platform, it does *not* provide true real-time behavior.

Chapter 1

The FreeRTOS Distribution

1.1 Chapter Introduction and Scope

FreeRTOS is distributed as a single zip file archive that contains all the official FreeRTOS ports, and a large number of pre-configured demo applications.

Scope

This chapter aims to help users orientate themselves with the FreeRTOS files and directories by:

- Providing a top level view of the FreeRTOS directory structure.
- Describing which files are actually required by any particular FreeRTOS project.
- Introducing the demo applications.
- Providing information on how a new project can be created.

The description here relates only to the official FreeRTOS distribution. The examples that come with this book use a slightly different organization.

1.2 Understanding the FreeRTOS Distribution

Definition: FreeRTOS Port

FreeRTOS can be built with approximately twenty different compilers, and can run on more than thirty different processor architectures. Each supported combination of compiler and processor is considered to be a separate FreeRTOS port.

Building FreeRTOS

FreeRTOS can be thought of as a library that provides multi-tasking capabilities to what would otherwise be a bare metal application.

FreeRTOS is supplied as a set of C source files. Some of the source files are common to all ports, while others are specific to a port. Build the source files as part of your project to make the FreeRTOS API available to your application. To make this easy for you, each official FreeRTOS port is provided with a demo application. The demo application is pre-configured to build the correct source files, and include the correct header files.

Demo applications should build 'out of the box', although some demos are older than others, and sometimes a change in the build tools made since the demo was released can cause an issue. Section 1.3 describes the demo applications.

FreeRTOSConfig.h

FreeRTOS is configured by a header file called FreeRTOSConfig.h.

FreeRTOSConfig.h is used to tailor FreeRTOS for use in a specific application. For example, FreeRTOSConfig.h contains constants such as configUSE_PREEMPTION, the setting of which defines whether the co-operative or pre-emptive scheduling algorithm will be used¹. As FreeRTOSConfig.h contains application specific definitions, it should be located in a directory that is part of the application being built, not in a directory that contains the FreeRTOS source code.

A demo application is provided for every FreeRTOS port, and every demo application contains a FreeRTOSConfig.h file. It is therefore never necessary to create a FreeRTOSConfig.h file

¹ Scheduling algorithms are described in section 3.12.

from scratch. Instead, it is recommended to start with, then adapt, the FreeRTOSConfig.h used by the demo application provided for the FreeRTOS port in use.

The Official FreeRTOS Distribution

FreeRTOS is distributed in a single zip file. The zip file contains source code for all the FreeRTOS ports, and project files for all the FreeRTOS demo applications. It also contains a selection of FreeRTOS+ ecosystem components, and a selection of FreeRTOS+ ecosystem demo applications.

Do not be put off by the number of files in the FreeRTOS distribution! Only a very small number of files are required in any one application.

The Top Directories in the FreeRTOS Distribution

The first and second level directories of the FreeRTOS distribution are shown and described in Figure 1.

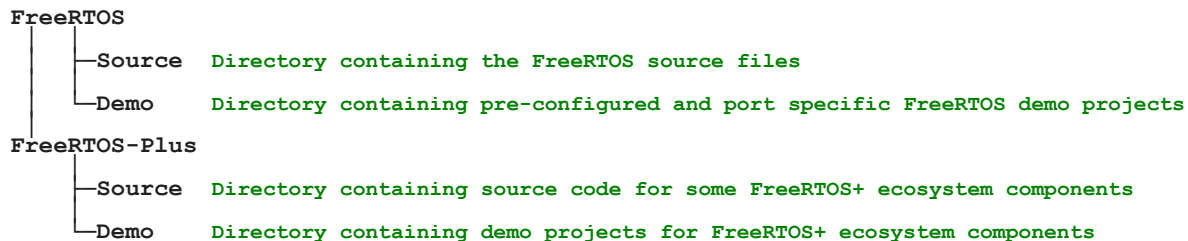

Figure 1. Top level directories within the FreeRTOS distribution

The zip file only contains one copy of the FreeRTOS source files; all the FreeRTOS demo projects, and all the FreeRTOS+ demo projects, expect to find the FreeRTOS source files in the FreeRTOS/Source directory, and may not build if the directory structure is changed.

FreeRTOS Source Files Common to All Ports

The core FreeRTOS source code is contained in just two C files that are common to all the FreeRTOS ports. These are called tasks.c, and list.c, and they are located directly in the FreeRTOS/Source directory, as shown in Figure 2. In addition to these two files, the following source files are located in the same directory:

- queue.c

queue.c provides both queue and semaphore services, as described later in this book. queue.c is nearly always required.

- timers.c

timers.c provides software timer functionality, as described later in this book. It need only be included in the build if software timers are actually going to be used.

- event_groups.c

event_groups.c provides event group functionality, as described later in this book. It need only be included in the build if event groups are actually going to be used.

- croutine.c

croutine.c implements the FreeRTOS co-routine functionality. It need only be included in the build if co-routines are actually going to be used. Co-routines were intended for use on very small microcontrollers, are rarely used now, and are therefore not maintained to the same level as other FreeRTOS features. Co-routines are not described in this book.

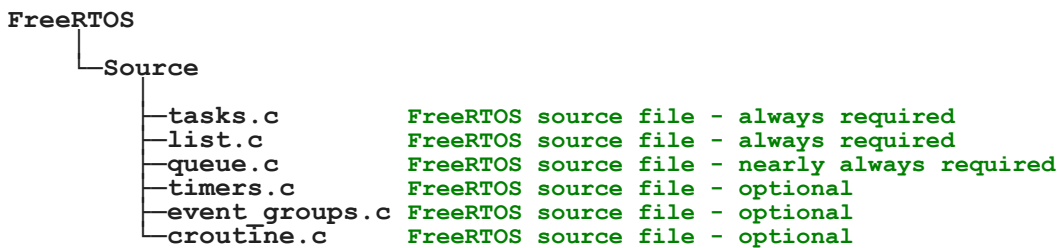

Figure 2. Core FreeRTOS source files within the FreeRTOS directory tree

It is recognized that the file names may result in name space clashes, as many projects will already include files that have the same names. It is however considered that changing the names of the files now would be problematic, as to do so would break compatibility with the many thousands of projects that use FreeRTOS, as well as automation tools, and IDE plug-ins.

FreeRTOS Source Files Specific to a Port

Source files specific to a FreeRTOS port are contained within the FreeRTOS/Source/portable directory. The portable directory is arranged as a hierarchy, first by compiler, then by processor architecture. The hierarchy is shown in Figure 3.

If you are running FreeRTOS on a processor with architecture '*architecture*' using compiler '*compiler*' then, in addition to the core FreeRTOS source files, you must also build the files located in FreeRTOS/Source/portable/[*compiler*]/[*architecture*] directory.

As will be described in Chapter 2, Heap Memory Management, FreeRTOS also considers heap memory allocation to be part of the portable layer. Projects that use a FreeRTOS version older than V9.0.0 must include a heap memory manager. From FreeRTOS V9.0.0 a heap memory manager is only required if configSUPPORT_DYNAMIC_ALLOCATION is set to 1 in FreeRTOSConfig.h, or if configSUPPORT_DYNAMIC_ALLOCATION is left undefined.

FreeRTOS provides five example heap allocation schemes. The five schemes are named heap_1 to heap_5, and are implemented by the source files heap_1.c to heap_5.c respectively. The example heap allocation schemes are contained in the FreeRTOS/Source/portable/MemMang directory. If you have configured FreeRTOS to use dynamic memory allocation then it is necessary to build *one* of these five source files in your project, unless your application provides an alternative implementation.

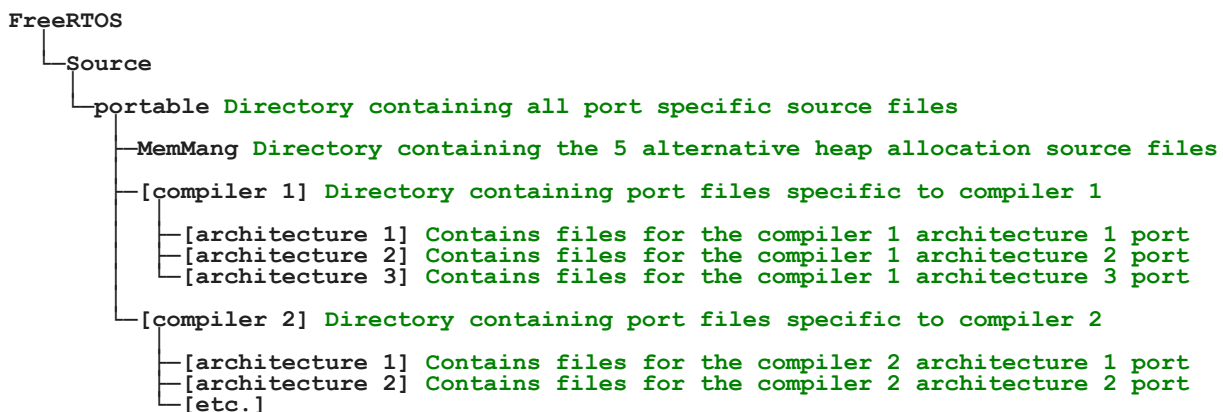

Figure 3. Port specific source files within the FreeRTOS directory tree

Include Paths

FreeRTOS requires three directories to be included in the compiler's include path. These are:

1. The path to the core FreeRTOS header files, which is always FreeRTOS/Source/include.
2. The path to the source files that are specific to the FreeRTOS port in use. As described above, this is FreeRTOS/Source/portable/[*compiler*]/[*architecture*].
3. A path to the FreeRTOSConfig.h header file.

Header Files

A source file that uses the FreeRTOS API must include 'FreeRTOS.h', followed by the header file that contains the prototype for the API function being used—either 'task.h', 'queue.h', 'semphr.h', 'timers.h' or 'event_groups.h'.

1.3 Demo Applications

Each FreeRTOS port comes with at least one demo application that should build with no errors or warnings being generated, although some demos are older than others, and sometimes a change in the build tools made since the demo was released can cause an issue.

A note to Linux users: FreeRTOS is developed and tested on a Windows host. Occasionally this results in build errors when demo projects are built on a Linux host. Build errors are almost always related to the case of letters used when referencing file names, or the direction of slash characters used in file paths. Please use the FreeRTOS contact form (<http://www.FreeRTOS.org/contact>) to alert us to any such errors.

The demo application has several purposes:

- To provide an example of a working and pre-configured project, with the correct files included, and the correct compiler options set.
- To allow 'out of the box' experimentation with minimal setup or prior knowledge.
- As a demonstration of how the FreeRTOS API can be used.
- As a base from which real applications can be created.

Each demo project is located in a unique sub-directory under the FreeRTOS/Demo directory. The name of the sub-directory indicates the port to which the demo project relates.

Every demo application is also described by a web page on the FreeRTOS.org web site. The web page includes information on:

- How to locate the project file for the demo within the FreeRTOS directory structure.
- Which hardware the project is configured to use.
- How to set up the hardware for running the demo.
- How to build the demo.
- How the demo is expected to behave.

All the demo projects create a subset of the common demo tasks, the implementations of which are contained in the FreeRTOS/Demo/Common/Minimal directory. The common demo tasks exist purely to demonstrate how the FreeRTOS API can be used—they do not implement any particular useful functionality.

More recent demo projects can also build a beginners 'blinky' project. Blinky projects are very basic. Typically they will create just two tasks and one queue.

Every demo project includes a file called main.c. This contains the main() function, from where all the demo application tasks are created. See the comments within the individual main.c files for information specific to that demo.

The FreeRTOS/Demo directory hierarchy is shown in Figure 4.

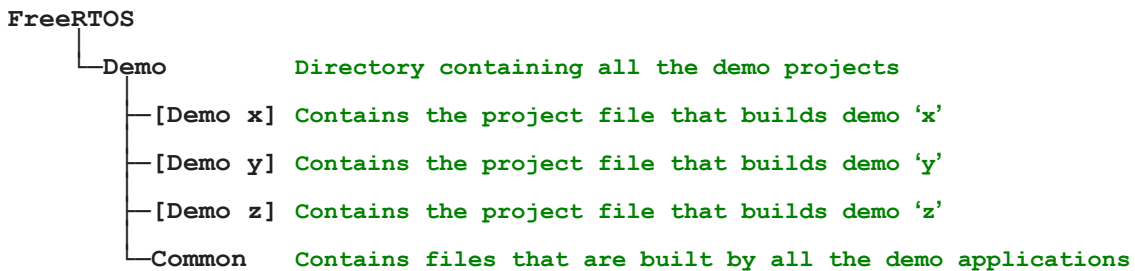

Figure 4. The demo directory hierarchy

1.4 Creating a FreeRTOS Project

Adapting One of the Supplied Demo Projects

Every FreeRTOS port comes with at least one pre-configured demo application that should build with no errors or warnings. It is recommended that new projects are created by adapting one of these existing projects; this will allow the project to have the correct files included, the correct interrupt handlers installed, and the correct compiler options set.

To start a new application from an existing demo project:

1. Open the supplied demo project and ensure that it builds and executes as expected.
2. Remove the source files that define the demo tasks. Any file that is located within the Demo/Common directory can be removed from the project.
3. Delete all the function calls within main(), except prvSetupHardware() and vTaskStartScheduler(), as shown in Listing 1.
4. Check the project still builds.

Following these steps will create a project that includes the correct FreeRTOS source files, but does not define any functionality.

```
int main( void )
{
    /* Perform any hardware setup necessary. */
    prvSetupHardware();

    /* --- APPLICATION TASKS CAN BE CREATED HERE --- */

    /* Start the created tasks running. */
    vTaskStartScheduler();

    /* Execution will only reach here if there was insufficient heap to
    start the scheduler. */
    for( ;; );
    return 0;
}
```

Listing 1. The template for a new main() function

Creating a New Project from Scratch

As already mentioned, it is recommended that new projects are created from an existing demo project. If this is not desirable, then a new project can be created using the following procedure:

1. Using your chosen tool chain, create a new project that does not yet include any FreeRTOS source files.
2. Ensure the new project can be built, downloaded to your target hardware, and executed.
3. Only when you are sure you already have a working project, add the FreeRTOS source files detailed in Table 1 to the project.
4. Copy the FreeRTOSConfig.h header file used by the demo project provided for the port in use into the project directory.
5. Add the following directories to the path the project will search to locate header files:
 - FreeRTOS/Source/include
 - FreeRTOS/Source/portable/[*compiler*]/[*architecture*] (where [*compiler*] and [*architecture*] are correct for your chosen port)
 - The directory containing the FreeRTOSConfig.h header file
6. Copy the compiler settings from the relevant demo project.
7. Install any FreeRTOS interrupt handlers that might be necessary. Use the web page that describes the port in use, and the demo project provided for the port in use, as a reference.

Table 1. FreeRTOS source files to include in the project

File	Location
tasks.c	FreeRTOS/Source
queue.c	FreeRTOS/Source
list.c	FreeRTOS/Source
timers.c	FreeRTOS/Source
event_groups.c	FreeRTOS/Source
All C and assembler files	FreeRTOS/Source/portable/[compiler]/[architecture]
heap_n.c	FreeRTOS/Source/portable/MemMang, where n is either 1, 2, 3, 4 or 5. This file became optional from FreeRTOS V9.0.0.

Projects that use a FreeRTOS version older than V9.0.0 must build one of the heap_n.c files. From FreeRTOS V9.0.0 a heap_n.c file is only required if configSUPPORT_DYNAMIC_ALLOCATION is set to 1 in FreeRTOSConfig.h or if configSUPPORT_DYNAMIC_ALLOCATION is left undefined. Refer to Chapter 2, Heap Memory Management, for more information.

1.5 Data Types and Coding Style Guide

Data Types

Each port of FreeRTOS has a unique portmacro.h header file that contains (amongst other things) definitions for two port specific data types: TickType_t and BaseType_t. These data types are described in Table 2.

Table 2. Port specific data types used by FreeRTOS

Macro or typedef used	Actual type
TickType_t	<p>FreeRTOS configures a periodic interrupt called the tick interrupt.</p> <p>The number of tick interrupts that have occurred since the FreeRTOS application started is called the <i>tick count</i>. The tick count is used as a measure of time.</p> <p>The time between two tick interrupts is called the <i>tick period</i>. Times are specified as multiples of tick periods.</p> <p>TickType_t is the data type used to hold the tick count value, and to specify times.</p> <p>TickType_t can be either an unsigned 16-bit type, or an unsigned 32-bit type, depending on the setting of configUSE_16_BIT_TICKS within FreeRTOSConfig.h. If configUSE_16_BIT_TICKS is set to 1, then TickType_t is defined as uint16_t. If configUSE_16_BIT_TICKS is set to 0 then TickType_t is defined as uint32_t.</p> <p>Using a 16-bit type can greatly improve efficiency on 8-bit and 16-bit architectures, but severely limits the maximum block period that can be specified. There is no reason to use a 16-bit type on a 32-bit architecture.</p>

Table 2. Port specific data types used by FreeRTOS

Macro or typedef used	Actual type
BaseType_t	This is always defined as the most efficient data type for the architecture. Typically, this is a 32-bit type on a 32-bit architecture, a 16-bit type on a 16-bit architecture, and an 8-bit type on an 8-bit architecture. BaseType_t is generally used for return types that can take only a very limited range of values, and for pdTRUE/pdFALSE type Booleans.

Some compilers make all unqualified char variables unsigned, while others make them signed. For this reason, the FreeRTOS source code explicitly qualifies every use of char with either 'signed' or 'unsigned', unless the char is used to hold an ASCII character, or a pointer to char is used to point to a string.

Plain int types are never used.

Variable Names

Variables are prefixed with their type: 'c' for char, 's' for int16_t (short), 'l' int32_t (long), and 'x' for BaseType_t and any other non-standard types (structures, task handles, queue handles, etc.).

If a variable is unsigned, it is also prefixed with a 'u'. If a variable is a pointer, it is also prefixed with a 'p'. For example, a variable of type uint8_t will be prefixed with 'uc', and a variable of type pointer to char will be prefixed with 'pc'.

Function Names

Functions are prefixed with both the type they return, and the file they are defined within. For example:

- yTaskPrioritySet() returns a yoid and is defined within **task.c**.
- xQueueReceive() returns a variable of type BaseType_t and is defined within **queue.c**.
- pvTimerGetTimerID() returns a pointer to yoid and is defined within **timers.c**.

File scope (private) functions are prefixed with 'prv'.

Formatting

One tab is always set to equal four spaces.

Macro Names

Most macros are written in upper case, and prefixed with lower case letters that indicate where the macro is defined. Table 3 provides a list of prefixes.

Table 3. Macro prefixes

Prefix	Location of macro definition
port (for example, portMAX_DELAY)	portable.h or portmacro.h
task (for example, taskENTER_CRITICAL())	task.h
pd (for example, pdTRUE)	projdefs.h
config (for example, configUSE_PREEMPTION)	FreeRTOSConfig.h
err (for example, errQUEUE_FULL)	projdefs.h

Note that the semaphore API is written almost entirely as a set of macros, but follows the function naming convention, rather than the macro naming convention.

The macros defined in Table 4 are used throughout the FreeRTOS source code.

Table 4. Common macro definitions

Macro	Value
pdTRUE	1
pdFALSE	0
pdPASS	1
pdFAIL	0

Rationale for Excessive Type Casting

The FreeRTOS source code can be compiled with many different compilers, all of which differ in how and when they generate warnings. In particular, different compilers want casting to be used in different ways. As a result, the FreeRTOS source code contains more type casting than would normally be warranted.

Chapter 2

Heap Memory Management

From FreeRTOS V9.0.0 FreeRTOS applications can be completely statically allocated, removing the need to include a heap memory manager

2.1 Chapter Introduction and Scope

Prerequisites

FreeRTOS is provided as a set of C source files, so being a competent C programmer is a prerequisite for using FreeRTOS, and therefore this chapter assumes the reader is familiar with concepts such as:

- How a C project is built, including the different compiling and linking phases.
- What the stack and heap are.
- The standard C library `malloc()` and `free()` functions.

Dynamic Memory Allocation and its Relevance to FreeRTOS

From FreeRTOS V9.0.0 kernel objects can be allocated statically at compile time, or dynamically at run time: Following chapters of this book will introduce kernel objects such as tasks, queues, semaphores and event groups. To make FreeRTOS as easy to use as possible, these kernel objects are not statically allocated at compile-time, but dynamically allocated at run-time; FreeRTOS allocates RAM each time a kernel object is created, and frees RAM each time a kernel object is deleted. This policy reduces design and planning effort, simplifies the API, and minimizes the RAM footprint.

This chapter discusses dynamic memory allocation. Dynamic memory allocation is a C programming concept, and not a concept that is specific to either FreeRTOS or multitasking. It is relevant to FreeRTOS because kernel objects are allocated dynamically, and the dynamic memory allocation schemes provided by general purpose compilers are not always suitable for real-time applications.

Memory can be allocated using the standard C library `malloc()` and `free()` functions, but they may not be suitable, or appropriate, for one or more of the following reasons:

- They are not always available on small embedded systems.
- Their implementation can be relatively large, taking up valuable code space.
- They are rarely thread-safe.

- They are not deterministic; the amount of time taken to execute the functions will differ from call to call.
- They can suffer from fragmentation¹.
- They can complicate the linker configuration.
- They can be the source of difficult to debug errors if the heap space is allowed to grow into memory used by other variables.

Options for Dynamic Memory Allocation

From FreeRTOS V9.0.0 kernel objects can be allocated statically at compile time, or dynamically at run time: Early versions of FreeRTOS used a memory pools allocation scheme, whereby pools of different size memory blocks were pre-allocated at compile time, then returned by the memory allocation functions. Although this is a common scheme to use in real-time systems, it proved to be the source of many support requests, predominantly because it could not use RAM efficiently enough to make it viable for really small embedded systems—so the scheme was dropped.

FreeRTOS now treats memory allocation as part of the portable layer (as opposed to part of the core code base). This is in recognition of the fact that different embedded systems have varying dynamic memory allocation and timing requirements, so a single dynamic memory allocation algorithm will only ever be appropriate for a subset of applications. Also, removing dynamic memory allocation from the core code base enables application writer's to provide their own specific implementations, when appropriate.

When FreeRTOS requires RAM, instead of calling `malloc()`, it calls `pvPortMalloc()`. When RAM is being freed, instead of calling `free()`, the kernel calls `vPortFree()`. `pvPortMalloc()` has the same prototype as the standard C library `malloc()` function, and `vPortFree()` has the same prototype as the standard C library `free()` function.

`pvPortMalloc()` and `vPortFree()` are public functions, so can also be called from application code.

¹ The heap is considered to be fragmented if the free RAM within the heap is broken up into small blocks that are separated from each other. If the heap is fragmented, then an attempt to allocate a block will fail if no single free block in the heap is large enough to contain the block, even if the total size of all the separate free blocks in the heap is many times greater than the size of the block that cannot be allocated.

From FreeRTOS V9.0.0 kernel objects can be allocated statically at compile time, or dynamically at run time: FreeRTOS comes with five example implementations of both `pvPortMalloc()` and `vPortFree()`, all of which are documented in this chapter. FreeRTOS applications can use one of the example implementations, or provide their own.

The five examples are defined in the `heap_1.c`, `heap_2.c`, `heap_3.c`, `heap_4.c` and `heap_5.c` source files respectively, all of which are located in the `FreeRTOS/Source/portable/MemMang` directory.

Scope

This chapter aims to give readers a good understanding of:

- When FreeRTOS allocates RAM.
- The five example memory allocation schemes supplied with FreeRTOS.
- Which memory allocation scheme to select.

2.2 Example Memory Allocation Schemes

From FreeRTOS V9.0.0 FreeRTOS applications can be completely statically allocated, removing the need to include a heap memory manager

Heap_1

It is common for small dedicated embedded systems to only create tasks and other kernel objects before the scheduler has been started. When this is the case, memory only gets dynamically allocated by the kernel before the application starts to perform any real-time functionality, and the memory remains allocated for the lifetime of the application. This means the chosen allocation scheme does not have to consider any of the more complex memory allocation issues, such as determinism and fragmentation, and can instead just consider attributes such as code size and simplicity.

Heap_1.c implements a very basic version of `pvPortMalloc()`, and does not implement `vPortFree()`. Applications that never delete a task, or other kernel object, have the potential to use heap_1.

Some commercially critical and safety critical systems that would otherwise prohibit the use of dynamic memory allocation also have the potential to use heap_1. Critical systems often prohibit dynamic memory allocation because of the uncertainties associated with non-determinism, memory fragmentation, and failed allocations—but Heap_1 is always deterministic, and cannot fragment memory.

The heap_1 allocation scheme subdivides a simple array into smaller blocks, as calls to `pvPortMalloc()` are made. The array is called the FreeRTOS heap.

The total size (in bytes) of the array is set by the definition `configTOTAL_HEAP_SIZE` within `FreeRTOSConfig.h`. Defining a large array in this manner can make the application appear to consume a lot of RAM—even before any memory has been allocated from the array.

Each created task requires a task control block (TCB) and a stack to be allocated from the heap. Figure 5 demonstrates how heap_1 subdivides the simple array as tasks are created.

Referring to Figure 5:

- A shows the array before any tasks have been created—the entire array is free.

- B shows the array after one task has been created.
- C shows the array after three tasks have been created.

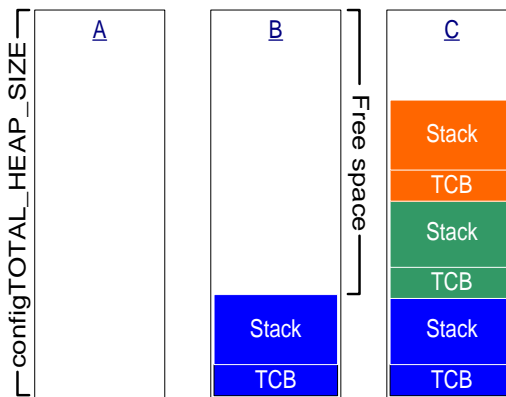

Figure 5. RAM being allocated from the heap_1 array each time a task is created

Heap_2

Heap_2 is retained in the FreeRTOS distribution for backward compatibility, but its use is not recommended for new designs. Consider using heap_4 instead of heap_2, as heap_4 provides enhanced functionality.

Heap_2.c also works by subdividing an array that is dimensioned by `configTOTAL_HEAP_SIZE`. It uses a best fit algorithm to allocate memory and, unlike heap_1, it does allow memory to be freed. Again, the array is statically declared, so will make the application appear to consume a lot of RAM, even before any memory from the array has been assigned.

The best fit algorithm ensures that `pvPortMalloc()` uses the free block of memory that is closest in size to the number of bytes requested. For example, consider the scenario where:

- The heap contains three blocks of free memory that are 5 bytes, 25 bytes, and 100 bytes, respectively.
- `pvPortMalloc()` is called to request 20 bytes of RAM.

The smallest free block of RAM into which the requested number of bytes will fit is the 25-byte block, so `pvPortMalloc()` splits the 25-byte block into one block of 20 bytes and one block of 5

bytes¹, before returning a pointer to the 20-byte block. The new 5-byte block remains available to future calls to pvPortMalloc().

Unlike heap_4, Heap_2 does not combine adjacent free blocks into a single larger block, so it is more susceptible to fragmentation. However, fragmentation is not an issue if the blocks being allocated and subsequently freed are always the same size. Heap_2 is suitable for an application that creates and deletes tasks repeatedly, provided the size of the stack allocated to the created tasks does not change.

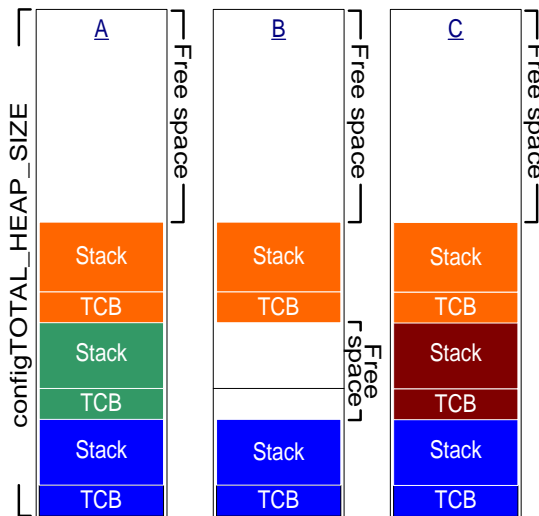

Figure 6. RAM being allocated and freed from the heap_2 array as tasks are created and deleted

Figure 6 demonstrates how the best fit algorithm works when a task is created, deleted, and then created again. Referring to Figure 6:

1. A shows the array after three tasks have been created. A large free block remains at the top of the array.
2. B shows the array after one of the tasks has been deleted. The large free block at the top of the array remains. There are now also two smaller free blocks that were previously allocated to the TCB and stack of the deleted task.
3. C shows the situation after another task has been created. Creating the task has resulted in two calls to pvPortMalloc(), one to allocate a new TCB, and one to allocate the task stack. Tasks are created using the xTaskCreate() API function, which is

¹ This is an oversimplification, because heap_2 stores information on the block sizes within the heap area, so the sum of the two split blocks will actually be less than 25.

described in section 3.4. The calls to `pvPortMalloc()` occur internally within `xTaskCreate()`.

Every TCB is exactly the same size, so the best fit algorithm ensures that the block of RAM previously allocated to the TCB of the deleted task is reused to allocate the TCB of the new task.

The size of the stack allocated to the newly created task is identical to that allocated to the previously deleted task, so the best fit algorithm ensures that the block of RAM previously allocated to the stack of the deleted task is reused to allocate the stack of the new task.

The larger unallocated block at the top of the array remains untouched.

Heap_2 is not deterministic, but is faster than most standard library implementations of `malloc()` and `free()`.

Heap_3

Heap_3.c uses the standard library `malloc()` and `free()` functions, so the size of the heap is defined by the linker configuration, and the `configTOTAL_HEAP_SIZE` setting has no affect.

Heap_3 makes `malloc()` and `free()` thread-safe by temporarily suspending the FreeRTOS scheduler. Thread safety, and scheduler suspension, are both topics that are covered in Chapter 7, Resource Management.

Heap_4

Like `heap_1` and `heap_2`, `heap_4` works by subdividing an array into smaller blocks. As before, the array is statically declared, and dimensioned by `configTOTAL_HEAP_SIZE`, so will make the application appear to consume a lot of RAM, even before any memory has actually been allocated from the array.

Heap_4 uses a first fit algorithm to allocate memory. Unlike `heap_2`, `heap_4` combines (coalescences) adjacent free blocks of memory into a single larger block, which minimizes the risk of memory fragmentation.

The first fit algorithm ensures `pvPortMalloc()` uses the first free block of memory that is large enough to hold the number of bytes requested. For example, consider the scenario where:

- The heap contains three blocks of free memory that, in the order in which they appear in the array, are 5 bytes, 200 bytes, and 100 bytes, respectively.
- `pvPortMalloc()` is called to request 20 bytes of RAM.

The first free block of RAM into which the requested number of bytes will fit is the 200-byte block, so `pvPortMalloc()` splits the 200-byte block into one block of 20 bytes, and one block of 180 bytes¹, before returning a pointer to the 20-byte block. The new 180-byte block remains available to future calls to `pvPortMalloc()`.

`Heap_4` combines (coalescences) adjacent free blocks into a single larger block, minimizing the risk of fragmentation, and making it suitable for applications that repeatedly allocate and free different sized blocks of RAM.

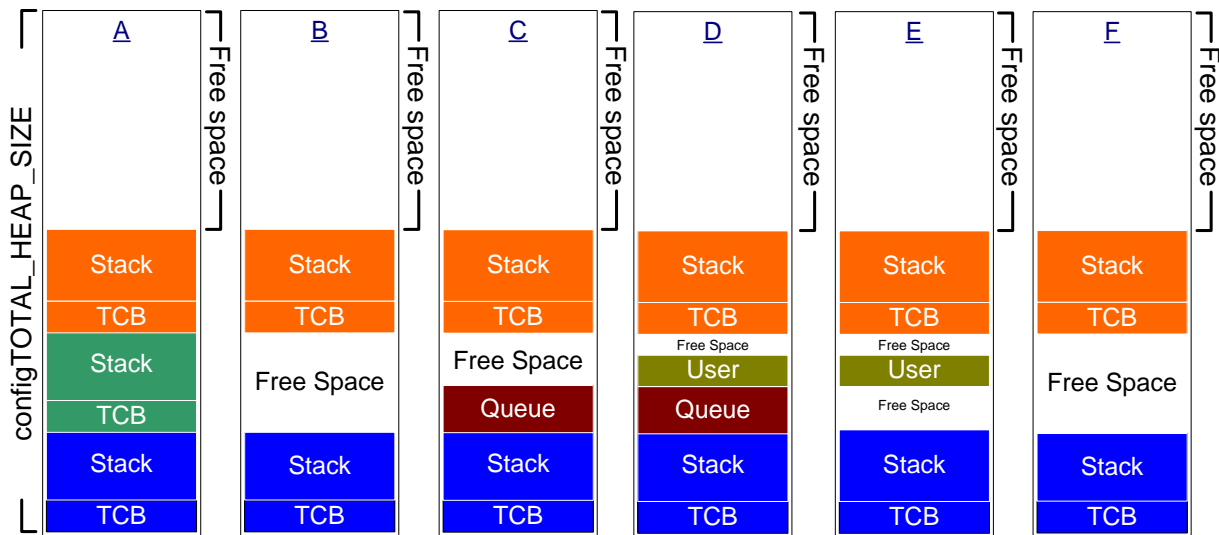

Figure 7. RAM being allocated and freed from the heap_4 array

Figure 7 demonstrates how the `heap_4` first fit algorithm with memory coalescence works, as memory is allocated and freed. Referring to Figure 7:

1. A shows the array after three tasks have been created. A large free block remains at the top of the array.
2. B shows the array after one of the tasks has been deleted. The large free block at the top of the array remains. There is also a free block where the TCB and stack of the

¹ This is an oversimplification, because `heap_4` stores information on the block sizes within the heap area, so the sum of the two split blocks will actually be less than 200 bytes.

task that has been deleted were previously allocated. Note that, unlike when heap_2 was demonstrated, the memory freed when the TCB was deleted, and the memory freed when the stack was deleted, does not remain as two separate free blocks, but is instead combined to create a larger single free block.

3. C shows the situation after a FreeRTOS queue has been created. Queues are created using the `xQueueCreate()` API function, which is described in section 4.3. `xQueueCreate()` calls `pvPortMalloc()` to allocate the RAM used by the queue. As heap_4 uses a first fit algorithm, `pvPortMalloc()` will allocate RAM from the first free RAM block that is large enough to hold the queue, which in Figure 7, was the RAM freed when the task was deleted. The queue does not consume all the RAM in the free block however, so the block is split into two, and the unused portion remains available to future calls to `pvPortMalloc()`.
4. D shows the situation after `pvPortMalloc()` has been called directly from application code, rather than indirectly by calling a FreeRTOS API function. The user allocated block was small enough to fit in the first free block, which was the block between the memory allocated to the queue, and the memory allocated to the following TCB.

The memory freed when the task was deleted has now been split into three separate blocks; the first block holds the queue, the second block holds the user allocated memory, and the third block remains free.

5. E show the situation after the queue has been deleted, which automatically frees the memory that had been allocated to the deleted queue. There is now free memory on either side of the user allocated block.
6. F shows the situation after the user allocated memory has also been freed. The memory that had been used by the user allocated block has been combined with the free memory on either side to create a larger single free block.

Heap_4 is not deterministic, but is faster than most standard library implementations of `malloc()` and `free()`.

Setting a Start Address for the Array Used By Heap_4

This section contains advanced level information. It is not necessary to read or understand this section in order to use Heap_4.

Sometimes it is necessary for an application writer to place the array used by heap_4 at a specific memory address. For example, the stack used by a FreeRTOS task is allocated from the heap, so it might be necessary to ensure the heap is located in fast internal memory, rather than slow external memory.

By default, the array used by heap_4 is declared inside the heap_4.c source file, and its start address is set automatically by the linker. However, if the configAPPLICATION_ALLOCATED_HEAP compile time configuration constant is set to 1 in FreeRTOSConfig.h, then the array must instead be declared by the application that is using FreeRTOS. If the array is declared as part of the application, then the application's writer can set its start address.

If configAPPLICATION_ALLOCATED_HEAP is set to 1 in FreeRTOSConfig.h, then a uint8_t array called ucHeap, and dimensioned by the configTOTAL_HEAP_SIZE setting, must be declared in one of the application's source files.

The syntax required to place a variable at a specific memory address is dependent on the compiler in use, so refer to your compiler's documentation. Examples for two compilers follow:

- Listing 2 shows the syntax required by the GCC compiler to declare the array, and place the array in a memory section called .my_heap.
- Listing 3 shows the syntax required by the IAR compiler to declare the array, and place the array at the absolute memory address 0x20000000.

```
uint8_t ucHeap[ configTOTAL_HEAP_SIZE ] __attribute__ ( ( section( ".my_heap" ) ) );
```

Listing 2. Using GCC syntax to declare the array that will be used by heap_4, and place the array in a memory section named .my_heap

```
uint8_t ucHeap[ configTOTAL_HEAP_SIZE ] @ 0x20000000;
```

Listing 3. Using IAR syntax to declare the array that will be used by heap_4, and place the array at the absolute address 0x20000000

Heap_5

The algorithm used by heap_5 to allocate and free memory is identical to that used by heap_4. Unlike heap_4, heap_5 is not limited to allocating memory from a single statically declared array; heap_5 can allocate memory from multiple and separated memory spaces. Heap_5 is

useful when the RAM provided by the system on which FreeRTOS is running does not appear as a single contiguous (without space) block in the system's memory map.

At the time of writing, heap_5 is the only provided memory allocation scheme that must be explicitly initialized before pvPortMalloc() can be called. Heap_5 is initialized using the vPortDefineHeapRegions() API function. When heap_5 is used, vPortDefineHeapRegions() must be called before any kernel objects (tasks, queues, semaphores, etc.) can be created.

The vPortDefineHeapRegions() API Function

vPortDefineHeapRegions() is used to specify the start address and size of each separate memory area that together makes up the total memory used by heap_5.

```
void vPortDefineHeapRegions( const HeapRegion_t * const pxHeapRegions );
```

Listing 4. The vPortDefineHeapRegions() API function prototype

Each separate memory areas is described by a structure of type HeapRegion_t. A description of all the available memory areas is passed into vPortDefineHeapRegions() as an array of HeapRegion_t structures.

```
typedef struct HeapRegion
{
    /* The start address of a block of memory that will be part of the heap.*/
    uint8_t *pucStartAddress;

    /* The size of the block of memory in bytes. */
    size_t xSizeInBytes;
} HeapRegion_t;
```

Listing 5. The HeapRegion_t structure

Table 5. vPortDefineHeapRegions() parameters

Parameter Name/ Returned Value	Description
pxHeapRegions	<p>A pointer to the start of an array of HeapRegion_t structures. Each structure in the array describes the start address and length of a memory area that will be part of the heap when heap_5 is used.</p> <p>The HeapRegion_t structures in the array must be ordered by start address; the HeapRegion_t structure that describes the memory area with the lowest start address must be the first structure in the array, and the HeapRegion_t structure that describes the memory area with the highest start address must be the last structure in the array.</p> <p>The end of the array is marked by a HeapRegion_t structure that has its pucStartAddress member set to NULL.</p>

By way of example, consider the hypothetical memory map shown in Figure 8 **A**, which contains three separate blocks of RAM: RAM1, RAM2 and RAM3. It is assumed executable code is placed in read only memory, which is not shown.

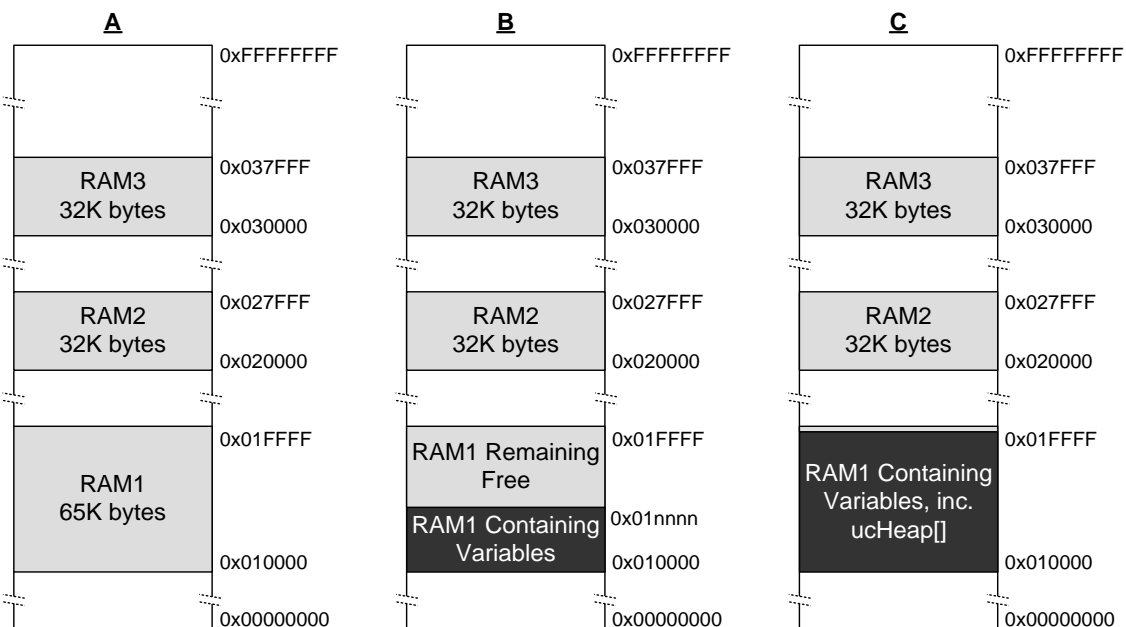

Figure 8 Memory Map

Listing 6 shows an array of HeapRegion_t structures that together describe the three blocks of RAM in their entirety.

```
/* Define the start address and size of the three RAM regions. */
#define RAM1_START_ADDRESS    ( ( uint8_t * ) 0x00010000 )
#define RAM1_SIZE             ( 65 * 1024 )

#define RAM2_START_ADDRESS    ( ( uint8_t * ) 0x00020000 )
#define RAM2_SIZE             ( 32 * 1024 )

#define RAM3_START_ADDRESS    ( ( uint8_t * ) 0x00030000 )
#define RAM3_SIZE             ( 32 * 1024 )

/* Create an array of HeapRegion_t definitions, with an index for each of the three
RAM regions, and terminating the array with a NULL address. The HeapRegion_t
structures must appear in start address order, with the structure that contains the
lowest start address appearing first. */
const HeapRegion_t xHeapRegions[] =
{
    { RAM1_START_ADDRESS, RAM1_SIZE },
    { RAM2_START_ADDRESS, RAM2_SIZE },
    { RAM3_START_ADDRESS, RAM3_SIZE },
    { NULL,                0          } /* Marks the end of the array. */
};

int main( void )
{
    /* Initialize heap_5. */
    vPortDefineHeapRegions( xHeapRegions );

    /* Add application code here. */
}
```

Listing 6. An array of HeapRegion_t structures that together describe the 3 regions of RAM in their entirety

While Listing 6 correctly describes the RAM, it does not demonstrate a usable example, because it allocates all the RAM to the heap, leaving no RAM free for use by other variables.

When a project is built, the linking phase of the build process allocates a RAM address to each variable. The RAM available for use by the linker is normally described by a linker configuration file, such as a linker script. In Figure 8 **B** it is assumed the linker script included information on RAM1, but did not include information on RAM2 or RAM3. The linker has therefore placed variables in RAM1, leaving only the portion of RAM1 above address 0x0001nnnn available for use by heap_5. The actual value of 0x0001nnnn will depend on the combined size of all the variables included in the application being linked. The linker has left all of RAM2 and all of RAM3 unused, leaving the whole of RAM2 and the whole of RAM3 available for use by heap_5.

If the code shown in Listing 6 was used, the RAM allocated to heap_5 below address 0x0001nnnn would overlap the RAM used to hold variables. To avoid that, the first HeapRegion_t structure within the xHeapRegions[] array could use a start address of 0x0001nnnn, rather than a start address of 0x00010000. However, that is not a recommended solution because:

1. The start address might not be easy to determine.
2. The amount of RAM used by the linker might change in future builds, necessitating an update to the start address used in the HeapRegion_t structure.
3. The build tools will not know, and therefore cannot warn the application writer, if the RAM used by the linker and the RAM used by heap_5 overlap.

Listing 7 demonstrates a more convenient and maintainable example. It declares an array called ucHeap. ucHeap is a normal variable, so it becomes part of the data allocated to RAM1 by the linker. The first HeapRegion_t structure in the xHeapRegions array describes the start address and size of ucHeap, so ucHeap becomes part of the memory managed by heap_5. The size of ucHeap can be increased until the RAM used by the linker consumes all of RAM1, as shown in Figure 8 **C**.

```

/* Define the start address and size of the two RAM regions not used by the
linker. */
#define RAM2_START_ADDRESS    ( ( uint8_t * ) 0x00020000 )
#define RAM2_SIZE             ( 32 * 1024 )

#define RAM3_START_ADDRESS    ( ( uint8_t * ) 0x00030000 )
#define RAM3_SIZE             ( 32 * 1024 )

/* Declare an array that will be part of the heap used by heap_5.  The array will be
placed in RAM1 by the linker. */
#define RAM1_HEAP_SIZE ( 30 * 1024 )
static uint8_t ucHeap[ RAM1_HEAP_SIZE ];

/* Create an array of HeapRegion_t definitions.  Whereas in Listing 6 the first entry
described all of RAM1, so heap_5 will have used all of RAM1, this time the first
entry only describes the ucHeap array, so heap_5 will only use the part of RAM1 that
contains the ucHeap array.  The HeapRegion_t structures must still appear in start
address order, with the structure that contains the lowest start address appearing
first. */
const HeapRegion_t xHeapRegions[] =
{
    { ucHeap,                RAM1_HEAP_SIZE },
    { RAM2_START_ADDRESS,   RAM2_SIZE },
    { RAM3_START_ADDRESS,   RAM3_SIZE },
    { NULL,                  0 } /* Marks the end of the array. */
};

```

Listing 7. An array of HeapRegion_t structures that describe all of RAM2, all of RAM3, but only part of RAM1

The advantages of the technique demonstrated in Listing 7 include:

1. It is not necessary to use a hard coded start address.
2. The address used in the HeapRegion_t structure will be set automatically, by the linker, so will always be correct, even if the amount of RAM used by the linker changes in future builds.
3. It is not possible for RAM allocated to heap_5 to overlap data placed into RAM1 by the linker.
4. The application will not link if ucHeap is too big.

2.3 Heap Related Utility Functions

The xPortGetFreeHeapSize() API Function

The xPortGetFreeHeapSize() API function returns the number of free bytes in the heap at the time the function is called. It can be used to optimize the heap size. For example, if xPortGetFreeHeapSize() returns 2000 after all the kernel objects have been created, then the value of configTOTAL_HEAP_SIZE can be reduced by 2000.

xPortGetFreeHeapSize() is not available when heap_3 is used.

```
size_t xPortGetFreeHeapSize( void );
```

Listing 8. The xPortGetFreeHeapSize() API function prototype

Table 6. xPortGetFreeHeapSize() return value

Parameter Name/ Returned Value	Description
Returned value	The number of bytes that remain unallocated in the heap at the time xPortGetFreeHeapSize() is called.

The xPortGetMinimumEverFreeHeapSize() API Function

The xPortGetMinimumEverFreeHeapSize() API function returns the minimum number of unallocated bytes that have ever existed in the heap since the FreeRTOS application started executing.

The value returned by xPortGetMinimumEverFreeHeapSize() is an indication of how close the application has ever come to running out of heap space. For example, if xPortGetMinimumEverFreeHeapSize() returns 200, then, at some time since the application started executing, it came within 200 bytes of running out of heap space.

xPortGetMinimumEverFreeHeapSize() is only available when heap_4 or heap_5 is used.

```
size_t xPortGetMinimumEverFreeHeapSize( void );
```

Listing 9. The xPortGetMinimumEverFreeHeapSize() API function prototype

Table 7. xPortGetMinimumEverFreeHeapSize() return value

Parameter Name/ Returned Value	Description
Returned value	The minimum number of unallocated bytes that have existed in the heap since the FreeRTOS application started executing.

Malloc Failed Hook Functions

pvPortMalloc() can be called directly from application code. It is also called within FreeRTOS source files each time a kernel object is created. Examples of kernel objects include tasks, queues, semaphores, and event groups—all of which are described in later chapters of this book.

Just like the standard library malloc() function, if pvPortMalloc() cannot return a block of RAM because a block of the requested size does not exist, then it will return NULL. If pvPortMalloc() is executed because the application writer is creating a kernel object, and the call to pvPortMalloc() returns NULL, then the kernel object will not be created.

All the example heap allocation schemes can be configured to call a hook (or callback) function if a call to pvPortMalloc() returns NULL.

If configUSE_MALLOC_FAILED_HOOK is set to 1 in FreeRTOSConfig.h, then the application must provide a malloc failed hook function that has the name and prototype shown by Listing 10. The function can be implemented in any way that is appropriate for the application.

```
void vApplicationMallocFailedHook( void );
```

Listing 10. The malloc failed hook function name and prototype.

Chapter 3

Task Management

3.1 Chapter Introduction and Scope

Scope

This chapter aims to give readers a good understanding of:

- How FreeRTOS allocates processing time to each task within an application.
- How FreeRTOS chooses which task should execute at any given time.
- How the relative priority of each task affects system behavior.
- The states that a task can exist in.

Readers should also gain a good understanding of:

- How to implement tasks.
- How to create one or more instances of a task.
- How to use the task parameter.
- How to change the priority of a task that has already been created.
- How to delete a task.
- How to implement periodic processing using a task (software timers are discussed in a later chapter).
- When the idle task will execute and how it can be used.

The concepts presented in this chapter are fundamental to understanding how to use FreeRTOS, and how FreeRTOS applications behave. This is, therefore, the most detailed chapter in the book.

3.2 Task Functions

Tasks are implemented as C functions. The only thing special about them is their prototype, which must return void and take a void pointer parameter. The prototype is demonstrated by Listing 11.

```
void ATaskFunction( void *pvParameters );
```

Listing 11. The task function prototype

Each task is a small program in its own right. It has an entry point, will normally run forever within an infinite loop, and will not exit. The structure of a typical task is shown in Listing 12.

FreeRTOS tasks must not be allowed to return from their implementing function in any way—they must not contain a 'return' statement and must not be allowed to execute past the end of the function. If a task is no longer required, it should instead be explicitly deleted. This is also demonstrated in Listing 12.

A single task function definition can be used to create any number of tasks—each created task being a separate execution instance, with its own stack and its own copy of any automatic (stack) variables defined within the task itself.

```

void ATaskFunction( void *pvParameters )
{
/* Variables can be declared just as per a normal function. Each instance of a task
created using this example function will have its own copy of the lVariableExample
variable. This would not be true if the variable was declared static - in which case
only one copy of the variable would exist, and this copy would be shared by each
created instance of the task. (The prefixes added to variable names are described in
section 1.5, Data Types and Coding Style Guide.) */
int32_t lVariableExample = 0;

/* A task will normally be implemented as an infinite loop. */
for( ;; )
{
/* The code to implement the task functionality will go here. */
}

/* Should the task implementation ever break out of the above loop, then the task
must be deleted before reaching the end of its implementing function. The NULL
parameter passed to the vTaskDelete() API function indicates that the task to be
deleted is the calling (this) task. The convention used to name API functions is
described in section 0, Projects that use a FreeRTOS version older than V9.0.0
must build one of the heap_n.c files. From FreeRTOS V9.0.0 a heap_n.c file is only
required if configSUPPORT_DYNAMIC_ALLOCATION is set to 1 in FreeRTOSConfig.h or if
configSUPPORT_DYNAMIC_ALLOCATION is left undefined. Refer to Chapter 2, Heap Memory
Management, for more information.
Data Types and Coding Style Guide. */
vTaskDelete( NULL );
}

```

Listing 12. The structure of a typical task function

3.3 Top Level Task States

An application can consist of many tasks. If the processor running the application contains a single core, then only one task can be executing at any given time. This implies that a task can exist in one of two states, Running and Not Running. This simplistic model is considered first—but keep in mind that it is an over simplification. Later in the chapter it is shown that the Not Running state actually contains a number of sub-states.

When a task is in the Running state the processor is executing the task's code. When a task is in the Not Running state, the task is dormant, its status having been saved ready for it to resume execution the next time the scheduler decides it should enter the Running state. When a task resumes execution, it does so from the instruction it was about to execute before it last left the Running state.

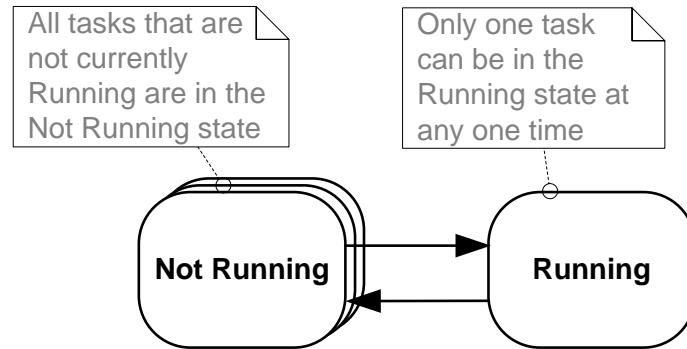

Figure 9. Top level task states and transitions

A task transitioned from the Not Running state to the Running state is said to have been 'switched in' or 'swapped in'. Conversely, a task transitioned from the Running state to the Not Running state is said to have been 'switched out' or 'swapped out'. The FreeRTOS scheduler is the only entity that can switch a task in and out.

3.4 Creating Tasks

The xTaskCreate() API Function

FreeRTOS V9.0.0 also includes the `xTaskCreateStatic()` function, which allocates the memory required to create a task statically at compile time: Tasks are created using the FreeRTOS `xTaskCreate()` API function. This is probably the most complex of all the API functions, so it is unfortunate that it is the first encountered, but tasks must be mastered first as they are the most fundamental component of a multitasking system. All the examples that accompany this book make use of the `xTaskCreate()` function, so there are plenty of examples to reference.

Section 1.5, Data Types and Coding Style Guide, describes the data types and naming conventions used.

```
BaseType_t xTaskCreate( TaskFunction_t pvTaskCode,
                       const char * const pcName,
                       uint16_t usStackDepth,
                       void *pvParameters,
                       UBaseType_t uxPriority,
                       TaskHandle_t *pxCreatedTask );
```

Listing 13. The `xTaskCreate()` API function prototype

Table 8. `xTaskCreate()` parameters and return value

Parameter Name/ Returned Value	Description
<code>pvTaskCode</code>	Tasks are simply C functions that never exit and, as such, are normally implemented as an infinite loop. The <code>pvTaskCode</code> parameter is simply a pointer to the function that implements the task (in effect, just the name of the function).

Table 8. xTaskCreate() parameters and return value

Parameter Name/ Returned Value	Description
pcName	<p>A descriptive name for the task. This is not used by FreeRTOS in any way. It is included purely as a debugging aid. Identifying a task by a human readable name is much simpler than attempting to identify it by its handle.</p> <p>The application-defined constant configMAX_TASK_NAME_LEN defines the maximum length a task name can take—including the NULL terminator. Supplying a string longer than this maximum will result in the string being silently truncated.</p>

Table 8. xTaskCreate() parameters and return value

Parameter Name/ Returned Value	Description
usStackDepth	<p>Each task has its own unique stack that is allocated by the kernel to the task when the task is created. The usStackDepth value tells the kernel how large to make the stack.</p> <p>The value specifies the number of words the stack can hold, not the number of bytes. For example, if the stack is 32-bits wide and usStackDepth is passed in as 100, then 400 bytes of stack space will be allocated (100 * 4 bytes). The stack depth multiplied by the stack width must not exceed the maximum value that can be contained in a variable of type uint16_t.</p> <p>The size of the stack used by the Idle task is defined by the application-defined constant configMINIMAL_STACK_SIZE¹. The value assigned to this constant in the FreeRTOS demo application for the processor architecture being used is the minimum recommended for any task. If your task uses a lot of stack space, then you must assign a larger value.</p> <p>There is no easy way to determine the stack space required by a task. It is possible to calculate, but most users will simply assign what they think is a reasonable value, then use the features provided by FreeRTOS to ensure that the space allocated is indeed adequate, and that RAM is not being wasted unnecessarily. Section 12.3, Stack Overflow, contains information on how to query the maximum stack space that has actually been used by a task.</p>
pvParameters	<p>Task functions accept a parameter of type pointer to void (void*). The value assigned to pvParameters is the value passed into the task. Some examples in this book demonstrate how the parameter can be used.</p>

¹ This is the only way the FreeRTOS source code uses the configMINIMAL_STACK_SIZE setting, although the constant is also used inside demo applications to help make the demos portable across multiple processor architectures.

Table 8. xTaskCreate() parameters and return value

Parameter Name/ Returned Value	Description
uxPriority	<p>Defines the priority at which the task will execute. Priorities can be assigned from 0, which is the lowest priority, to (configMAX_PRIORITIES – 1), which is the highest priority. configMAX_PRIORITIES is a user defined constant that is described in section 3.5.</p> <p>Passing a uxPriority value above (configMAX_PRIORITIES – 1) will result in the priority assigned to the task being capped silently to the maximum legitimate value.</p>
pxCreatedTask	<p>pxCreatedTask can be used to pass out a handle to the task being created. This handle can then be used to reference the task in API calls that, for example, change the task priority or delete the task.</p> <p>If your application has no use for the task handle, then pxCreatedTask can be set to NULL.</p>
Returned value	<p>There are two possible return values:</p> <ol style="list-style-type: none">1. pdPASS <p>This indicates that the task has been created successfully.</p>2. pdFAIL <p>This indicates that the task has not been created because there is insufficient heap memory available for FreeRTOS to allocate enough RAM to hold the task data structures and stack.</p><p>Chapter 2 provides more information on heap memory management.</p>

Example 1. Creating tasks

This example demonstrates the steps needed to create two simple tasks, then start the tasks executing. The tasks simply print out a string periodically, using a crude null loop to create the

period delay. Both tasks are created at the same priority, and are identical except for the string they print out—see Listing 14 and Listing 15 for their respective implementations.

```
void vTask1( void *pvParameters )
{
const char *pcTaskName = "Task 1 is running\r\n";
volatile uint32_t ul; /* volatile to ensure ul is not optimized away. */

    /* As per most tasks, this task is implemented in an infinite loop. */
    for( ;; )
    {
        /* Print out the name of this task. */
        vPrintString( pcTaskName );

        /* Delay for a period. */
        for( ul = 0; ul < mainDELAY_LOOP_COUNT; ul++ )
        {
            /* This loop is just a very crude delay implementation. There is
            nothing to do in here. Later examples will replace this crude
            loop with a proper delay/sleep function. */
        }
    }
}
```

Listing 14. Implementation of the first task used in Example 1

```
void vTask2( void *pvParameters )
{
const char *pcTaskName = "Task 2 is running\r\n";
volatile uint32_t ul; /* volatile to ensure ul is not optimized away. */

    /* As per most tasks, this task is implemented in an infinite loop. */
    for( ;; )
    {
        /* Print out the name of this task. */
        vPrintString( pcTaskName );

        /* Delay for a period. */
        for( ul = 0; ul < mainDELAY_LOOP_COUNT; ul++ )
        {
            /* This loop is just a very crude delay implementation. There is
            nothing to do in here. Later examples will replace this crude
            loop with a proper delay/sleep function. */
        }
    }
}
```

Listing 15. Implementation of the second task used in Example 1

The main() function creates the tasks before starting the scheduler—see Listing 16 for its implementation.

```
int main( void )
{
    /* Create one of the two tasks. Note that a real application should check
    the return value of the xTaskCreate() call to ensure the task was created
    successfully. */
    xTaskCreate(    vTask1, /* Pointer to the function that implements the task. */
                  "Task 1", /* Text name for the task. This is to facilitate
                             debugging only. */
                  1000, /* Stack depth - small microcontrollers will use much
                             less stack than this. */
                  NULL, /* This example does not use the task parameter. */
                  1, /* This task will run at priority 1. */
                  NULL ); /* This example does not use the task handle. */

    /* Create the other task in exactly the same way and at the same priority. */
    xTaskCreate( vTask2, "Task 2", 1000, NULL, 1, NULL );

    /* Start the scheduler so the tasks start executing. */
    vTaskStartScheduler();

    /* If all is well then main() will never reach here as the scheduler will
    now be running the tasks. If main() does reach here then it is likely that
    there was insufficient heap memory available for the idle task to be created.
    Chapter 2 provides more information on heap memory management. */
    for( ;; );
}
```

Listing 16. Starting the Example 1 tasks

Executing the example produces the output shown in Figure 10.

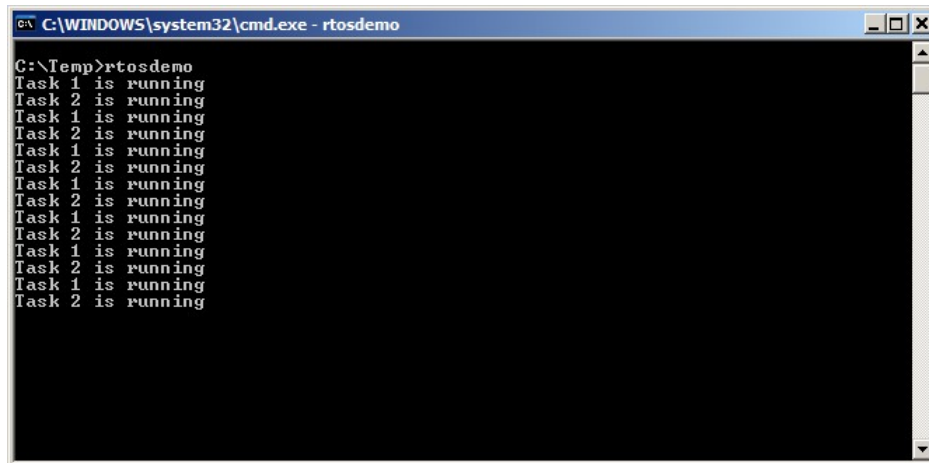

Figure 10. The output produced when Example 1 is executed¹

¹ The screen shot shows each task printing out its message exactly once before the next task executes. This is an artificial scenario that results from using the FreeRTOS Windows simulator. The Windows simulator is not truly real time. Also writing to the Windows console takes a relatively long time and results in a chain of Windows system calls. Executing the same code on a genuine embedded target with a fast and non-blocking print function may result in each task printing its string many times before being switched out to allow the other task to run.

Figure 10 shows the two tasks appearing to execute simultaneously; however, as both tasks are executing on the same processor core, this cannot be the case. In reality, both tasks are rapidly entering and exiting the Running state. Both tasks are running at the same priority, and so share time on the same processor core. Their actual execution pattern is shown in Figure 11.

The arrow along the bottom of Figure 11 shows the passing of time from time t1 onwards. The colored lines show which task is executing at each point in time—for example, Task 1 is executing between time t1 and time t2.

Only one task can exist in the Running state at any one time. So, as one task enters the Running state (the task is switched in), the other enters the Not Running state (the task is switched out).

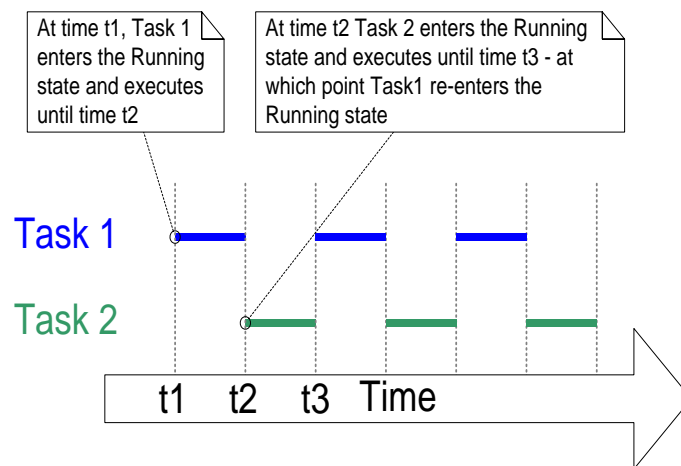

Figure 11. The actual execution pattern of the two Example 1 tasks

Example 1 created both tasks from within main(), prior to starting the scheduler. It is also possible to create a task from within another task. For example, Task 2 could have been created from within Task 1, as shown by Listing 17.

```
void vTask1( void *pvParameters )
{
const char *pcTaskName = "Task 1 is running\r\n";
volatile uint32_t ul; /* volatile to ensure ul is not optimized away. */

/* If this task code is executing then the scheduler must already have
been started. Create the other task before entering the infinite loop. */
xTaskCreate( vTask2, "Task 2", 1000, NULL, 1, NULL );

for( ;; )
{
/* Print out the name of this task. */
vPrintString( pcTaskName );

/* Delay for a period. */
for( ul = 0; ul < mainDELAY_LOOP_COUNT; ul++ )
{
/* This loop is just a very crude delay implementation. There is
nothing to do in here. Later examples will replace this crude
loop with a proper delay/sleep function. */
}
}
}
```

Listing 17. Creating a task from within another task after the scheduler has started

Example 2. Using the task parameter

The two tasks created in Example 1 are almost identical, the only difference between them being the text string they print out. This duplication can be removed by, instead, creating two instances of a single task implementation. The task parameter can then be used to pass into each task the string that it should print out.

Listing 18 contains the code of the single task function (vTaskFunction) used by Example 2. This single function replaces the two task functions (vTask1 and vTask2) used in Example 1. Note how the task parameter is cast to a char * to obtain the string the task should print out.

```
void vTaskFunction( void *pvParameters )
{
char *pcTaskName;
volatile uint32_t ul; /* volatile to ensure ul is not optimized away. */

/* The string to print out is passed in via the parameter. Cast this to a
character pointer. */
pcTaskName = ( char * ) pvParameters;

/* As per most tasks, this task is implemented in an infinite loop. */
for( ;; )
{
/* Print out the name of this task. */
vPrintString( pcTaskName );

/* Delay for a period. */
for( ul = 0; ul < mainDELAY_LOOP_COUNT; ul++ )
{
/* This loop is just a very crude delay implementation. There is
nothing to do in here. Later exercises will replace this crude
loop with a proper delay/sleep function. */
}
}
}
```

Listing 18. The single task function used to create two tasks in Example 2

Even though there is now only one task implementation (vTaskFunction), more than one instance of the defined task can be created. Each created instance will execute independently under the control of the FreeRTOS scheduler.

Listing 19 shows how the pvParameters parameter to the xTaskCreate() function is used to pass the text string into the task.

```
/* Define the strings that will be passed in as the task parameters. These are
defined const and not on the stack to ensure they remain valid when the tasks are
executing. */
static const char *pcTextForTask1 = "Task 1 is running\r\n";
static const char *pcTextForTask2 = "Task 2 is running\r\n";

int main( void )
{
    /* Create one of the two tasks. */
    xTaskCreate(    vTaskFunction,          /* Pointer to the function that
                                                implements the task. */
                  "Task 1",              /* Text name for the task. This is to
                                                facilitate debugging only. */
                  1000,                  /* Stack depth - small microcontrollers
                                                will use much less stack than this. */
                  (void*)pcTextForTask1, /* Pass the text to be printed into the
                                                task using the task parameter. */
                  1,                      /* This task will run at priority 1. */
                  NULL );                 /* The task handle is not used in this
                                                example. */

    /* Create the other task in exactly the same way. Note this time that multiple
tasks are being created from the SAME task implementation (vTaskFunction). Only
the value passed in the parameter is different. Two instances of the same
task are being created. */
    xTaskCreate( vTaskFunction, "Task 2", 1000, (void*)pcTextForTask2, 1, NULL );

    /* Start the scheduler so the tasks start executing. */
    vTaskStartScheduler();

    /* If all is well then main() will never reach here as the scheduler will
now be running the tasks. If main() does reach here then it is likely that
there was insufficient heap memory available for the idle task to be created.
Chapter 2 provides more information on heap memory management. */
    for( ;; );
}
```

Listing 19. The main() function for Example 2.

The output from Example 2 is exactly as per that shown for example 1 in Figure 10.

3.5 Task Priorities

The `uxPriority` parameter of the `xTaskCreate()` API function assigns an initial priority to the task being created. The priority can be changed after the scheduler has been started by using the `vTaskPrioritySet()` API function.

The maximum number of priorities available is set by the application-defined `configMAX_PRIORITIES` compile time configuration constant within `FreeRTOSConfig.h`. Low numeric priority values denote low-priority tasks, with priority 0 being the lowest priority possible. Therefore, the range of available priorities is 0 to $(\text{configMAX_PRIORITIES} - 1)$. Any number of tasks can share the same priority—ensuring maximum design flexibility.

The FreeRTOS scheduler can use one of two methods to decide which task will be in the Running state. The maximum value to which `configMAX_PRIORITIES` can be set depends on the method used:

1. Generic Method

The generic method is implemented in C, and can be used with all the FreeRTOS architecture ports.

When the generic method is used, FreeRTOS does not limit the maximum value to which `configMAX_PRIORITIES` can be set. However, it is always advisable to keep the `configMAX_PRIORITIES` value at the minimum necessary, because the higher its value, the more RAM will be consumed, and the longer the worst case execution time will be.

The generic method will be used if `configUSE_PORT_OPTIMISED_TASK_SELECTION` is set to 0 in `FreeRTOSConfig.h`, or if `configUSE_PORT_OPTIMISED_TASK_SELECTION` is left undefined, or if the generic method is the only method provided for the FreeRTOS port in use.

2. Architecture Optimized Method

The architecture optimized method uses a small amount of assembler code, and is faster than the generic method. The `configMAX_PRIORITIES` setting does not affect the worst case execution time.

If the architecture optimized method is used then configMAX_PRIORITIES cannot be greater than 32. As with the generic method, it is advisable to keep configMAX_PRIORITIES at the minimum necessary, as the higher its value, the more RAM will be consumed.

The architecture optimized method will be used if configUSE_PORT_OPTIMISED_TASK_SELECTION is set to 1 in FreeRTOSConfig.h.

Not all FreeRTOS ports provide an architecture optimized method.

The FreeRTOS scheduler will always ensure that the highest priority task that is able to run is the task selected to enter the Running state. Where more than one task of the same priority is able to run, the scheduler will transition each task into and out of the Running state, in turn.

3.6 Time Measurement and the Tick Interrupt

Section 3.12, Scheduling Algorithms, describes an optional feature called ‘time slicing’. Time slicing was used in the examples presented so far, and is the behavior observed in the output they produced. In the examples, both tasks were created at the same priority, and both tasks were always able to run. Therefore, each task executed for a ‘time slice’, entering the Running state at the start of a time slice, and exiting the Running state at the end of a time slice. In Figure 11, the time between t1 and t2 equals a single time slice.

To be able to select the next task to run, the scheduler itself must execute at the end of each time slice¹. A periodic interrupt, called the ‘tick interrupt’, is used for this purpose. The length of the time slice is effectively set by the tick interrupt frequency, which is configured by the application-defined `configTICK_RATE_HZ` compile time configuration constant within `FreeRTOSConfig.h`. For example, if `configTICK_RATE_HZ` is set to 100 (Hz), then the time slice will be 10 milliseconds. The time between two tick interrupts is called the ‘tick period’. One time slice equals one tick period.

Figure 11 can be expanded to show the execution of the scheduler itself in the sequence of execution. This is shown in Figure 12, in which the top line shows when the scheduler is executing, and the thin arrows show the sequence of execution from a task to the tick interrupt, then from the tick interrupt back to a different task.

The optimal value for `configTICK_RATE_HZ` is dependent on the application being developed, although a value of 100 is typical.

¹ It is important to note that the end of a time slice is not the only place that the scheduler can select a new task to run; as will be demonstrated throughout this book, the scheduler will also select a new task to run immediately after the currently executing task enters the Blocked state, or when an interrupt moves a higher priority task into the Ready state.

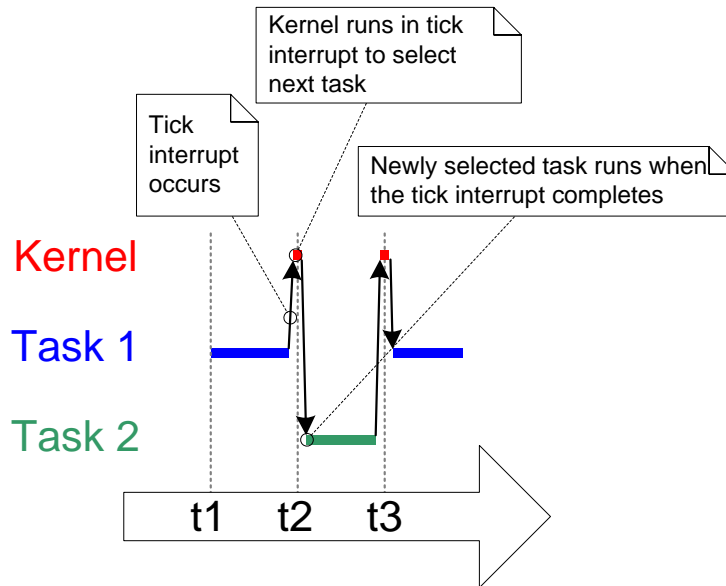

Figure 12. The execution sequence expanded to show the tick interrupt executing

FreeRTOS API calls always specify time in multiples of tick periods, which are often referred to simply as 'ticks'. The `pdMS_TO_TICKS()` macro converts a time specified in milliseconds into a time specified in ticks. The resolution available depends on the defined tick frequency, and `pdMS_TO_TICKS()` cannot be used if the tick frequency is above 1KHz (if `configTICK_RATE_HZ` is greater than 1000). Listing 20 shows how to use `pdMS_TO_TICKS()` to convert a time specified as 200 milliseconds into an equivalent time specified in ticks.

```
/* pdMS_TO_TICKS() takes a time in milliseconds as its only parameter, and evaluates
to the equivalent time in tick periods. This example shows xTimeInTicks being set to
the number of tick periods that are equivalent to 200 milliseconds. */
TickType_t xTimeInTicks = pdMS_TO_TICKS( 200 );
```

Listing 20. Using the `pdMS_TO_TICKS()` macro to convert 200 milliseconds into an equivalent time in tick periods

Note: It is not recommended to specify times in ticks directly within the application, but instead to use the `pdMS_TO_TICKS()` macro to specify times in milliseconds, and in so doing, ensuring times specified within the application do not change if the tick frequency is changed.

The 'tick count' value is the total number of tick interrupts that have occurred since the scheduler was started, assuming the tick count has not overflowed. User applications do not have to consider overflows when specifying delay periods, as time consistency is managed internally by FreeRTOS.

Section 3.12, Scheduling Algorithms, describes configuration constants that affect when the scheduler will select a new task to run, and when a tick interrupt will execute.

Example 3. Experimenting with priorities

The scheduler will always ensure that the highest priority task that is able to run is the task selected to enter the Running state. In our examples so far, two tasks have been created at the same priority, so both entered and exited the Running state in turn. This example looks at what happens when the priority of one of the two tasks created in Example 2 is changed. This time, the first task will be created at priority 1, and the second at priority 2. The code to create the tasks is shown in Listing 21. The single function that implements both tasks has not changed; it still simply prints out a string periodically, using a null loop to create a delay.

```
/* Define the strings that will be passed in as the task parameters. These are
defined const and not on the stack to ensure they remain valid when the tasks are
executing. */
static const char *pcTextForTask1 = "Task 1 is running\r\n";
static const char *pcTextForTask2 = "Task 2 is running\r\n";

int main( void )
{
    /* Create the first task at priority 1. The priority is the second to last
    parameter. */
    xTaskCreate( vTaskFunction, "Task 1", 1000, (void*)pcTextForTask1, 1, NULL );

    /* Create the second task at priority 2, which is higher than a priority of 1.
    The priority is the second to last parameter. */
    xTaskCreate( vTaskFunction, "Task 2", 1000, (void*)pcTextForTask2, 2, NULL );

    /* Start the scheduler so the tasks start executing. */
    vTaskStartScheduler();

    /* Will not reach here. */
    return 0;
}
```

Listing 21. Creating two tasks at different priorities

The output produced by Example 3 is shown in Figure 13.

The scheduler will always select the highest priority task that is able to run. Task 2 has a higher priority than Task 1 and is always able to run; therefore, Task 2 is the only task to ever enter the Running state. As Task 1 never enters the Running state, it never prints out its string. Task 1 is said to be ‘starved’ of processing time by Task 2.

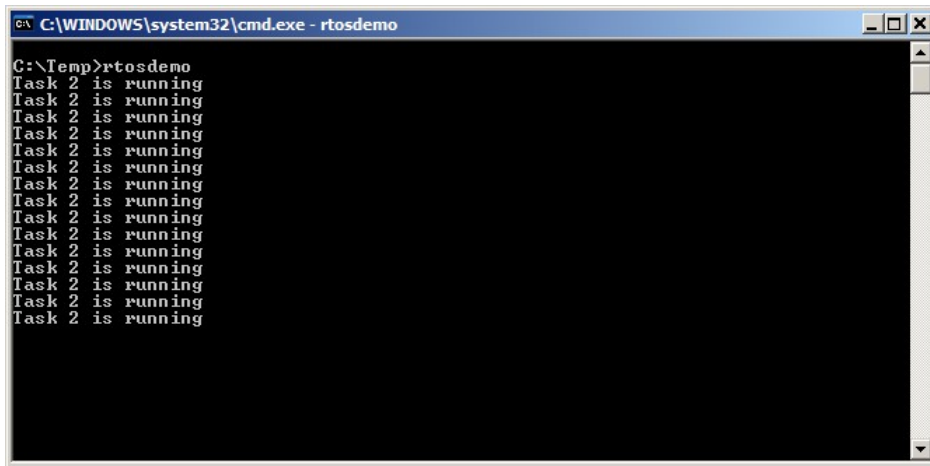

Figure 13. Running both tasks at different priorities

Task 2 is always able to run because it never has to wait for anything—it is either cycling around a null loop, or printing to the terminal.

Figure 14 shows the execution sequence for Example 3.

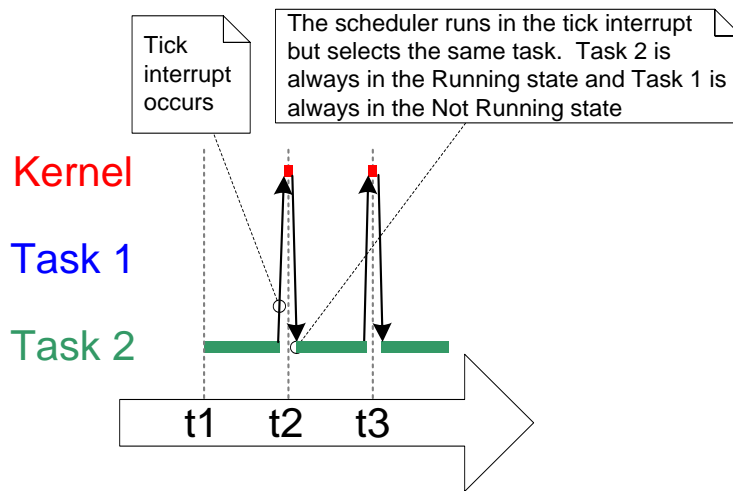

Figure 14. The execution pattern when one task has a higher priority than the other

3.7 Expanding the ‘Not Running’ State

So far, the created tasks have always had processing to perform and have never had to wait for anything—as they never have to wait for anything, they are always able to enter the Running state. This type of ‘continuous processing’ task has limited usefulness, because they can only be created at the very lowest priority. If they run at any other priority, they will prevent tasks of lower priority ever running at all.

To make the tasks useful they must be re-written to be event-driven. An event-driven task has work (processing) to perform only after the occurrence of the event that triggers it, and is not able to enter the Running state before that event has occurred. The scheduler always selects the highest priority task that is able to run. High priority tasks not being able to run means that the scheduler cannot select them and must, instead, select a lower priority task that is able to run. Therefore, using event-driven tasks means that tasks can be created at different priorities without the highest priority tasks starving all the lower priority tasks of processing time.

The Blocked State

A task that is waiting for an event is said to be in the ‘Blocked’ state, which is a sub-state of the Not Running state.

Tasks can enter the Blocked state to wait for two different types of event:

1. Temporal (time-related) events—the event being either a delay period expiring, or an absolute time being reached. For example, a task may enter the Blocked state to wait for 10 milliseconds to pass.
2. Synchronization events—where the events originate from another task or interrupt. For example, a task may enter the Blocked state to wait for data to arrive on a queue. Synchronization events cover a broad range of event types.

FreeRTOS queues, binary semaphores, counting semaphores, mutexes, recursive mutexes, event groups and direct to task notifications can all be used to create synchronization events. All these features are covered in future chapters of this book.

It is possible for a task to block on a synchronization event with a timeout, effectively blocking on both types of event simultaneously. For example, a task may choose to wait for a

maximum of 10 milliseconds for data to arrive on a queue. The task will leave the Blocked state if either data arrives within 10 milliseconds, or 10 milliseconds pass with no data arriving.

The Suspended State

'Suspended' is also a sub-state of Not Running. Tasks in the Suspended state are not available to the scheduler. The only way into the Suspended state is through a call to the `vTaskSuspend()` API function, the only way out being through a call to the `vTaskResume()` or `xTaskResumeFromISR()` API functions. Most applications do not use the Suspended state.

The Ready State

Tasks that are in the Not Running state but are not Blocked or Suspended are said to be in the Ready state. They are able to run, and therefore 'ready' to run, but are not currently in the Running state.

Completing the State Transition Diagram

Figure 15 expands on the previous over-simplified state diagram to include all the Not Running sub-states described in this section. The tasks created in the examples so far have not used the Blocked or Suspended states; they have only transitioned between the Ready state and the Running state—highlighted by the bold lines in Figure 15.

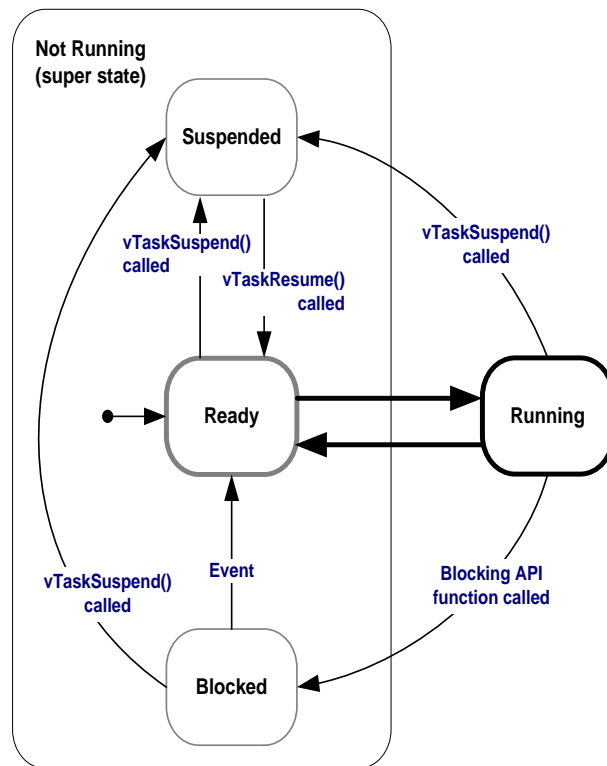

Figure 15. Full task state machine

Example 4. Using the Blocked state to create a delay

All the tasks created in the examples presented so far have been ‘periodic’—they have delayed for a period and printed out their string, before delaying once more, and so on. The delay has been generated very crudely using a null loop—the task effectively polled an incrementing loop counter until it reached a fixed value. Example 3 clearly demonstrated the disadvantage of this method. The higher priority task remained in the Running state while it executed the null loop, ‘starving’ the lower priority task of any processing time.

There are several other disadvantages to any form of polling, not least of which is its inefficiency. During polling, the task does not really have any work to do, but it still uses maximum processing time, and so wastes processor cycles. Example 4 corrects this behavior by replacing the polling null loop with a call to the `vTaskDelay()` API function, the prototype for which is shown in Listing 22. The new task definition is shown in Listing 23. Note that the `vTaskDelay()` API function is available only when `INCLUDE_vTaskDelay` is set to 1 in `FreeRTOSConfig.h`.

`vTaskDelay()` places the calling task into the Blocked state for a fixed number of tick interrupts. The task does not use any processing time while it is in the Blocked state, so the task only uses processing time when there is actually work to be done.

```
void vTaskDelay( TickType_t xTicksToDelay );
```

Listing 22. The vTaskDelay() API function prototype

Table 9. vTaskDelay() parameters

Parameter Name	Description
xTicksToDelay	<p>The number of tick interrupts that the calling task will remain in the Blocked state before being transitioned back into the Ready state.</p> <p>For example, if a task called vTaskDelay(100) when the tick count was 10,000, then it would immediately enter the Blocked state, and remain in the Blocked state until the tick count reached 10,100.</p> <p>The macro pdMS_TO_TICKS() can be used to convert a time specified in milliseconds into a time specified in ticks. For example, calling vTaskDelay(pdMS_TO_TICKS(100)) will result in the calling task remaining in the Blocked state for 100 milliseconds.</p>

```

void vTaskFunction( void *pvParameters )
{
char *pcTaskName;
const TickType_t xDelay250ms = pdMS_TO_TICKS( 250 );

/* The string to print out is passed in via the parameter. Cast this to a
character pointer. */
pcTaskName = ( char * ) pvParameters;

/* As per most tasks, this task is implemented in an infinite loop. */
for( ;; )
{
/* Print out the name of this task. */
vPrintString( pcTaskName );

/* Delay for a period. This time a call to vTaskDelay() is used which places
the task into the Blocked state until the delay period has expired. The
parameter takes a time specified in 'ticks', and the pdMS_TO_TICKS() macro
is used (where the xDelay250ms constant is declared) to convert 250
milliseconds into an equivalent time in ticks. */
vTaskDelay( xDelay250ms );
}
}

```

Listing 23. The source code for the example task after the null loop delay has been replaced by a call to vTaskDelay()

Even though the two tasks are still being created at different priorities, both will now run. The output of Example 4, which is shown in Figure 16, confirms the expected behavior.

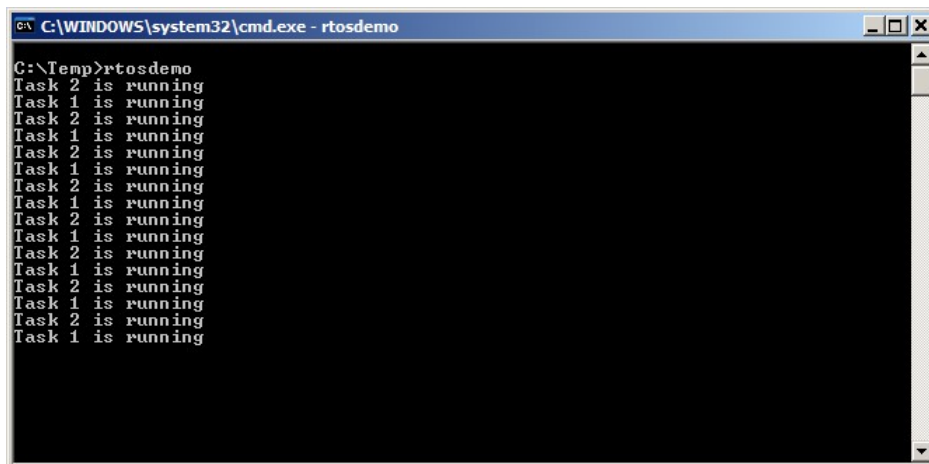

Figure 16. The output produced when Example 4 is executed

The execution sequence shown in Figure 17 explains why both tasks run, even though they are created at different priorities. The execution of the scheduler itself is omitted for simplicity.

The idle task is created automatically when the scheduler is started, to ensure there is always at least one task that is able to run (at least one task in the Ready state). Section 3.8, The Idle Task and the Idle Task Hook, describes the Idle task in more detail.

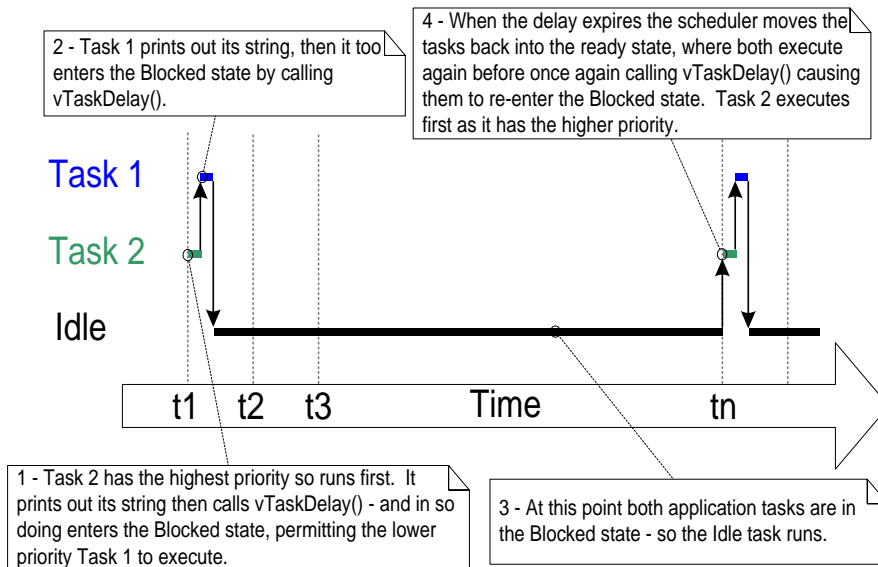

Figure 17. The execution sequence when the tasks use `vTaskDelay()` in place of the NULL loop

Only the implementation of the two tasks has changed, not their functionality. Comparing Figure 17 with Figure 12 demonstrates clearly that this functionality is being achieved in a much more efficient manner.

Figure 12 shows the execution pattern when the tasks use a null loop to create a delay—so are always able to run, and as a result use one hundred percent of the available processor time between them. Figure 17 shows the execution pattern when the tasks enter the Blocked state for the entirety of their delay period, so use processor time only when they actually have work that needs to be performed (in this case simply a message to be printed out), and as a result only use a tiny fraction of the available processing time.

In the Figure 17 scenario, each time the tasks leave the Blocked state they execute for a fraction of a tick period before re-entering the Blocked state. Most of the time there are no application tasks that are able to run (no application tasks in the Ready state) and, therefore, no application tasks that can be selected to enter the Running state. While this is the case, the idle task will run. The amount of processing time allocated to the idle is a measure of the spare processing capacity in the system. Using an RTOS can significantly increase the spare processing capacity simply by allowing an application to be completely event driven.

The bold lines in Figure 18 show the transitions performed by the tasks in Example 4, with each now transitioning through the Blocked state before being returned to the Ready state.

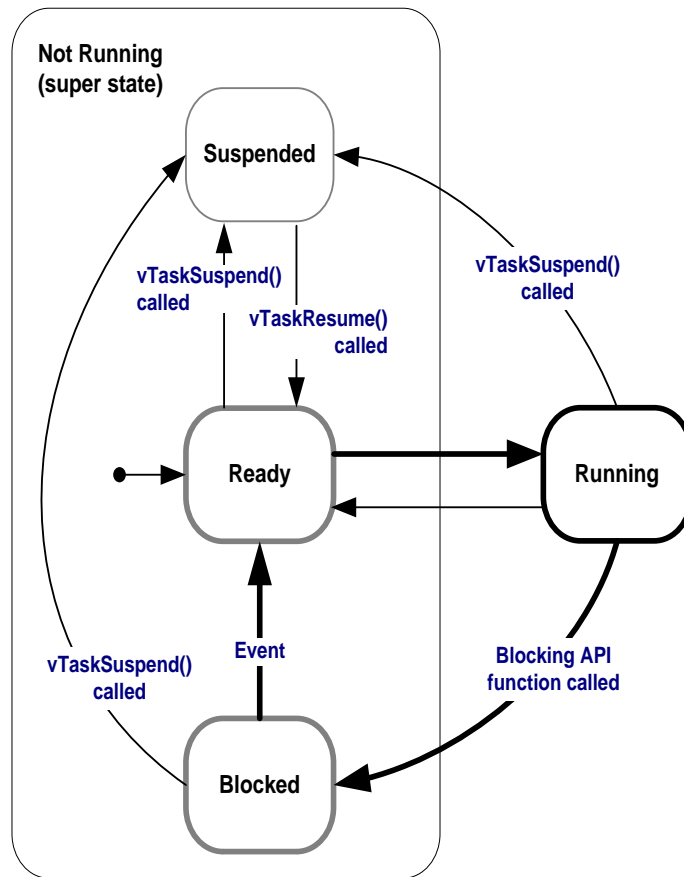

Figure 18. Bold lines indicate the state transitions performed by the tasks in Example 4

The vTaskDelayUntil() API Function

vTaskDelayUntil() is similar to vTaskDelay(). As just demonstrated, the vTaskDelay() parameter specifies the number of tick interrupts that should occur between a task calling vTaskDelay(), and the same task once again transitioning out of the Blocked state. The length of time the task remains in the blocked state is specified by the vTaskDelay() parameter, but the time at which the task leaves the blocked state is relative to the time at which vTaskDelay() was called.

The parameters to vTaskDelayUntil() specify, instead, the exact tick count value at which the calling task should be moved from the Blocked state into the Ready state. vTaskDelayUntil() is the API function that should be used when a fixed execution period is required (where you want your task to execute periodically with a fixed frequency), as the time at which the calling task is unblocked is absolute, rather than relative to when the function was called (as is the case with vTaskDelay()).

```
void vTaskDelayUntil( TickType_t * pxPreviousWakeTime, TickType_t xTimeIncrement );
```

Listing 24. vTaskDelayUntil() API function prototype

Table 10. vTaskDelayUntil() parameters

Parameter Name	Description
pxPreviousWakeTime	<p>This parameter is named on the assumption that vTaskDelayUntil() is being used to implement a task that executes periodically and with a fixed frequency. In this case, pxPreviousWakeTime holds the time at which the task last left the Blocked state (was ‘woken’ up). This time is used as a reference point to calculate the time at which the task should next leave the Blocked state.</p> <p>The variable pointed to by pxPreviousWakeTime is updated automatically within the vTaskDelayUntil() function; it would not normally be modified by the application code, but must be initialized to the current tick count before it is used for the first time. Listing 25 demonstrates how the initialization is performed.</p>
xTimeIncrement	<p>This parameter is also named on the assumption that vTaskDelayUntil() is being used to implement a task that executes periodically and with a fixed frequency—the frequency being set by the xTimeIncrement value.</p> <p>xTimeIncrement is specified in ‘ticks’. The macro pdMS_TO_TICKS() can be used to convert a time specified in milliseconds into a time specified in ticks.</p>

Example 5. Converting the example tasks to use vTaskDelayUntil()

The two tasks created in Example 4 are periodic tasks, but using vTaskDelay() does not guarantee that the frequency at which they run is fixed, as the time at which the tasks leave the Blocked state is relative to when they call vTaskDelay(). Converting the tasks to use vTaskDelayUntil() instead of vTaskDelay() solves this potential problem.

```

void vTaskFunction( void *pvParameters )
{
char *pcTaskName;
TickType_t xLastWakeTime;

    /* The string to print out is passed in via the parameter. Cast this to a
character pointer. */
pcTaskName = ( char * ) pvParameters;

    /* The xLastWakeTime variable needs to be initialized with the current tick
count. Note that this is the only time the variable is written to explicitly.
After this xLastWakeTime is automatically updated within vTaskDelayUntil(). */
xLastWakeTime = xTaskGetTickCount();

    /* As per most tasks, this task is implemented in an infinite loop. */
for( ;; )
{
    /* Print out the name of this task. */
vPrintString( pcTaskName );

    /* This task should execute every 250 milliseconds exactly. As per
the vTaskDelay() function, time is measured in ticks, and the
pdMS_TO_TICKS() macro is used to convert milliseconds into ticks.
xLastWakeTime is automatically updated within vTaskDelayUntil(), so is not
explicitly updated by the task. */
vTaskDelayUntil( &xLastWakeTime, pdMS_TO_TICKS( 250 ) );
}
}

```

Listing 25. The implementation of the example task using vTaskDelayUntil()

The output produced by Example 5 is exactly as per that shown for Example 4 in Figure 16.

Example 6. Combining blocking and non-blocking tasks

Previous examples have examined the behavior of both polling and blocking tasks in isolation. This example re-enforces the stated expected system behavior by demonstrating an execution sequence when the two schemes are combined, as follows.

1. Two tasks are created at priority 1. These do nothing other than continuously print out a string.

These tasks never make any API function calls that could cause them to enter the Blocked state, so are always in either the Ready or the Running state. Tasks of this nature are called ‘continuous processing’ tasks, as they always have work to do (albeit rather trivial work, in this case). The source for the continuous processing tasks is shown in Listing 26.

2. A third task is then created at priority 2, so above the priority of the other two tasks. The third task also just prints out a string, but this time periodically, so uses the

vTaskDelayUntil() API function to place itself into the Blocked state between each print iteration.

The source for the periodic task is shown in Listing 27.

```
void vContinuousProcessingTask( void *pvParameters )
{
    char *pcTaskName;

    /* The string to print out is passed in via the parameter. Cast this to a
    character pointer. */
    pcTaskName = ( char * ) pvParameters;

    /* As per most tasks, this task is implemented in an infinite loop. */
    for( ;; )
    {
        /* Print out the name of this task. This task just does this repeatedly
        without ever blocking or delaying. */
        vPrintString( pcTaskName );
    }
}
```

Listing 26. The continuous processing task used in Example 6

```
void vPeriodicTask( void *pvParameters )
{
    TickType_t xLastWakeTime;
    const TickType_t xDelay3ms = pdMS_TO_TICKS( 3 );

    /* The xLastWakeTime variable needs to be initialized with the current tick
    count. Note that this is the only time the variable is explicitly written to.
    After this xLastWakeTime is managed automatically by the vTaskDelayUntil()
    API function. */
    xLastWakeTime = xTaskGetTickCount();

    /* As per most tasks, this task is implemented in an infinite loop. */
    for( ;; )
    {
        /* Print out the name of this task. */
        vPrintString( "Periodic task is running\r\n" );

        /* The task should execute every 3 milliseconds exactly - see the
        declaration of xDelay3ms in this function. */
        vTaskDelayUntil( &xLastWakeTime, xDelay3ms );
    }
}
```

Listing 27. The periodic task used in Example 6

Figure 19 shows the output produced by Example 6, with an explanation of the observed behavior given by the execution sequence shown in Figure 20.

```

C:\Windows\system32\cmd.exe
Continuous task 2 running
Continuous task 2 running
Periodic task is running
Continuous task 1 running
Continuous task 1 running
Continuous task 1 running
Continuous task 1 running
Continuous task 1 running
Continuous task 2 running
Continuous task 2 running
Continuous task 2 running
Continuous task 2 running
Continuous task 2 running
Continuous task 1 running
Continuous task 1 running
Continuous task 1 running
Continuous task 1 running
Continuous task 1 running
Continuous task 1 running
Continuous task 1 running
Continuous task 1 running
Continuous task 1 running
Periodic task is running
Continuous task 2 running
Continuous task 2 running

```

Figure 19. The output produced when Example 6 is executed

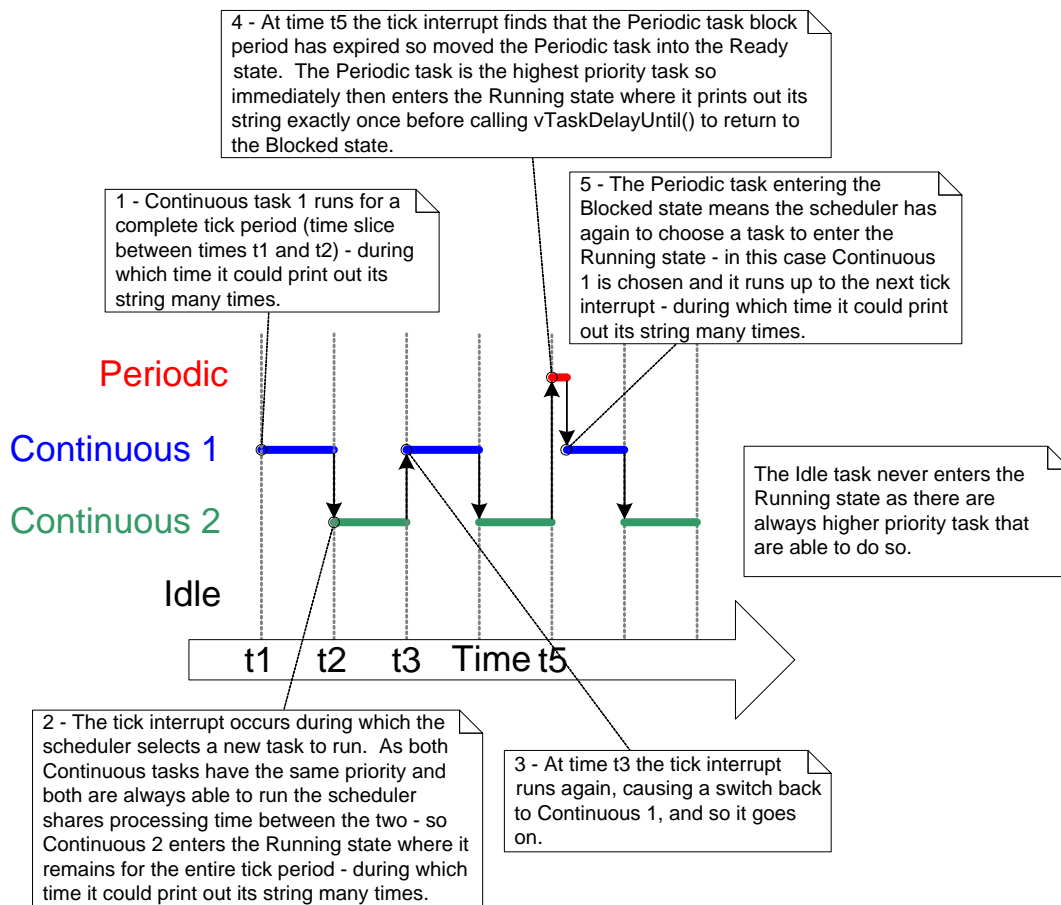

Figure 20. The execution pattern of Example 6

3.8 The Idle Task and the Idle Task Hook

The tasks created in Example 4 spend most of their time in the Blocked state. While in this state, they are not able to run, so cannot be selected by the scheduler.

There must always be at least one task that can enter the Running state¹. To ensure this is the case, an Idle task is automatically created by the scheduler when `vTaskStartScheduler()` is called. The idle task does very little more than sit in a loop—so, like the tasks in the original first examples, it is always able to run.

The idle task has the lowest possible priority (priority zero), to ensure it never prevents a higher priority application task from entering the Running state—although there is nothing to prevent application designers creating tasks at, and therefore sharing, the idle task priority, if desired. The `configIDLE_SHOULD_YIELD` compile time configuration constant in `FreeRTOSConfig.h` can be used to prevent the Idle task from consuming processing time that would be more productively allocated to applications tasks. `configIDLE_SHOULD_YIELD` is described in section 3.12, Scheduling Algorithms.

Running at the lowest priority ensures the Idle task is transitioned out of the Running state as soon as a higher priority task enters the Ready state. This can be seen at time *tn* in Figure 17, where the Idle task is immediately swapped out to allow Task 2 to execute at the instant Task 2 leaves the Blocked state. Task 2 is said to have pre-empted the idle task. Pre-emption occurs automatically, and without the knowledge of the task being pre-empted.

Note: If an application uses the `vTaskDelete()` API function then it is essential that the Idle task is not starved of processing time. This is because the Idle task is responsible for cleaning up kernel resources after a task has been deleted.

Idle Task Hook Functions

It is possible to add application specific functionality directly into the idle task through the use of an idle hook (or idle callback) function—a function that is called automatically by the idle task once per iteration of the idle task loop.

¹ This is the case even when the special low power features of FreeRTOS are being used, in which case the microcontroller on which FreeRTOS is executing will be placed into a low power mode if none of the tasks created by the application are able to execute.

Common uses for the Idle task hook include:

- Executing low priority, background, or continuous processing functionality.
- Measuring the amount of spare processing capacity. (The idle task will run only when all higher priority application tasks have no work to perform; so measuring the amount of processing time allocated to the idle task provides a clear indication of how much processing time is spare.)
- Placing the processor into a low power mode, providing an easy and automatic method of saving power whenever there is no application processing to be performed (although the power saving that can be achieved using this method is less than can be achieved by using the tick-less idle mode described in Chapter 10, Low Power Support).

Limitations on the Implementation of Idle Task Hook Functions

Idle task hook functions must adhere to the following rules.

1. An Idle task hook function must never attempt to block or suspend.

Note: Blocking the idle task in any way could cause a scenario where no tasks are available to enter the Running state.

2. If the application makes use of the `vTaskDelete()` API function, then the Idle task hook must always return to its caller within a reasonable time period. This is because the Idle task is responsible for cleaning up kernel resources after a task has been deleted. If the idle task remains permanently in the Idle hook function, then this clean-up cannot occur.

Idle task hook functions must have the name and prototype shown by Listing 28.

```
void vApplicationIdleHook( void );
```

Listing 28. The idle task hook function name and prototype

Example 7. Defining an idle task hook function

The use of blocking `vTaskDelay()` API calls in Example 4 created a lot of idle time—time when the Idle task is executing because both application tasks are in the Blocked state. Example 7

makes use of this idle time through the addition of an Idle hook function, the source for which is shown in Listing 29.

```
/* Declare a variable that will be incremented by the hook function. */
volatile uint32_t ulIdleCycleCount = 0UL;

/* Idle hook functions MUST be called vApplicationIdleHook(), take no parameters,
and return void. */
void vApplicationIdleHook( void )
{
    /* This hook function does nothing but increment a counter. */
    ulIdleCycleCount++;
}
```

Listing 29. A very simple Idle hook function

configUSE_IDLE_HOOK must be set to 1 in FreeRTOSConfig.h for the idle hook function to get called.

The function that implements the created tasks is modified slightly to print out the ulIdleCycleCount value, as shown in Listing 30.

```
void vTaskFunction( void *pvParameters )
{
    char *pcTaskName;
    const TickType_t xDelay250ms = pdMS_TO_TICKS( 250 );

    /* The string to print out is passed in via the parameter. Cast this to a
character pointer. */
    pcTaskName = ( char * ) pvParameters;

    /* As per most tasks, this task is implemented in an infinite loop. */
    for( ;; )
    {
        /* Print out the name of this task AND the number of times ulIdleCycleCount
has been incremented. */
        vPrintStringAndNumber( pcTaskName, ulIdleCycleCount );

        /* Delay for a period of 250 milliseconds. */
        vTaskDelay( xDelay250ms );
    }
}
```

Listing 30. The source code for the example task now prints out the ulIdleCycleCount value

The output produced by Example 7 is shown in Figure 21. It shows the idle task hook function is called approximately 4 million times between each iteration of the application tasks (the number of iterations is dependent on the speed of the hardware on which the demo is executed).

```
C:\WINDOWS\system32\cmd.exe - rtosdemo
C:\Temp>rtosdemo
Task 2 is running
uIdleCycleCount = 0
Task 1 is running
uIdleCycleCount = 0
Task 2 is running
uIdleCycleCount = 3869504
Task 1 is running
uIdleCycleCount = 3869504
Task 2 is running
uIdleCycleCount = 8564623
Task 1 is running
uIdleCycleCount = 8564623
Task 2 is running
uIdleCycleCount = 13181489
Task 1 is running
uIdleCycleCount = 13181489
Task 2 is running
uIdleCycleCount = 17838406
Task 1 is running
uIdleCycleCount = 17838406
```

Figure 21. The output produced when Example 7 is executed

3.9 Changing the Priority of a Task

The vTaskPrioritySet() API Function

The vTaskPrioritySet() API function can be used to change the priority of any task after the scheduler has been started. Note that the vTaskPrioritySet() API function is available only when INCLUDE_vTaskPrioritySet is set to 1 in FreeRTOSConfig.h.

```
void vTaskPrioritySet( TaskHandle_t pxTask, UBaseType_t uxNewPriority );
```

Listing 31. The vTaskPrioritySet() API function prototype

Table 11. vTaskPrioritySet() parameters

Parameter Name	Description
pxTask	The handle of the task whose priority is being modified (the subject task)—see the pxCreatedTask parameter of the xTaskCreate() API function for information on obtaining handles to tasks. A task can change its own priority by passing NULL in place of a valid task handle.
uxNewPriority	The priority to which the subject task is to be set. This is capped automatically to the maximum available priority of (configMAX_PRIORITIES – 1), where configMAX_PRIORITIES is a compile time constant set in the FreeRTOSConfig.h header file.

The uxTaskPriorityGet() API Function

The uxTaskPriorityGet() API function can be used to query the priority of a task. Note that the uxTaskPriorityGet() API function is available only when INCLUDE_uxTaskPriorityGet is set to 1 in FreeRTOSConfig.h.

```
UBaseType_t uxTaskPriorityGet( TaskHandle_t pxTask );
```

Listing 32. The uxTaskPriorityGet() API function prototype

Table 12. uxTaskPriorityGet() parameters and return value

Parameter Name/ Return Value	Description
pxTask	<p>The handle of the task whose priority is being queried (the subject task)—see the pxCreatedTask parameter of the xTaskCreate() API function for information on obtaining handles to tasks.</p> <p>A task can query its own priority by passing NULL in place of a valid task handle.</p>
Returned value	<p>The priority currently assigned to the task being queried.</p>

Example 8. Changing task priorities

The scheduler will always select the highest Ready state task as the task to enter the Running state. Example 8 demonstrates this by using the vTaskPrioritySet() API function to change the priority of two tasks relative to each other.

Example 8 creates two tasks at two different priorities. Neither task makes any API function calls that could cause it to enter the Blocked state, so both are always in either the Ready state or the Running state. Therefore, the task with the highest relative priority will always be the task selected by the scheduler to be in the Running state.

Example 8 behaves as follows:

1. Task 1 (Listing 33) is created with the highest priority, so is guaranteed to run first. Task 1 prints out a couple of strings before raising the priority of Task 2 (Listing 34) to above its own priority.
2. Task 2 starts to run (enters the Running state) as soon as it has the highest relative priority. Only one task can be in the Running state at any one time, so when Task 2 is in the Running state, Task 1 is in the Ready state.
3. Task 2 prints out a message before setting its own priority back down to below that of Task 1.
4. Task 2 setting its priority back down means Task 1 is once again the highest priority task, so Task 1 re-enters the Running state, forcing Task 2 back into the Ready state.

```
void vTask1( void *pvParameters )
{
    UBaseType_t uxPriority;

    /* This task will always run before Task 2 as it is created with the higher
    priority. Neither Task 1 nor Task 2 ever block so both will always be in
    either the Running or the Ready state.

    Query the priority at which this task is running - passing in NULL means
    "return the calling task's priority". */
    uxPriority = uxTaskPriorityGet( NULL );

    for( ;; )
    {
        /* Print out the name of this task. */
        vPrintString( "Task 1 is running\r\n" );

        /* Setting the Task 2 priority above the Task 1 priority will cause
        Task 2 to immediately start running (as then Task 2 will have the higher
        priority of the two created tasks). Note the use of the handle to task
        2 (xTask2Handle) in the call to vTaskPrioritySet(). Listing 35 shows how
        the handle was obtained. */
        vPrintString( "About to raise the Task 2 priority\r\n" );
        vTaskPrioritySet( xTask2Handle, ( uxPriority + 1 ) );

        /* Task 1 will only run when it has a priority higher than Task 2.
        Therefore, for this task to reach this point, Task 2 must already have
        executed and set its priority back down to below the priority of this
        task. */
    }
}
```

Listing 33. The implementation of Task 1 in Example 8

```

void vTask2( void *pvParameters )
{
  UBaseType_t uxPriority;

  /* Task 1 will always run before this task as Task 1 is created with the
  higher priority. Neither Task 1 nor Task 2 ever block so will always be
  in either the Running or the Ready state.

  Query the priority at which this task is running - passing in NULL means
  "return the calling task's priority". */
  uxPriority = uxTaskPriorityGet( NULL );

  for( ;; )
  {
    /* For this task to reach this point Task 1 must have already run and
    set the priority of this task higher than its own.

    Print out the name of this task. */
    vPrintString( "Task 2 is running\r\n" );

    /* Set the priority of this task back down to its original value.
    Passing in NULL as the task handle means "change the priority of the
    calling task". Setting the priority below that of Task 1 will cause
    Task 1 to immediately start running again - pre-empting this task. */
    vPrintString( "About to lower the Task 2 priority\r\n" );
    vTaskPrioritySet( NULL, ( uxPriority - 2 ) );
  }
}

```

Listing 34. The implementation of Task 2 in Example 8

Each task can both query and set its own priority without the use of a valid task handle, by simply using NULL, instead. A task handle is required only when a task wishes to reference a task other than itself, such as when Task 1 changes the priority of Task 2. To allow Task 1 to do this, the Task 2 handle is obtained and saved when Task 2 is created, as highlighted in the comments in Listing 35.

```
/* Declare a variable that is used to hold the handle of Task 2. */
TaskHandle_t xTask2Handle = NULL;

int main( void )
{
    /* Create the first task at priority 2. The task parameter is not used
    and set to NULL. The task handle is also not used so is also set to NULL. */
    xTaskCreate( vTask1, "Task 1", 1000, NULL, 2, NULL );
    /* The task is created at priority 2 _____ ^. */

    /* Create the second task at priority 1 - which is lower than the priority
    given to Task 1. Again the task parameter is not used so is set to NULL -
    BUT this time the task handle is required so the address of xTask2Handle
    is passed in the last parameter. */
    xTaskCreate( vTask2, "Task 2", 1000, NULL, 1, &xTask2Handle );
    /* The task handle is the last parameter _____ ^^^^^^^^^^^^^^^ */

    /* Start the scheduler so the tasks start executing. */
    vTaskStartScheduler();

    /* If all is well then main() will never reach here as the scheduler will
    now be running the tasks. If main() does reach here then it is likely there
    was insufficient heap memory available for the idle task to be created.
    Chapter 2 provides more information on heap memory management. */
    for( ;; );
}
```

Listing 35. The implementation of main() for Example 8

Figure 22 demonstrates the sequence in which the Example 8 tasks execute, with the resultant output shown in Figure 23.

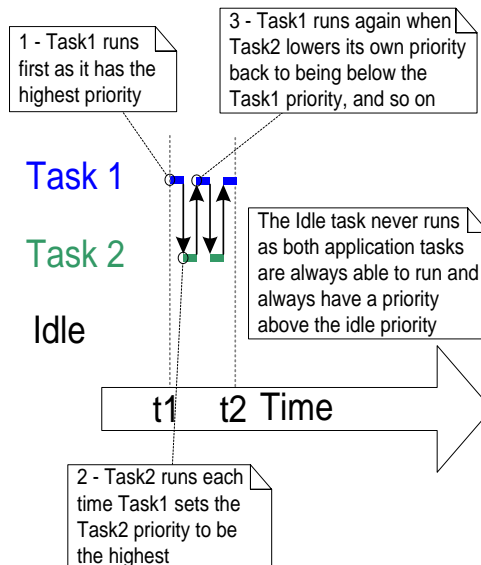

Figure 22. The sequence of task execution when running Example 8

```
C:\Windows\system32\cmd.exe
About to raise the Task2 priority
Task2 is running
About to lower the Task2 priority
Task1 is running
About to raise the Task2 priority
Task2 is running
About to lower the Task2 priority
Task1 is running
About to raise the Task2 priority
Task2 is running
About to lower the Task2 priority
Task1 is running
About to raise the Task2 priority
Task2 is running
About to lower the Task2 priority
Task1 is running
About to raise the Task2 priority
Task2 is running
About to lower the Task2 priority
Task1 is running
About to raise the Task2 priority
```

Figure 23. The output produced when Example 8 is executed

3.10 Deleting a Task

The vTaskDelete() API Function

A task can use the vTaskDelete() API function to delete itself, or any other task. Note that the vTaskDelete() API function is available only when INCLUDE_vTaskDelete is set to 1 in FreeRTOSConfig.h.

Deleted tasks no longer exist and cannot enter the Running state again.

It is the responsibility of the idle task to free memory allocated to tasks that have since been deleted. Therefore, it is important that applications using the vTaskDelete() API function do not completely starve the idle task of all processing time.

Note: Only memory allocated to a task by the kernel itself will be freed automatically when the task is deleted. Any memory or other resource that the implementation of the task allocated must be freed explicitly.

```
void vTaskDelete( TaskHandle_t pxTaskToDelete );
```

Listing 36. The vTaskDelete() API function prototype

Table 13. vTaskDelete() parameters

Parameter Name/ Return Value	Description
pxTaskToDelete	The handle of the task that is to be deleted (the subject task)—see the pxCreatedTask parameter of the xTaskCreate() API function for information on obtaining handles to tasks.

A task can delete itself by passing NULL in place of a valid task handle.

Example 9. Deleting tasks

This is a very simple example that behaves as follows.

1. Task 1 is created by main() with priority 1. When it runs, it creates Task 2 at priority 2. Task 2 is now the highest priority task, so it starts to execute immediately. The source for main() is shown in Listing 37, and the source for Task 1 is shown in Listing 38.
2. Task 2 does nothing other than delete itself. It could delete itself by passing NULL to vTaskDelete() but instead, for demonstration purposes, it uses its own task handle. The source for Task 2 is shown in Listing 39.
3. When Task 2 has been deleted, Task 1 is again the highest priority task, so continues executing—at which point it calls vTaskDelay() to block for a short period.
4. The Idle task executes while Task 1 is in the blocked state and frees the memory that was allocated to the now deleted Task 2.
5. When Task 1 leaves the blocked state it again becomes the highest priority Ready state task and so pre-empts the Idle task. When it enters the Running state it creates Task 2 again, and so it goes on.

```
int main( void )
{
    /* Create the first task at priority 1. The task parameter is not used
    so is set to NULL. The task handle is also not used so likewise is set
    to NULL. */
    xTaskCreate( vTask1, "Task 1", 1000, NULL, 1, NULL );
    /* The task is created at priority 1 _____ ^. */

    /* Start the scheduler so the task starts executing. */
    vTaskStartScheduler();

    /* main() should never reach here as the scheduler has been started. */
    for( ;; );
}
```

Listing 37. The implementation of main() for Example 9

```
TaskHandle_t xTask2Handle = NULL;

void vTask1( void *pvParameters )
{
    const TickType_t xDelay100ms = pdMS_TO_TICKS( 100UL );

    for( ;; )
    {
        /* Print out the name of this task. */
        vPrintString( "Task 1 is running\r\n" );

        /* Create task 2 at a higher priority. Again the task parameter is not
        used so is set to NULL - BUT this time the task handle is required so
        the address of xTask2Handle is passed as the last parameter. */
        xTaskCreate( vTask2, "Task 2", 1000, NULL, 2, &xTask2Handle );
        /* The task handle is the last parameter _____^^^^^^^^^^^^^^^^ */

        /* Task 2 has/had the higher priority, so for Task 1 to reach here Task 2
        must have already executed and deleted itself. Delay for 100
        milliseconds. */
        vTaskDelay( xDelay100ms );
    }
}
```

Listing 38. The implementation of Task 1 for Example 9

```
void vTask2( void *pvParameters )
{
    /* Task 2 does nothing but delete itself. To do this it could call vTaskDelete()
    using NULL as the parameter, but instead, and purely for demonstration purposes,
    it calls vTaskDelete() passing its own task handle. */
    vPrintString( "Task 2 is running and about to delete itself\r\n" );
    vTaskDelete( xTask2Handle );
}
```

Listing 39. The implementation of Task 2 for Example 9

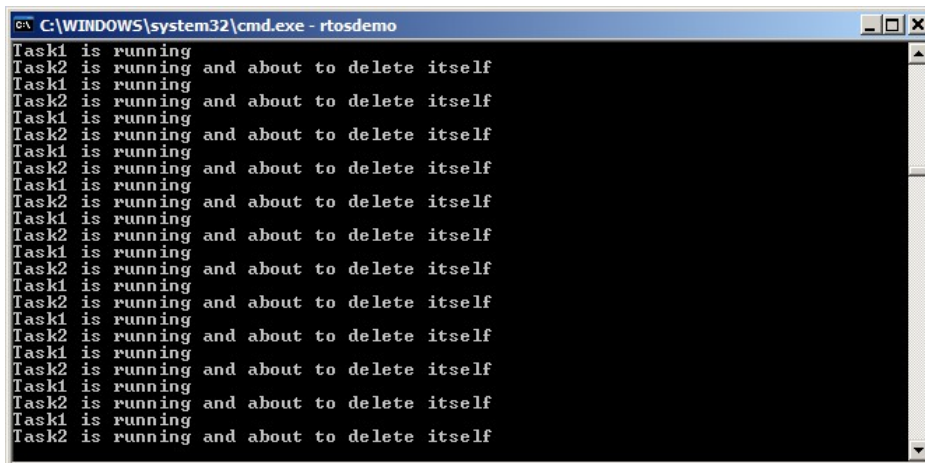

Figure 24. The output produced when Example 9 is executed

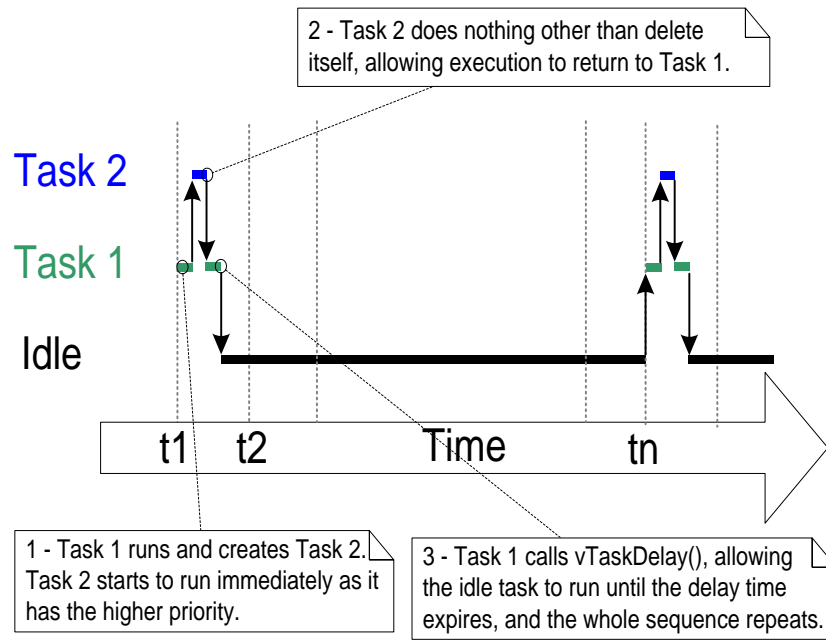

Figure 25. The execution sequence for example 9

3.11 Thread Local Storage

TBD. This section will be written prior to final publication.

3.12 Scheduling Algorithms

A Recap of Task States and Events

The task that is actually running (using processing time) is in the Running state. On a single core processor there can only be one task in the Running state at any given time.

Tasks that are not actually running, but are not in either the Blocked state or the Suspended state, are in the Ready state. Tasks that are in the Ready state are available to be selected by the scheduler as the task to enter the Running state. The scheduler will always choose the highest priority Ready state task to enter the Running state.

Tasks can wait in the Blocked state for an event and are automatically moved back to the Ready state when the event occurs. Temporal events occur at a particular time, for example, when a block time expires, and are normally used to implement periodic or timeout behavior. Synchronization events occur when a task or interrupt service routine sends information using a task notification, queue, event group, or one of the many types of semaphore. They are generally used to signal asynchronous activity, such as data arriving at a peripheral.

Configuring the Scheduling Algorithm

The scheduling algorithm is the software routine that decides which Ready state task to transition into the Running state.

All the examples so far have used the same scheduling algorithm, but the algorithm can be changed using the `configUSE_PREEMPTION` and `configUSE_TIME_SLICING` configuration constants. Both constants are defined in `FreeRTOSConfig.h`.

A third configuration constant, `configUSE_TICKLESS_IDLE`, also affects the scheduling algorithm, as its use can result in the tick interrupt being turned off completely for extended periods. `configUSE_TICKLESS_IDLE` is an advanced option provided specifically for use in applications that must minimize their power consumption. `configUSE_TICKLESS_IDLE` is described in Chapter 10, Low Power Support. The descriptions provided in this section assume `configUSE_TICKLESS_IDLE` is set to 0, which is the default setting if the constant is left undefined.

In all possible configurations the FreeRTOS scheduler will ensure tasks that share a priority are selected to enter the Running state in turn. This ‘take it in turn’ policy is often referred to

as 'Round Robin Scheduling'. A Round Robin scheduling algorithm does not guarantee time is shared equally between tasks of equal priority, only that Ready state tasks of equal priority will enter the Running state in turn.

Prioritized Pre-emptive Scheduling with Time Slicing

The configuration shown in Table 14 sets the FreeRTOS scheduler to use a scheduling algorithm called 'Fixed Priority Pre-emptive Scheduling with Time Slicing', which is the scheduling algorithm used by most small RTOS applications, and the algorithm used by all the examples presented in this book so far. A description of the terminology used in the algorithm's name is provided in Table 15.

Table 14. The FreeRTOSConfig.h settings that configure the kernel to use Prioritized Pre-emptive Scheduling with Time Slicing

Constant	Value
<code>configUSE_PREEMPTION</code>	1
<code>configUSE_TIME_SLICING</code>	1

Table 15. An explanation of the terms used to describe the scheduling policy

Term	Definition
Fixed Priority	Scheduling algorithms described as ‘Fixed Priority’ do not change the priority assigned to the tasks being scheduled, but also do not prevent the tasks themselves from changing their own priority, or that of other tasks.
Pre-emptive	Pre-emptive scheduling algorithms will immediately ‘pre-empt’ the Running state task if a task that has a priority higher than the Running state task enters the Ready state. Being pre-empted means being involuntarily (without explicitly yielding or blocking) moved out of the Running state and into the Ready state to allow a different task to enter the Running state.
Time Slicing	Time slicing is used to share processing time between tasks of equal priority, even when the tasks do not explicitly yield or enter the Blocked state. Scheduling algorithms described as using ‘Time Slicing’ will select a new task to enter the Running state at the end of each time slice if there are other Ready state tasks that have the same priority as the Running task. A time slice is equal to the time between two RTOS tick interrupts.

Figure 26 and Figure 27 demonstrate how tasks are scheduled when a fixed priority preemptive scheduling with time slicing algorithm is used. Figure 26 shows the sequence in which tasks are selected to enter the Running state when all the tasks in an application have a unique priority. Figure 27 shows the sequence in which tasks are selected to enter the Running state when two tasks in an application share a priority.

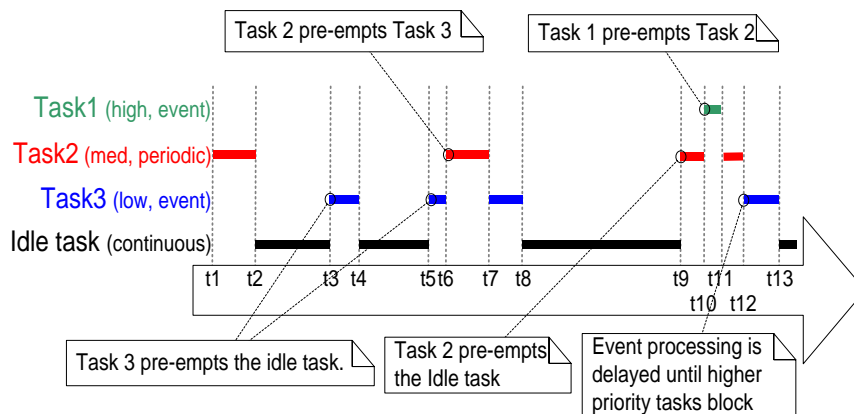

Figure 26. Execution pattern highlighting task prioritization and pre-emption in a hypothetical application in which each task has been assigned a unique priority

Referring to Figure 26:

1. Idle Task

The idle task is running at the lowest priority, so gets pre-empted every time a higher priority task enters the Ready state—for example, at times t3, t5 and t9.

2. Task 3

Task 3 is an event-driven task that executes with a relatively low priority, but above the Idle priority. It spends most of its time in the Blocked state waiting for its event of interest, transitioning from the Blocked state to the Ready state each time the event occurs. All FreeRTOS inter-task communication mechanisms (task notifications, queues, semaphores, event groups, etc.) can be used to signal events and unblock tasks in this way.

Events occur at times t3 and t5, and also somewhere between t9 and t12. The events occurring at times t3 and t5 are processed immediately as, at these times, Task 3 is the highest priority task that is able to run. The event that occurs somewhere between times t9 and t12 is not processed until t12 because, until then, the higher priority tasks Task 1 and Task 2 are still executing. It is only at time t12 that both Task 1 and Task 2 are in the Blocked state, making Task 3 the highest priority Ready state task.

3. Task 2

Task 2 is a periodic task that executes at a priority above the priority of Task 3, but below the priority of Task 1. The task's period interval means Task 2 wants to execute at times t1, t6, and t9.

At time t6, Task 3 is in the Running state, but Task 2 has the higher relative priority so pre-empts Task 3 and starts executing immediately. Task 2 completes its processing and re-enters the Blocked state at time t7, at which point Task 3 can re-enter the Running state to complete its processing. Task 3 itself Blocks at time t8.

4. Task 1

Task 1 is also an event-driven task. It executes with the highest priority of all, so can pre-empt any other task in the system. The only Task 1 event shown occurs at time t10, at which time Task 1 pre-empts Task 2. Task 2 can complete its processing only after Task 1 has re-entered the Blocked state at time t11.

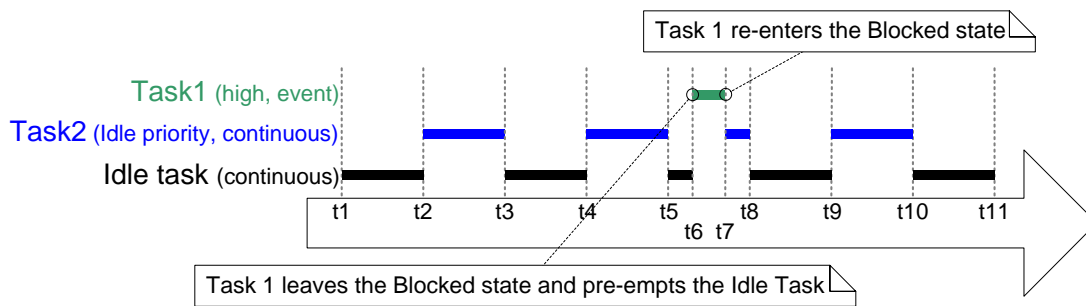

Figure 27 Execution pattern highlighting task prioritization and time slicing in a hypothetical application in which two tasks run at the same priority

Referring to Figure 27:

1. The Idle Task and Task 2

The Idle task and Task 2 are both continuous processing tasks, and both have a priority of 0 (the lowest possible priority). The scheduler only allocates processing time to the priority 0 tasks when there are no higher priority tasks that are able to run, and shares the time that is allocated to the priority 0 tasks by time slicing. A new time slice starts on each tick interrupt, which in Figure 27 is at times t1, t2, t3, t4, t5, t8, t9, t10 and t11.

The Idle task and Task 2 enter the Running state in turn, which can result in both tasks being in the Running state for part of the same time slice, as happens between time t5 and time t8.

2. Task 1

The priority of Task 1 is higher than the Idle priority. Task 1 is an event driven task that spends most of its time in the Blocked state waiting for its event of interest, transitioning from the Blocked state to the Ready state each time the event occurs.

The event of interest occurs at time t6, so at t6 Task 1 becomes the highest priority task that is able to run, and therefore Task 1 pre-empts the Idle task part way through a time slice. Processing of the event completes at time t7, at which point Task 1 re-enters the Blocked state.

Figure 27 shows the Idle task sharing processing time with a task created by the application writer. Allocating that much processing time to the Idle task might not be desirable if the Idle

priority tasks created by the application writer have work to do, but the Idle task does not. The configIDLE_SHOULD_YIELD compile time configuration constant can be used to change how the Idle task is scheduled:

- If configIDLE_SHOULD_YIELD is set to 0 then the Idle task will remain in the Running state for the entirety of its time slice, unless it is preempted by a higher priority task.
- If configIDLE_SHOULD_YIELD is set to 1 then the Idle task will yield (voluntarily give up whatever remains of its allocated time slice) on each iteration of its loop if there are other Idle priority tasks in the Ready state.

The execution pattern shown in Figure 27 is what would be observed when configIDLE_SHOULD_YIELD is set to 0. The execution pattern shown in Figure 28 is what would be observed in the same scenario when configIDLE_SHOULD_YIELD is set to 1.

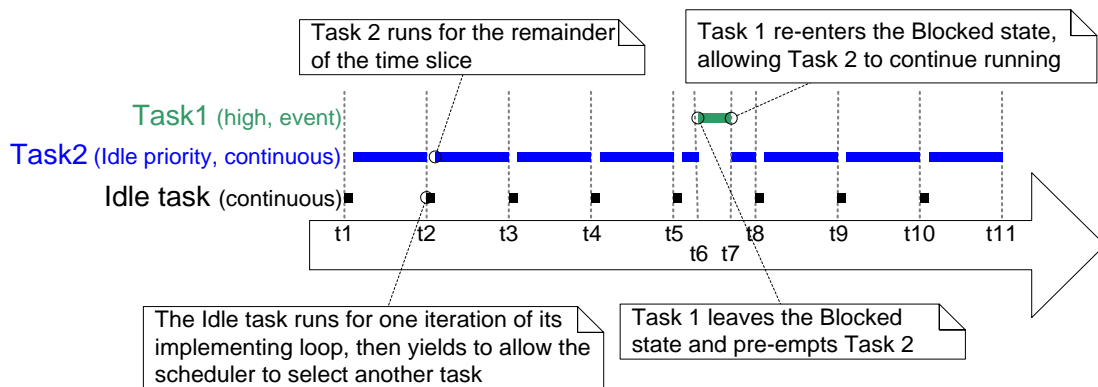

Figure 28 The execution pattern for the same scenario as shown in Figure 27, but this time with configIDLE_SHOULD_YIELD set to 1

Figure 28 also shows that, when configIDLE_SHOULD_YIELD is set to 1, the task selected to enter the Running state after the Idle task does not execute for an entire time slice, but instead executes for whatever remains of the time slice during which the Idle task yielded.

Prioritized Pre-emptive Scheduling (without Time Slicing)

Prioritized Preemptive Scheduling without time slicing maintains the same task selection and pre-emption algorithms as described in the previous section, but does not use time slicing to share processing time between tasks of equal priority.

The FreeRTOSConfig.h settings that configure the FreeRTOS scheduler to use prioritized preemptive scheduling without time slicing are shown in Table 16.

Table 16. The FreeRTOSConfig.h settings that configure the kernel to use Prioritized Pre-emptive Scheduling without Time Slicing

Constant	Value
configUSE_PREEMPTION	1
configUSE_TIME_SLICING	0

As was demonstrated in Figure 27, if time slicing is used, and there is more than one ready state task at the highest priority that is able to run, then the scheduler will select a new task to enter the Running state during each RTOS tick interrupt (a tick interrupt marking the end of a time slice). If time slicing is not used, then the scheduler will only select a new task to enter the Running state when either:

- A higher priority task enters the Ready state.
- The task in the Running state enters the Blocked or Suspended state.

There are fewer task context switches when time slicing is not used than when time slicing is used. Therefore, turning time slicing off results in a reduction in the scheduler's processing overhead. However, turning time slicing off can also result in tasks of equal priority receiving greatly different amounts of processing time, a scenario demonstrated by Figure 29. For this reason, running the scheduler without time slicing is considered an advanced technique that should only be used by experienced users.

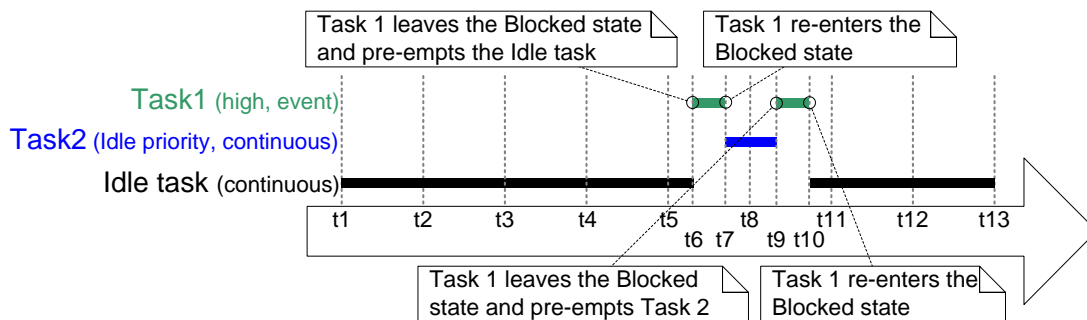

Figure 29 Execution pattern that demonstrates how tasks of equal priority can receive hugely different amounts of processing time when time slicing is not used

Referring to Figure 29, which assumes configIDLE_SHOULD_YIELD is set to 0:

1. Tick Interrupts

Tick interrupts occur at times t1, t2, t3, t4, t5, t8, t11, t12 and t13.

2. Task 1

Task 1 is a high priority event driven task that spends most of its time in the Blocked state waiting for its event of interest. Task 1 transitions from the Blocked state to the Ready state (and subsequently, as it is the highest priority Ready state task, on into the Running state) each time the event occurs. Figure 29 shows Task 1 processing an event between times t6 and t7, then again between times t9 and t10.

3. The Idle Task and Task 2

The Idle task and Task 2 are both continuous processing tasks, and both have a priority of 0 (the idle priority). Continuous processing tasks do not enter the Blocked state.

Time slicing is not being used, so an idle priority task that is in the Running state will remain in the Running state until it is pre-empted by the higher priority Task 1.

In Figure 29 the Idle task starts running at time t1, and remains in the Running state until it is pre-empted by Task 1 at time t6—which is more than four complete tick periods after it entered the Running state.

Task 2 starts running at time t7, which is when Task 1 re-enters the Blocked state to wait for another event. Task 2 remains in the Running state until it too is pre-empted by Task 1 at time t9—which is less than one tick period after it entered the Running state.

At time t10 the Idle task re-enters the Running state, despite having already received more than four times more processing time than the Task 2.

Co-operative Scheduling

This book focuses on pre-emptive scheduling, but FreeRTOS can also use co-operative scheduling. The FreeRTOSConfig.h settings that configure the FreeRTOS scheduler to use co-operative scheduling are shown in Table 17.

Table 17. The FreeRTOSConfig.h settings that configure the kernel to use co-operative scheduling

Constant	Value
configUSE_PREEMPTION	0
configUSE_TIME_SLICING	Any value

When the co-operative scheduler is used, a context switch will only occur when the Running state task enters the Blocked state, or the Running state task explicitly yields (manually requests a re-schedule) by calling `taskYIELD()`. Tasks are never pre-empted, so time slicing cannot be used.

Figure 30 demonstrates the behavior of the co-operative scheduler. The horizontal dashed lines in Figure 30 show when a task is in the Ready state.

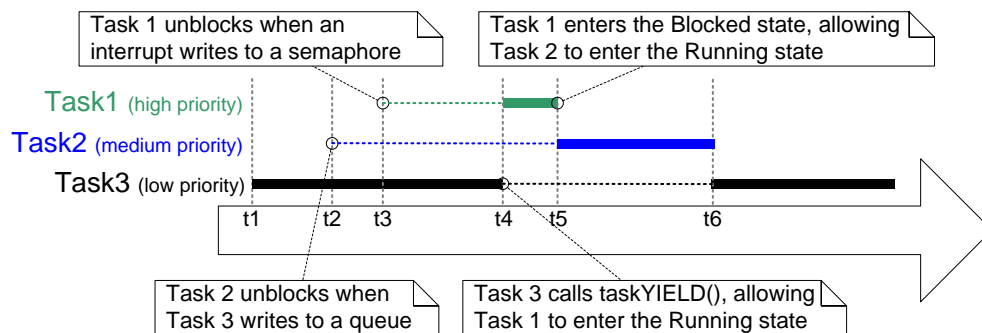

Figure 30 Execution pattern demonstrating the behavior of the co-operative scheduler

Referring to Figure 30:

1. Task 1

Task 1 has the highest priority. It starts in the Blocked state, waiting for a semaphore.

At time t3 an interrupt gives the semaphore, causing Task 1 to leave the Blocked state and enter the Ready state (giving semaphores from interrupts is covered in Chapter 6).

At time t3 Task 1 is the highest priority Ready state task, and if the pre-emptive scheduler had been used Task 1 would become the Running state task. However, as

the co-operative scheduler is being used, Task 1 remains in the Ready state until time t4—which is when the Running state task calls taskYIELD().

2. Task 2

The priority of Task 2 is between that of Task 1 and Task 3. It starts in the Blocked state, waiting for a message that is sent to it by Task 3 at time t2.

At time t2 Task 2 is the highest priority Ready state task, and if the pre-emptive scheduler had been used Task 2 would become the Running state task. However, as the co-operative scheduler is being used, Task 2 remains in the Ready state until the Running state task either enters the Blocked state or calls taskYIELD().

The running state task calls taskYIELD() at time t4, but by then Task 1 is the highest priority Ready state task, so Task 2 does not actually become the Running state task until Task 1 re-enters the Blocked state at time t5.

At time t6 Task 2 re-enters the Blocked state to wait for the next message, at which point Task 3 is once again the highest priority Ready state task.

In a multi-tasking application the application writer must take care that a resource is not accessed by more than one task simultaneously, as simultaneous access could corrupt the resource. As an example, consider the following scenario in which the resource being accessed is a UART (serial port). Two tasks are writing strings to the UART; Task 1 is writing “abcdefghijklmnop”, and Task 2 is writing “123456789”:

1. Task 1 is in the Running state and starts to write its string. It writes “abcdefg” to the UART, but leaves the Running state before writing any further characters.
2. Task 2 enters the Running state and writes “123456789” to the UART, before leaving the Running state.
3. Task 1 re-enters the Running state and writes the remaining characters of its string to the UART.

In that scenario what is actually written to the UART is “abcdefg123456789hijklmnop”. The string written by Task 1 has not been written to the UART in an unbroken sequence as intended, but instead it has been corrupted, because the string written to the UART by Task 2 appears within it.

It is normally easier to avoid problems caused by simultaneous access when the co-operative scheduler is used than when the pre-emptive scheduler is used¹:

- When the pre-emptive scheduler is used the Running state task can be pre-empted at any time, including when a resource it is sharing with another task is in an inconsistent state. As just demonstrated by the UART example, leaving a resource in an inconsistent state can result in data corruption.
- When the co-operative scheduler is used the application writer controls when a switch to another task can occur. The application writer can therefore ensure a switch to another task does not occur while a resource is in an inconsistent state.
- In the above UART example, the application writer can ensure Task 1 does not leave the Running state until its entire string has been written to the UART, and in doing so, removing the possibility of the string being corrupted by the activities of another task.

As demonstrated in Figure 30, systems will be less responsive when the co-operative scheduler is used than when the pre-emptive scheduler is used:

- When the pre-emptive scheduler is used the scheduler will start running a task immediately that the task becomes the highest priority Ready state task. This is often essential in real-time systems that must respond to high priority events within a defined time period.
- When the co-operative scheduler is used a switch to a task that has become the highest priority Ready state task is not performed until the Running state task enters the Blocked state or calls `taskYIELD()`.

¹ Methods of safely sharing resources between tasks are covered later in this book. Resources provided by FreeRTOS itself, such as queues and semaphores, are always safe to share between tasks.

Chapter 4

Queue Management

4.1 Chapter Introduction and Scope

'Queues' provide a task-to-task, task-to-interrupt, and interrupt-to-task communication mechanism.

Scope

This chapter aims to give readers a good understanding of:

- How to create a queue.
- How a queue manages the data it contains.
- How to send data to a queue.
- How to receive data from a queue.
- What it means to block on a queue.
- How to block on multiple queues.
- How to overwrite data in a queue.
- How to clear a queue.
- The effect of task priorities when writing to and reading from a queue.

Only task-to-task communication is covered in this chapter. Task-to-interrupt and interrupt-to-task communication is covered in Chapter 6.

4.2 Characteristics of a Queue

Data Storage

A queue can hold a finite number of fixed size data items. The maximum number of items a queue can hold is called its 'length'. Both the length and the size of each data item are set when the queue is created.

Queues are normally used as First In First Out (FIFO) buffers, where data is written to the end (tail) of the queue and removed from the front (head) of the queue. Figure 31 demonstrates data being written to and read from a queue that is being used as a FIFO. It is also possible to write to the front of a queue, and to overwrite data that is already at the front of a queue.

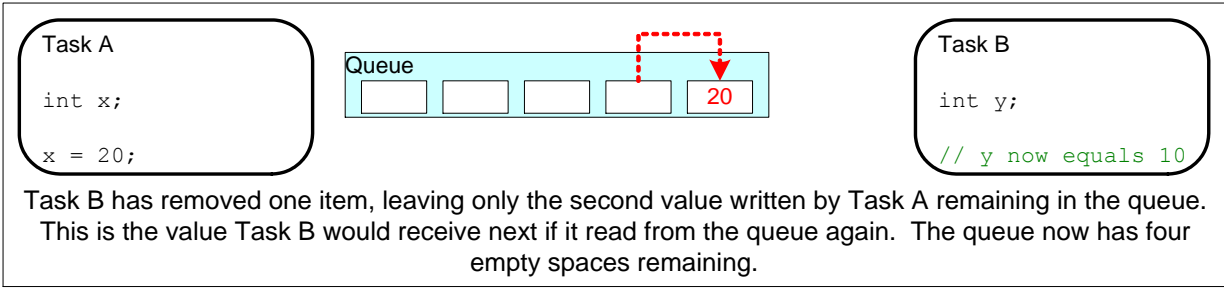
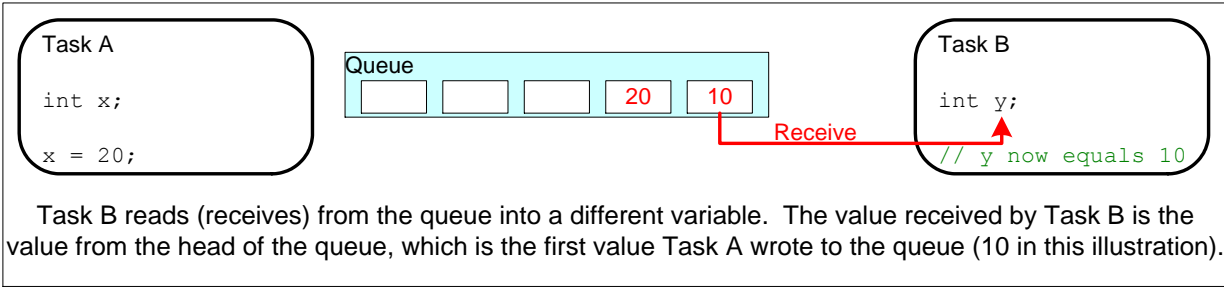
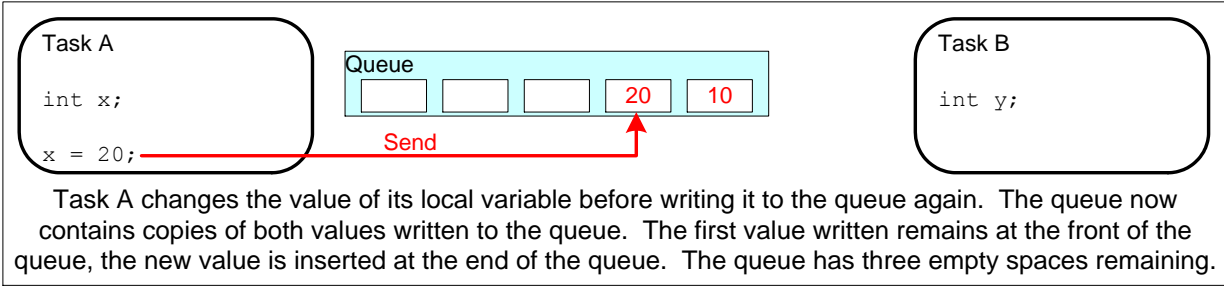
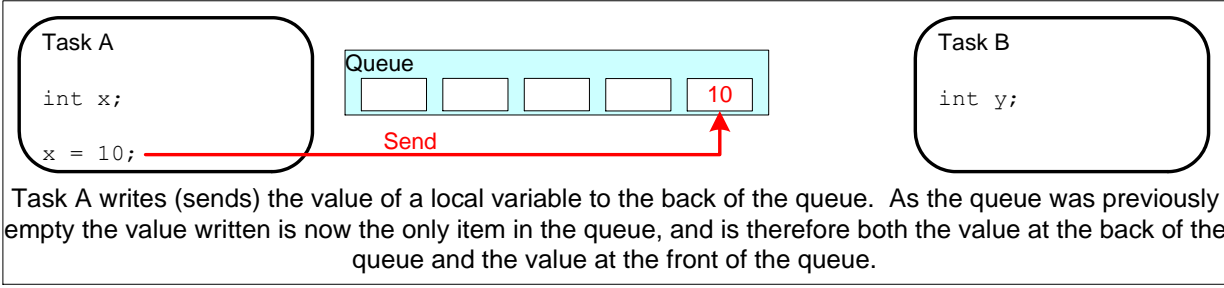
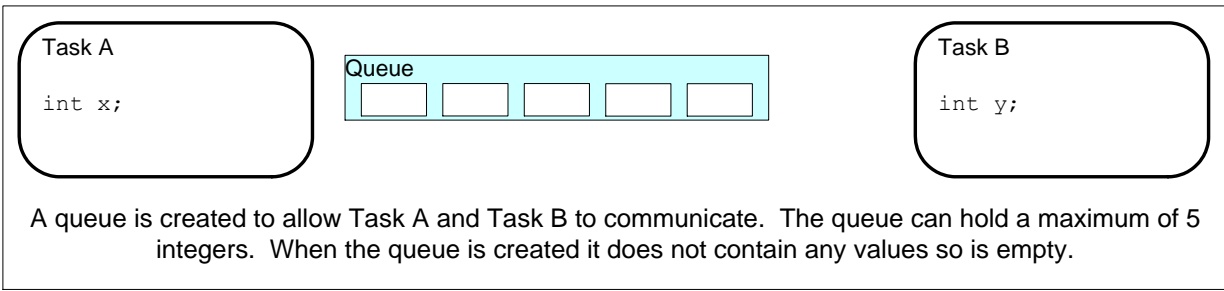

Figure 31. An example sequence of writes to, and reads from a queue

There are two ways in which queue behavior could have been implemented:

1. Queue by copy

Queuing by copy means the data sent to the queue is copied byte for byte into the queue.

2. Queue by reference

Queuing by reference means the queue only holds pointers to the data sent to the queue, not the data itself.

FreeRTOS uses the queue by copy method. Queuing by copy is considered to be simultaneously more powerful and simpler to use than queueing by reference because:

- Stack variable can be sent directly to a queue, even though the variable will not exist after the function in which it is declared has exited.
- Data can be sent to a queue without first allocating a buffer to hold the data, and then copying the data into the allocated buffer.
- The sending task can immediately re-use the variable or buffer that was sent to the queue.
- The sending task and the receiving task are completely de-coupled—the application designer does not need to concern themselves with which task ‘owns’ the data, or which task is responsible for releasing the data.
- Queuing by copy does not prevent the queue from also being used to queue by reference. For example, when the size of the data being queued makes it impractical to copy the data into the queue, then a pointer to the data can be copied into the queue instead.
- The RTOS takes complete responsibility for allocating the memory used to store data.
- In a memory protected system, the RAM that a task can access will be restricted. In that case queueing by reference could only be used if the sending and receiving task could both access the RAM in which the data was stored. Queuing by copy does not impose that restriction; the kernel always runs with full privileges, allowing a queue to be used to pass data across memory protection boundaries.

Access by Multiple Tasks

Queues are objects in their own right that can be accessed by any task or ISR that knows of their existence. Any number of tasks can write to the same queue, and any number of tasks can read from the same queue. In practice it is very common for a queue to have multiple writers, but much less common for a queue to have multiple readers.

Blocking on Queue Reads

When a task attempts to read from a queue, it can optionally specify a 'block' time. This is the time the task will be kept in the Blocked state to wait for data to be available from the queue, should the queue already be empty. A task that is in the Blocked state, waiting for data to become available from a queue, is automatically moved to the Ready state when another task or interrupt places data into the queue. The task will also be moved automatically from the Blocked state to the Ready state if the specified block time expires before data becomes available.

Queues can have multiple readers, so it is possible for a single queue to have more than one task blocked on it waiting for data. When this is the case, only one task will be unblocked when data becomes available. The task that is unblocked will always be the highest priority task that is waiting for data. If the blocked tasks have equal priority, then the task that has been waiting for data the longest will be unblocked.

Blocking on Queue Writes

Just as when reading from a queue, a task can optionally specify a block time when writing to a queue. In this case, the block time is the maximum time the task should be held in the Blocked state to wait for space to become available on the queue, should the queue already be full.

Queues can have multiple writers, so it is possible for a full queue to have more than one task blocked on it waiting to complete a send operation. When this is the case, only one task will be unblocked when space on the queue becomes available. The task that is unblocked will always be the highest priority task that is waiting for space. If the blocked tasks have equal priority, then the task that has been waiting for space the longest will be unblocked.

Blocking on Multiple Queues

Queues can be grouped into sets, allowing a task to enter the Blocked state to wait for data to become available on any of the queues in the set. Queue sets are demonstrated in section 4.6, Receiving From Multiple Queues.

4.3 Using a Queue

The xQueueCreate() API Function

A queue must be explicitly created before it can be used.

Queues are referenced by handles, which are variables of type `QueueHandle_t`. The `xQueueCreate()` API function creates a queue and returns a `QueueHandle_t` that references the queue it created.

FreeRTOS V9.0.0 also includes the `xQueueCreateStatic()` function, which allocates the memory required to create a queue statically at compile time: FreeRTOS allocates RAM from the FreeRTOS heap when a queue is created. The RAM is used to hold both the queue data structures and the items that are contained in the queue. `xQueueCreate()` will return `NULL` if there is insufficient heap RAM available for the queue to be created. Chapter 2 provides more information on the FreeRTOS heap.

```
QueueHandle_t xQueueCreate( UBaseType_t uxQueueLength, UBaseType_t uxItemSize );
```

Listing 40. The `xQueueCreate()` API function prototype

Table 18. `xQueueCreate()` parameters and return value

Parameter Name	Description
<code>uxQueueLength</code>	The maximum number of items that the queue being created can hold at any one time.
<code>uxItemSize</code>	The size in bytes of each data item that can be stored in the queue.
Return Value	If <code>NULL</code> is returned, then the queue cannot be created because there is insufficient heap memory available for FreeRTOS to allocate the queue data structures and storage area. A non- <code>NULL</code> value being returned indicates that the queue has been created successfully. The returned value should be stored as the handle to the created queue.

After a queue has been created the `xQueueReset()` API function can be used to return the queue to its original empty state.

The xQueueSendToBack() and xQueueSendToFront() API Functions

As might be expected, xQueueSendToBack() is used to send data to the back (tail) of a queue, and xQueueSendToFront() is used to send data to the front (head) of a queue.

xQueueSend() is equivalent to, and exactly the same as, xQueueSendToBack().

Note: Never call xQueueSendToFront() or xQueueSendToBack() from an interrupt service routine. The interrupt-safe versions xQueueSendToFrontFromISR() and xQueueSendToBackFromISR() should be used in their place. These are described in Chapter 6.

```
 BaseType_t xQueueSendToFront( QueueHandle_t xQueue,
                             const void * pvItemToQueue,
                             TickType_t xTicksToWait );
```

Listing 41. The xQueueSendToFront() API function prototype

```
 BaseType_t xQueueSendToBack( QueueHandle_t xQueue,
                             const void * pvItemToQueue,
                             TickType_t xTicksToWait );
```

Listing 42. The xQueueSendToBack() API function prototype

Table 19. xQueueSendToFront() and xQueueSendToBack() function parameters and return value

Parameter Name/ Returned Value	Description
xQueue	The handle of the queue to which the data is being sent (written). The queue handle will have been returned from the call to xQueueCreate() used to create the queue.
pvItemToQueue	A pointer to the data to be copied into the queue. The size of each item that the queue can hold is set when the queue is created, so this many bytes will be copied from pvItemToQueue into the queue storage area.

Table 19. xQueueSendToFront() and xQueueSendToBack() function parameters and return value

Parameter Name/ Returned Value	Description
xTicksToWait	<p data-bbox="500 359 1382 489">The maximum amount of time the task should remain in the Blocked state to wait for space to become available on the queue, should the queue already be full.</p> <p data-bbox="500 541 1349 621">Both xQueueSendToFront() and xQueueSendToBack() will return immediately if xTicksToWait is zero and the queue is already full.</p> <p data-bbox="500 674 1333 854">The block time is specified in tick periods, so the absolute time it represents is dependent on the tick frequency. The macro pdMS_TO_TICKS() can be used to convert a time specified in milliseconds into a time specified in ticks.</p> <p data-bbox="500 907 1398 1035">Setting xTicksToWait to portMAX_DELAY will cause the task to wait indefinitely (without timing out), provided INCLUDE_vTaskSuspend is set to 1 in FreeRTOSConfig.h.</p>

Table 19. xQueueSendToFront() and xQueueSendToBack() function parameters and return value

Parameter Name/ Returned Value	Description
Returned value	<p>There are two possible return values:</p> <ol style="list-style-type: none">1. pdPASS <p>pdPASS will be returned only if data was successfully sent to the queue.</p> <p>If a block time was specified (xTicksToWait was not zero), then it is possible the calling task was placed into the Blocked state, to wait for space to become available in the queue, before the function returned, but data was successfully written to the queue before the block time expired.</p> <ol style="list-style-type: none">2. errQUEUE_FULL <p>errQUEUE_FULL will be returned if data could not be written to the queue because the queue was already full.</p> <p>If a block time was specified (xTicksToWait was not zero) then the calling task will have been placed into the Blocked state to wait for another task or interrupt to make space in the queue, but the specified block time expired before that happened.</p>

The xQueueReceive() API Function

xQueueReceive() is used to receive (read) an item from a queue. The item that is received is removed from the queue.

Note: Never call xQueueReceive() from an interrupt service routine. The interrupt-safe xQueueReceiveFromISR() API function is described in Chapter 6.

```

BaseType_t xQueueReceive( QueueHandle_t xQueue,
                          void * const pvBuffer,
                          TickType_t xTicksToWait );

```

Listing 43. The xQueueReceive() API function prototype

Table 20. xQueueReceive() function parameters and return values

Parameter Name/ Returned value	Description
xQueue	<p>The handle of the queue from which the data is being received (read). The queue handle will have been returned from the call to xQueueCreate() used to create the queue.</p>
pvBuffer	<p>A pointer to the memory into which the received data will be copied.</p> <p>The size of each data item that the queue holds is set when the queue is created. The memory pointed to by pvBuffer must be at least large enough to hold that many bytes.</p>
xTicksToWait	<p>The maximum amount of time the task should remain in the Blocked state to wait for data to become available on the queue, should the queue already be empty.</p> <p>If xTicksToWait is zero, then xQueueReceive() will return immediately if the queue is already empty.</p> <p>The block time is specified in tick periods, so the absolute time it represents is dependent on the tick frequency. The macro pdMS_TO_TICKS() can be used to convert a time specified in milliseconds into a time specified in ticks.</p> <p>Setting xTicksToWait to portMAX_DELAY will cause the task to wait indefinitely (without timing out) provided INCLUDE_vTaskSuspend is set to 1 in FreeRTOSConfig.h.</p>

Table 20. xQueueReceive() function parameters and return values

Parameter Name/ Returned value	Description
Returned value	<p>There are two possible return values:</p> <ol style="list-style-type: none">1. pdPASS <p>pdPASS will be returned only if data was successfully read from the queue.</p> <p>If a block time was specified (xTicksToWait was not zero), then it is possible the calling task was placed into the Blocked state, to wait for data to become available on the queue, but data was successfully read from the queue before the block time expired.</p> 2. errQUEUE_EMPTY <p>errQUEUE_EMPTY will be returned if data cannot be read from the queue because the queue is already empty.</p> <p>If a block time was specified (xTicksToWait was not zero,) then the calling task will have been placed into the Blocked state to wait for another task or interrupt to send data to the queue, but the block time expired before that happened.</p>

The uxQueueMessagesWaiting() API Function

uxQueueMessagesWaiting() is used to query the number of items that are currently in a queue.

Note: Never call uxQueueMessagesWaiting() from an interrupt service routine. The interrupt-safe uxQueueMessagesWaitingFromISR() should be used in its place.

```
UBaseType_t uxQueueMessagesWaiting( QueueHandle_t xQueue );
```

Listing 44. The uxQueueMessagesWaiting() API function prototype

Table 21. uxQueueMessagesWaiting() function parameters and return value

Parameter Name/ Returned Value	Description
xQueue	The handle of the queue being queried. The queue handle will have been returned from the call to xQueueCreate() used to create the queue.
Returned value	The number of items that the queue being queried is currently holding. If zero is returned, then the queue is empty.

Example 10. Blocking when receiving from a queue

This example demonstrates a queue being created, data being sent to the queue from multiple tasks, and data being received from the queue. The queue is created to hold data items of type `int32_t`. The tasks that send to the queue do not specify a block time, whereas the task that receives from the queue does.

The priority of the tasks that send to the queue are lower than the priority of the task that receives from the queue. This means the queue should never contain more than one item because, as soon as data is sent to the queue the receiving task will unblock, pre-empt the sending task, and remove the data—leaving the queue empty once again.

Listing 45 shows the implementation of the task that writes to the queue. Two instances of this task are created, one that writes continuously the value 100 to the queue, and another that writes continuously the value 200 to the same queue. The task parameter is used to pass these values into each task instance.

```
static void vSenderTask( void *pvParameters )
{
int32_t lValueToSend;
BaseType_t xStatus;

    /* Two instances of this task are created so the value that is sent to the
    queue is passed in via the task parameter - this way each instance can use
    a different value. The queue was created to hold values of type int32_t,
    so cast the parameter to the required type. */
    lValueToSend = ( int32_t ) pvParameters;

    /* As per most tasks, this task is implemented within an infinite loop. */
    for( ;; )
    {
        /* Send the value to the queue.

        The first parameter is the queue to which data is being sent. The
        queue was created before the scheduler was started, so before this task
        started to execute.

        The second parameter is the address of the data to be sent, in this case
        the address of lValueToSend.

        The third parameter is the Block time - the time the task should be kept
        in the Blocked state to wait for space to become available on the queue
        should the queue already be full. In this case a block time is not
        specified because the queue should never contain more than one item, and
        therefore never be full. */
        xStatus = xQueueSendToBack( xQueue, &lValueToSend, 0 );

        if( xStatus != pdPASS )
        {
            /* The send operation could not complete because the queue was full -
            this must be an error as the queue should never contain more than
            one item! */
            vPrintString( "Could not send to the queue.\r\n" );
        }
    }
}
```

Listing 45. Implementation of the sending task used in Example 10.

Listing 46 shows the implementation of the task that receives data from the queue. The receiving task specifies a block time of 100 milliseconds, so will enter the Blocked state to wait for data to become available. It will leave the Blocked state when either data is available on the queue, or 100 milliseconds passes without data becoming available. In this example, the 100 milliseconds timeout should never expire, as there are two tasks continuously writing to the queue.

```

static void vReceiverTask( void *pvParameters )
{
    /* Declare the variable that will hold the values received from the queue. */
    int32_t lReceivedValue;
    BaseType_t xStatus;
    const TickType_t xTicksToWait = pdMS_TO_TICKS( 100 );

    /* This task is also defined within an infinite loop. */
    for( ;; )
    {
        /* This call should always find the queue empty because this task will
        immediately remove any data that is written to the queue. */
        if( uxQueueMessagesWaiting( xQueue ) != 0 )
        {
            vPrintString( "Queue should have been empty!\r\n" );
        }

        /* Receive data from the queue.

        The first parameter is the queue from which data is to be received. The
        queue is created before the scheduler is started, and therefore before this
        task runs for the first time.

        The second parameter is the buffer into which the received data will be
        placed. In this case the buffer is simply the address of a variable that
        has the required size to hold the received data.

        The last parameter is the block time - the maximum amount of time that the
        task will remain in the Blocked state to wait for data to be available
        should the queue already be empty. */
        xStatus = xQueueReceive( xQueue, &lReceivedValue, xTicksToWait );

        if( xStatus == pdPASS )
        {
            /* Data was successfully received from the queue, print out the received
            value. */
            vPrintStringAndNumber( "Received = ", lReceivedValue );
        }
        else
        {
            /* Data was not received from the queue even after waiting for 100ms.
            This must be an error as the sending tasks are free running and will be
            continuously writing to the queue. */
            vPrintString( "Could not receive from the queue.\r\n" );
        }
    }
}

```

Listing 46. Implementation of the receiver task for Example 10

Listing 47 contains the definition of the main() function. This simply creates the queue and the three tasks before starting the scheduler. The queue is created to hold a maximum of five int32_t values, even though the priorities of the tasks are set such that the queue will never contain more than one item at a time.

```
/* Declare a variable of type QueueHandle_t. This is used to store the handle
to the queue that is accessed by all three tasks. */
QueueHandle_t xQueue;

int main( void )
{
    /* The queue is created to hold a maximum of 5 values, each of which is
    large enough to hold a variable of type int32_t. */
    xQueue = xQueueCreate( 5, sizeof( int32_t ) );

    if( xQueue != NULL )
    {
        /* Create two instances of the task that will send to the queue. The task
        parameter is used to pass the value that the task will write to the queue,
        so one task will continuously write 100 to the queue while the other task
        will continuously write 200 to the queue. Both tasks are created at
        priority 1. */
        xTaskCreate( vSenderTask, "Sender1", 1000, ( void * ) 100, 1, NULL );
        xTaskCreate( vSenderTask, "Sender2", 1000, ( void * ) 200, 1, NULL );

        /* Create the task that will read from the queue. The task is created with
        priority 2, so above the priority of the sender tasks. */
        xTaskCreate( vReceiverTask, "Receiver", 1000, NULL, 2, NULL );

        /* Start the scheduler so the created tasks start executing. */
        vTaskStartScheduler();
    }
    else
    {
        /* The queue could not be created. */
    }

    /* If all is well then main() will never reach here as the scheduler will
    now be running the tasks. If main() does reach here then it is likely that
    there was insufficient FreeRTOS heap memory available for the idle task to be
    created. Chapter 2 provides more information on heap memory management. */
    for( ;; );
}
}
```

Listing 47. The implementation of main() in Example 10

Both tasks that send to the queue have an identical priority. This causes the two sending tasks to send data to the queue in turn. The output produced by Example 10 is shown in Figure 32.

4.4 Receiving Data From Multiple Sources

It is common in FreeRTOS designs for a task to receive data from more than one source. The receiving task needs to know where the data came from to determine how the data should be processed. An easy design solution is to use a single queue to transfer structures with both the value of the data and the source of the data contained in the structure's fields. This scheme is demonstrated in Figure 34.

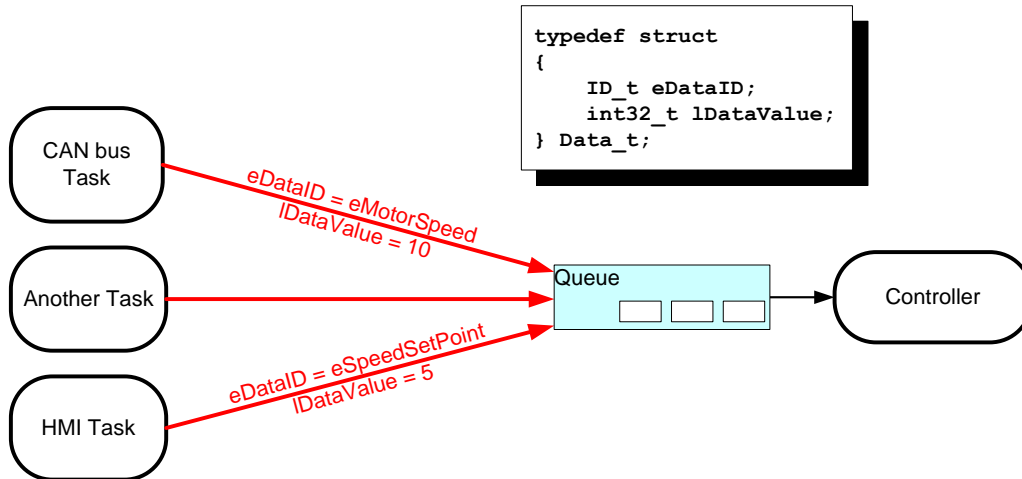

Figure 34. An example scenario where structures are sent on a queue

Referring to Figure 34:

- A queue is created that holds structures of type `Data_t`. The structure members allow both a data value and an enumerated type indicating what the data means to be sent to the queue in one message.
- A central Controller task is used to perform the primary system function. This has to react to inputs and changes to the system state communicated to it on the queue.
- A CAN bus task is used to encapsulate the CAN bus interfacing functionality. When the CAN bus task has received and decoded a message, it sends the already decoded message to the Controller task in a `Data_t` structure. The `eDataID` member of the transferred structure is used to let the Controller task know what the data is—in the depicted case it is a motor speed value. The `IDataValue` member of the transferred structure is used to let the Controller task know the actual motor speed value.
- A Human Machine Interface (HMI) task is used to encapsulate all the HMI functionality. The machine operator can probably input commands and query values in a number of

ways that have to be detected and interpreted within the HMI task. When a new command is input, the HMI task sends the command to the Controller task in a `Data_t` structure. The `eDataID` member of the transferred structure is used to let the Controller task know what the data is—in the depicted case it is a new set point value. The `IDataValue` member of the transferred structure is used to let the Controller task know the actual set point value.

Example 11. Blocking when sending to a queue, and sending structures on a queue

Example 11 is similar to Example 10, but the task priorities are reversed, so the receiving task has a lower priority than the sending tasks. Also, the queue is used to pass structures, rather than integers.

Listing 48 shows the definition of the structure used by Example 11.

```
/* Define an enumerated type used to identify the source of the data. */
typedef enum
{
    eSender1,
    eSender2
} DataSource_t;

/* Define the structure type that will be passed on the queue. */
typedef struct
{
    uint8_t ucValue;
    DataSource_t eDataSource;
} Data_t;

/* Declare two variables of type Data_t that will be passed on the queue. */
static const Data_t xStructsToSend[ 2 ] =
{
    { 100, eSender1 }, /* Used by Sender1. */
    { 200, eSender2 } /* Used by Sender2. */
};
```

Listing 48. The definition of the structure that is to be passed on a queue, plus the declaration of two variables for use by the example

In Example 10, the receiving task has the highest priority, so the queue never contains more than one item. This results from the receiving task pre-empting the sending tasks as soon as data is placed into the queue. In Example 11, the sending tasks have the higher priority, so the queue will normally be full. This is because, as soon as the receiving task removes an item from the queue, it is pre-empted by one of the sending tasks which then immediately re-fills the queue. The sending task then re-enters the Blocked state to wait for space to become available on the queue again.

Listing 49 shows the implementation of the sending task. The sending task specifies a block time of 100 milliseconds, so it enters the Blocked state to wait for space to become available each time the queue becomes full. It leaves the Blocked state when either space is available on the queue, or 100 milliseconds passes without space becoming available. In this example, the 100 milliseconds timeout should never expire, as the receiving task is continuously making space by removing items from the queue.

```
static void vSenderTask( void *pvParameters )
{
    BaseType_t xStatus;
    const TickType_t xTicksToWait = pdMS_TO_TICKS( 100 );

    /* As per most tasks, this task is implemented within an infinite loop. */
    for( ;; )
    {
        /* Send to the queue.

        The second parameter is the address of the structure being sent. The
        address is passed in as the task parameter so pvParameters is used
        directly.

        The third parameter is the Block time - the time the task should be kept
        in the Blocked state to wait for space to become available on the queue
        if the queue is already full. A block time is specified because the
        sending tasks have a higher priority than the receiving task so the queue
        is expected to become full. The receiving task will remove items from
        the queue when both sending tasks are in the Blocked state. */
        xStatus = xQueueSendToBack( xQueue, pvParameters, xTicksToWait );

        if( xStatus != pdPASS )
        {
            /* The send operation could not complete, even after waiting for 100ms.
            This must be an error as the receiving task should make space in the
            queue as soon as both sending tasks are in the Blocked state. */
            vPrintString( "Could not send to the queue.\r\n" );
        }
    }
}
```

Listing 49. The implementation of the sending task for Example 11

The receiving task has the lowest priority, so it will run only when both sending tasks are in the Blocked state. The sending tasks will enter the Blocked state only when the queue is full, so the receiving task will execute only when the queue is already full. Therefore, it always expects to receive data even when it does not specify a block time.

The implementation of the receiving task is shown in Listing 50.

```

static void vReceiverTask( void *pvParameters )
{
    /* Declare the structure that will hold the values received from the queue. */
    Data_t xReceivedStructure;
    BaseType_t xStatus;

    /* This task is also defined within an infinite loop. */
    for( ;; )
    {
        /* Because it has the lowest priority this task will only run when the
        sending tasks are in the Blocked state. The sending tasks will only enter
        the Blocked state when the queue is full so this task always expects the
        number of items in the queue to be equal to the queue length, which is 3 in
        this case. */
        if( uxQueueMessagesWaiting( xQueue ) != 3 )
        {
            vPrintString( "Queue should have been full!\r\n" );
        }

        /* Receive from the queue.

        The second parameter is the buffer into which the received data will be
        placed. In this case the buffer is simply the address of a variable that
        has the required size to hold the received structure.

        The last parameter is the block time - the maximum amount of time that the
        task will remain in the Blocked state to wait for data to be available
        if the queue is already empty. In this case a block time is not necessary
        because this task will only run when the queue is full. */
        xStatus = xQueueReceive( xQueue, &xReceivedStructure, 0 );

        if( xStatus == pdPASS )
        {
            /* Data was successfully received from the queue, print out the received
            value and the source of the value. */
            if( xReceivedStructure.eDataSource == eSender1 )
            {
                vPrintStringAndNumber( "From Sender 1 = ", xReceivedStructure.ucValue );
            }
            else
            {
                vPrintStringAndNumber( "From Sender 2 = ", xReceivedStructure.ucValue );
            }
        }
        else
        {
            /* Nothing was received from the queue. This must be an error as this
            task should only run when the queue is full. */
            vPrintString( "Could not receive from the queue.\r\n" );
        }
    }
}

```

Listing 50. The definition of the receiving task for Example 11

main() changes only slightly from the previous example. The queue is created to hold three Data_t structures, and the priorities of the sending and receiving tasks are reversed. The implementation of main() is shown in Listing 51.

Figure 36 demonstrates the sequence of execution that results from having the priority of the sending tasks above the priority of the receiving task. Table 22 provides further explanation of Figure 36, and describes why the first four message originate from the same task.

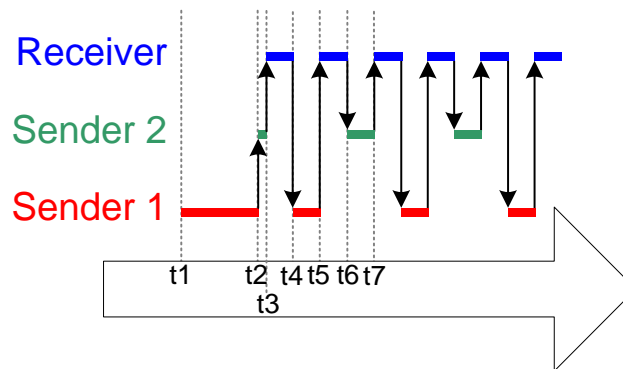

Figure 36. The sequence of execution produced by Example 11

Table 22. Key to Figure 36

Time	Description
t1	Task Sender 1 executes and sends 3 data items to the queue.
t2	The queue is full so Sender 1 enters the Blocked state to wait for its next send to complete. Task Sender 2 is now the highest priority task that is able to run, so enters the Running state.
t3	Task Sender 2 finds the queue is already full, so enters the Blocked state to wait for its first send to complete. Task Receiver is now the highest priority task that is able to run, so enters the Running state.
t4	Two tasks that have a priority higher than the receiving task's priority are waiting for space to become available on the queue, resulting in task Receiver being pre-empted as soon as it has removed one item from the queue. Tasks Sender 1 and Sender 2 have the same priority, so the scheduler selects the task that has been waiting the longest as the task that will enter the Running state—in this case that is task Sender 1.

Table 22. Key to Figure 36

Time	Description
t5	<p>Task Sender 1 sends another data item to the queue. There was only one space in the queue, so task Sender 1 enters the Blocked state to wait for its next send to complete. Task Receiver is again the highest priority task that is able to run so enters the Running state.</p> <p>Task Sender 1 has now sent four items to the queue, and task Sender 2 is still waiting to send its first item to the queue.</p>
t6	<p>Two tasks that have a priority higher than the receiving task's priority are waiting for space to become available on the queue, so task Receiver is pre-empted as soon as it has removed one item from the queue. This time Sender 2 has been waiting longer than Sender 1, so Sender 2 enters the Running state.</p>
t7	<p>Task Sender 2 sends a data item to the queue. There was only one space in the queue so Sender 2 enters the Blocked state to wait for its next send to complete. Both tasks Sender 1 and Sender 2 are waiting for space to become available on the queue, so task Receiver is the only task that can enter the Running state.</p>

4.5 Working with Large or Variable Sized Data

Queuing Pointers

If the size of the data being stored in the queue is large, then it is preferable to use the queue to transfer pointers to the data, rather than copy the data itself into and out of the queue byte by byte. Transferring pointers is more efficient in both processing time and the amount of RAM required to create the queue. However, when queuing pointers, extreme care must be taken to ensure that:

1. The owner of the RAM being pointed to is clearly defined.

When sharing memory between tasks via a pointer, it is essential to ensure that both tasks do not modify the memory contents simultaneously, or take any other action that could cause the memory contents to be invalid or inconsistent. Ideally, only the sending task should be permitted to access the memory until a pointer to the memory has been queued, and only the receiving task should be permitted to access the memory after the pointer has been received from the queue.

2. The RAM being pointed to remains valid.

If the memory being pointed to was allocated dynamically, or obtained from a pool of pre-allocated buffers, then exactly one task should be responsible for freeing the memory. No tasks should attempt to access the memory after it has been freed.

A pointer should never be used to access data that has been allocated on a task stack. The data will not be valid after the stack frame has changed.

By way of example, Listing 52, Listing 53 and Listing 54 demonstrate how to use a queue to send a pointer to a buffer from one task to another:

- Listing 52 creates a queue that can hold up to 5 pointers.
- Listing 53 allocates a buffer, writes a string to the buffer, then sends a pointer to the buffer to the queue.
- Listing 54 receives a pointer to a buffer from the queue, then prints the string contained in the buffer.

```
/* Declare a variable of type QueueHandle_t to hold the handle of the queue being created. */
QueueHandle_t xPointerQueue;

/* Create a queue that can hold a maximum of 5 pointers, in this case character pointers. */
xPointerQueue = xQueueCreate( 5, sizeof( char * ) );
```

Listing 52. Creating a queue that holds pointers

```
/* A task that obtains a buffer, writes a string to the buffer, then sends the address of the
buffer to the queue created in Listing 52. */
void vStringSendingTask( void *pvParameters )
{
    char *pcStringToSend;
    const size_t xMaxStringLength = 50;
    BaseType_t xStringNumber = 0;

    for( ;; )
    {
        /* Obtain a buffer that is at least xMaxStringLength characters big. The implementation
        of prvGetBuffer() is not shown - it might obtain the buffer from a pool of pre-allocated
        buffers, or just allocate the buffer dynamically. */
        pcStringToSend = ( char * ) prvGetBuffer( xMaxStringLength );

        /* Write a string into the buffer. */
        snprintf( pcStringToSend, xMaxStringLength, "String number %d\r\n", xStringNumber );

        /* Increment the counter so the string is different on each iteration of this task. */
        xStringNumber++;

        /* Send the address of the buffer to the queue that was created in Listing 52. The
        address of the buffer is stored in the pcStringToSend variable.*/
        xQueueSend( xPointerQueue, /* The handle of the queue. */
                   &pcStringToSend, /* The address of the pointer that points to the buffer. */
                   portMAX_DELAY );
    }
}
```

Listing 53. Using a queue to send a pointer to a buffer

```
/* A task that receives the address of a buffer from the queue created in Listing 52, and
written to in Listing 53. The buffer contains a string, which is printed out. */
void vStringReceivingTask( void *pvParameters )
{
    char *pcReceivedString;

    for( ;; )
    {
        /* Receive the address of a buffer. */
        xQueueReceive( xPointerQueue, /* The handle of the queue. */
                     &pcReceivedString, /* Store the buffer's address in pcReceivedString. */
                     portMAX_DELAY );

        /* The buffer holds a string, print it out. */
        vPrintString( pcReceivedString );

        /* The buffer is not required any more - release it so it can be freed, or re-used. */
        prvReleaseBuffer( pcReceivedString );
    }
}
```

Listing 54. Using a queue to receive a pointer to a buffer

Using a Queue to Send Different Types and Lengths of Data

Previous sections have demonstrated two powerful design patterns; sending structures to a queue, and sending pointers to a queue. Combining those techniques allows a task to use a single queue to receive any data type from any data source. The implementation of the FreeRTOS+TCP TCP/IP stack provides a practical example of how this is achieved.

The TCP/IP stack, which runs in its own task, must process events from many different sources. Different event types are associated with different types and lengths of data. All events that occur outside of the TCP/IP task are described by a structure of type `IPStackEvent_t`, and sent to the TCP/IP task on a queue. The `IPStackEvent_t` structure is shown in Listing 55. The `pvData` member of the `IPStackEvent_t` structure is a pointer that can be used to hold a value directly, or point to a buffer.

```
/* A subset of the enumerated types used in the TCP/IP stack to identify events. */
typedef enum
{
    eNetworkDownEvent = 0, /* The network interface has been lost, or needs (re)connecting. */
    eNetworkRxEvent,      /* A packet has been received from the network. */
    eTCPAcceptEvent,      /* FreeRTOS_accept() called to accept or wait for a new client. */

    /* Other event types appear here but are not shown in this listing. */
} eIPEvent_t;

/* The structure that describes events, and is sent on a queue to the TCP/IP task. */
typedef struct IP_TASK_COMMANDS
{
    /* An enumerated type that identifies the event. See the eIPEvent_t definition above. */
    eIPEvent_t eEventType;

    /* A generic pointer that can hold a value, or point to a buffer. */
    void *pvData;
} IPStackEvent_t;
```

Listing 55. The structure used to send events to the TCP/IP stack task in FreeRTOS+TCP

Example TCP/IP events, and their associated data, include:

- `eNetworkRxEvent`: A packet of data has been received from the network.

Data received from the network is sent to the TCP/IP task using a structure of type `IPStackEvent_t`. The structure's `eEventType` member is set to `eNetworkRxEvent`, and the structure's `pvData` member is used to point to the buffer that contains the received data. A pseudo code example is shown in Listing 56.

```
void vSendRxDataToTheTCPTask( NetworkBufferDescriptor_t *pRxedData )
{
    IPStackEvent_t xEventStruct;

    /* Complete the IPStackEvent_t structure. The received data is stored in
    pRxedData. */
    xEventStruct.eEventType = eNetworkRxEvent;
    xEventStruct.pvData = ( void * ) pRxedData;

    /* Send the IPStackEvent_t structure to the TCP/IP task. */
    xSendEventStructToIPTask( &xEventStruct );
}
```

Listing 56. Pseudo code showing how an IPStackEvent_t structure is used to send data received from the network to the TCP/IP task

- eTCPAcceptEvent: A socket is to accept, or wait for, a connection from a client.

Accept events are sent from the task that called FreeRTOS_accept() to the TCP/IP task using a structure of type IPStackEvent_t. The structure's eEventType member is set to eTCPAcceptEvent, and the structure's pvData member is set to the handle of the socket that is accepting a connection. A pseudo code example is shown in Listing 57.

```
void vSendAcceptRequestToTheTCPTask( Socket_t xSocket )
{
    IPStackEvent_t xEventStruct;

    /* Complete the IPStackEvent_t structure. */
    xEventStruct.eEventType = eTCPAcceptEvent;
    xEventStruct.pvData = ( void * ) xSocket;

    /* Send the IPStackEvent_t structure to the TCP/IP task. */
    xSendEventStructToIPTask( &xEventStruct );
}
```

Listing 57. Pseudo code showing how an IPStackEvent_t structure is used to send the handle of a socket that is accepting a connection to the TCP/IP task

- eNetworkDownEvent: The network needs connecting, or re-connecting.

Network down events are sent from the network interface to the TCP/IP task using a structure of type IPStackEvent_t. The structure's eEventType member is set to eNetworkDownEvent. Network down events are not associated with any data, so the structure's pvData member is not used. A pseudo code example is shown in Listing 58.

```

void vSendNetworkDownEventToTheTCPTask( Socket_t xSocket )
{
    IPStackEvent_t xEventStruct;

    /* Complete the IPStackEvent_t structure. */
    xEventStruct.eEventType = eNetworkDownEvent;
    xEventStruct.pvData = NULL; /* Not used, but set to NULL for completeness. */

    /* Send the IPStackEvent_t structure to the TCP/IP task. */
    xSendEventStructToIPTask( &xEventStruct );
}

```

Listing 58. Pseudo code showing how an IPStackEvent_t structure is used to send a network down event to the TCP/IP task

The code that receives and processes these events within the TCP/IP task is shown in Listing 59. It can be seen that the eEventType member of the IPStackEvent_t structures received from the queue is used to determine how the pvData member is to be interpreted.

```

IPStackEvent_t xReceivedEvent;

/* Block on the network event queue until either an event is received, or xNextIPSleep ticks
pass without an event being received. eEventType is set to eNoEvent in case the call to
xQueueReceive() returns because it timed out, rather than because an event was received. */
xReceivedEvent.eEventType = eNoEvent;
xQueueReceive( xNetworkEventQueue, &xReceivedEvent, xNextIPSleep );

/* Which event was received, if any? */
switch( xReceivedEvent.eEventType )
{
    case eNetworkDownEvent :
        /* Attempt to (re)establish a connection. This event is not associated with any
        data. */
        prvProcessNetworkDownEvent();
        break;

    case eNetworkRxEvent:
        /* The network interface has received a new packet. A pointer to the received data
        is stored in the pvData member of the received IPStackEvent_t structure. Process
        the received data. */
        prvHandleEthernetPacket( ( NetworkBufferDescriptor_t * )( xReceivedEvent.pvData ) );
        break;

    case eTCPAcceptEvent:
        /* The FreeRTOS_accept() API function was called. The handle of the socket that is
        accepting a connection is stored in the pvData member of the received IPStackEvent_t
        structure. */
        xSocket = ( FreeRTOS_Socket_t * ) ( xReceivedEvent.pvData );
        xTCPCheckNewClient( pxSocket );
        break;

    /* Other event types are processed in the same way, but are not shown here. */
}

```

Listing 59. Pseudo code showing how an IPStackEvent_t structure is received and processed

4.6 Receiving From Multiple Queues

Queue Sets

Often application designs require a single task to receive data of different sizes, data of different meaning, and data from different sources. The previous section demonstrated how this can be achieved in a neat and efficient way using a single queue that receives structures. However, sometimes an application's designer is working with constraints that limit their design choices, necessitating the use of a separate queue for some data sources. For example, third party code being integrated into a design might assume the presence of a dedicated queue. In such cases a 'queue set' can be used.

Queue sets allow a task to receive data from more than one queue without the task polling each queue in turn to determine which, if any, contains data.

A design that uses a queue set to receive data from multiple sources is less neat, and less efficient, than a design that achieves the same functionality using a single queue that receives structures. For that reason, it is recommended that queue sets are only used if design constraints make their use absolutely necessary.

The following sections describe how to use a queue set by:

1. Creating a queue set.
2. Adding queues to the set.

Semaphores can also be added to a queue set. Semaphores are described later in this book.

3. Reading from the queue set to determine which queues within the set contain data.

When a queue that is a member of a set receives data, the handle of the receiving queue is sent to the queue set, and returned when a task calls a function that reads from the queue set. Therefore, if a queue handle is returned from a queue set then the queue referenced by the handle is known to contain data, and the task can then read from the queue directly.

Note: If a queue is a member of a queue set then do not read data from the queue unless the queue's handle has first been read from the queue set.

Queue set functionality is enabled by setting the `configUSE_QUEUE_SETS` compile time configuration constant to 1 in `FreeRTOSConfig.h`.

The `xQueueCreateSet()` API Function

A queue set must be explicitly created before it can be used.

Queues sets are referenced by handles, which are variables of type `QueueSetHandle_t`. The `xQueueCreateSet()` API function creates a queue set and returns a `QueueSetHandle_t` that references the queue set it created.

```
QueueSetHandle_t xQueueCreateSet( const UBaseType_t uxEventQueueLength );
```

Listing 60. The `xQueueCreateSet()` API function prototype

Table 23. xQueueCreateSet() parameters and return value

Parameter Name	Description
uxEventQueueLength	<p>When a queue that is a member of a queue set receives data, the handle of the receiving queue is sent to the queue set. uxEventQueueLength defines the maximum number of queue handles the queue set being created can hold at any one time.</p> <p>Queue handles are only sent to a queue set when a queue within the set receives data. A queue cannot receive data if it is full, so no queue handles can be sent to the queue set if all the queues in the set are full. Therefore, the maximum number of items the queue set will ever have to hold at one time is the sum of the lengths of every queue in the set.</p> <p>As an example, if there are three empty queues in the set, and each queue has a length of five, then in total the queues in the set can receive fifteen items (three queues multiplied by five items each) before all the queues in the set are full. In that example uxEventQueueLength must be set to fifteen to guarantee the queue set can receive every item sent to it.</p> <p>Semaphores can also be added to a queue set. Binary and counting semaphores are covered later in this book. For the purposes of calculating the necessary uxEventQueueLength, the length of a binary semaphore is one, and the length of a counting semaphore is given by the semaphore's maximum count value.</p> <p>As another example, if a queue set will contain a queue that has a length of three, and a binary semaphore (which has a length of one), uxEventQueueLength must be set to four (three plus one).</p>

Table 23. xQueueCreateSet() parameters and return value

Parameter Name	Description
Return Value	<p>If NULL is returned, then the queue set cannot be created because there is insufficient heap memory available for FreeRTOS to allocate the queue set data structures and storage area.</p> <p>A non-NULL value being returned indicates that the queue set has been created successfully. The returned value should be stored as the handle to the created queue set.</p>

The xQueueAddToSet() API Function

xQueueAddToSet() adds a queue or semaphore to a queue set. Semaphores are described later in this book.

```
 BaseType_t xQueueAddToSet( QueueSetMemberHandle_t xQueueOrSemaphore,
                          QueueSetHandle_t xQueueSet );
```

Listing 61. The xQueueAddToSet() API function prototype

Table 24. xQueueAddToSet() parameters and return value

Parameter Name	Description
xQueueOrSemaphore	<p>The handle of the queue or semaphore that is being added to the queue set.</p> <p>Queue handles and semaphore handles can both be cast to the QueueSetMemberHandle_t type.</p>
xQueueSet	<p>The handle of the queue set to which the queue or semaphore is being added.</p>

Table 24. xQueueAddToSet() parameters and return value

Parameter Name	Description
Return Value	<p>There are two possible return values:</p> <ol style="list-style-type: none">1. pdPASS <p>pdPASS will be returned only if the queue or semaphore was successfully added to the queue set.</p> <ol style="list-style-type: none">2. pdFAIL <p>pdFAIL will be returned if the queue or semaphore could not be added to the queue set.</p> <p>Queues and binary semaphores can only be added to a set when they are empty. Counting semaphores can only be added to a set when their count is zero. Queues and semaphores can only be a member of one set at a time.</p>

The xQueueSelectFromSet() API Function

xQueueSelectFromSet() reads a queue handle from the queue set.

When a queue or semaphore that is a member of a set receives data, the handle of the receiving queue or semaphore is sent to the queue set, and returned when a task calls xQueueSelectFromSet(). If a handle is returned from a call to xQueueSelectFromSet() then the queue or semaphore referenced by the handle is known to contain data and the calling task must then read from the queue or semaphore directly.

Note: Do not read data from a queue or semaphore that is a member of a set unless the handle of the queue or semaphore has first been returned from a call to xQueueSelectFromSet(). Only read one item from a queue or semaphore each time the queue handle or semaphore handle is returned from a call to xQueueSelectFromSet().

```
QueueSetMemberHandle_t xQueueSelectFromSet( QueueSetHandle_t xQueueSet,  
                                             const TickType_t xTicksToWait );
```

Listing 62. The xQueueSelectFromSet() API function prototype

Table 25. xQueueSelectFromSet() parameters and return value

Parameter Name	Description
xQueueSet	<p>The handle of the queue set from which a queue handle or semaphore handle is being received (read). The queue set handle will have been returned from the call to xQueueCreateSet() used to create the queue set.</p>
xTicksToWait	<p>The maximum amount of time the calling task should remain in the Blocked state to wait to receive a queue or semaphore handle from the queue set, if all the queues and semaphore in the set are empty.</p> <p>If xTicksToWait is zero then xQueueSelectFromSet() will return immediately if all the queues and semaphores in the set are empty.</p> <p>The block time is specified in tick periods, so the absolute time it represents is dependent on the tick frequency. The macro pdMS_TO_TICKS() can be used to convert a time specified in milliseconds to a time specified in ticks.</p> <p>Setting xTicksToWait to portMAX_DELAY will cause the task to wait indefinitely (without timing out) provided INCLUDE_vTaskSuspend is set to 1 in FreeRTOSConfig.h.</p>

Table 25. xQueueSelectFromSet() parameters and return value

Parameter Name	Description
Return Value	<p>A return value that is not NULL will be the handle of a queue or semaphore that is known to contain data. If a block time was specified (xTicksToWait was not zero), then it is possible that the calling task was placed into the Blocked state to wait for data to become available from a queue or semaphore in the set, but a handle was successfully read from the queue set before the block time expired. Handles are returned as a QueueSetMemberHandle_t type, which can be cast to either a QueueHandle_t type or SemaphoreHandle_t type.</p> <p>If the return value is NULL then a handle could not be read from the queue set. If a block time was specified (xTicksToWait was not zero) then the calling task will have been placed into the Blocked state to wait for another task or interrupt to send data to a queue or semaphore in the set, but the block time expired before that happened.</p>

Example 12. Using a Queue Set

This example creates two sending tasks and one receiving task. The sending tasks send data to the receiving task on two separate queues, one queue for each task. The two queues are added to a queue set, and the receiving task reads from the queue set to determine which of the two queues contain data.

The tasks, queues, and the queue set, are all created in main()—see Listing 63 for its implementation.

```

/* Declare two variables of type QueueHandle_t. Both queues are added to the same
queue set. */
static QueueHandle_t xQueue1 = NULL, xQueue2 = NULL;

/* Declare a variable of type QueueSetHandle_t. This is the queue set to which the
two queues are added. */
static QueueSetHandle_t xQueueSet = NULL;

int main( void )
{
    /* Create the two queues, both of which send character pointers. The priority
of the receiving task is above the priority of the sending tasks, so the queues
will never have more than one item in them at any one time*/
    xQueue1 = xQueueCreate( 1, sizeof( char * ) );
    xQueue2 = xQueueCreate( 1, sizeof( char * ) );

    /* Create the queue set. Two queues will be added to the set, each of which can
contain 1 item, so the maximum number of queue handles the queue set will ever
have to hold at one time is 2 (2 queues multiplied by 1 item per queue). */
    xQueueSet = xQueueCreateSet( 1 * 2 );

    /* Add the two queues to the set. */
    xQueueAddToSet( xQueue1, xQueueSet );
    xQueueAddToSet( xQueue2, xQueueSet );

    /* Create the tasks that send to the queues. */
    xTaskCreate( vSenderTask1, "Sender1", 1000, NULL, 1, NULL );
    xTaskCreate( vSenderTask2, "Sender2", 1000, NULL, 1, NULL );

    /* Create the task that reads from the queue set to determine which of the two
queues contain data. */
    xTaskCreate( vReceiverTask, "Receiver", 1000, NULL, 2, NULL );

    /* Start the scheduler so the created tasks start executing. */
    vTaskStartScheduler();

    /* As normal, vTaskStartScheduler() should not return, so the following lines
will never execute. */
    for( ;; );
    return 0;
}

```

Listing 63. Implementation of main() for Example 12

The first sending task uses xQueue1 to send a character pointer to the receiving task every 100 milliseconds. The second sending task uses xQueue2 to send a character pointer to the receiving task every 200 milliseconds. The character pointers are set to point to a string that identifies the sending task. The implementation of both sending tasks is shown in Listing 64.

```
void vSenderTask1( void *pvParameters )
{
const TickType_t xBlockTime = pdMS_TO_TICKS( 100 );
const char * const pcMessage = "Message from vSenderTask1\r\n";

    /* As per most tasks, this task is implemented within an infinite loop. */
    for( ;; )
    {
        /* Block for 100ms. */
        vTaskDelay( xBlockTime );

        /* Send this task's string to xQueue1. It is not necessary to use a block
        time, even though the queue can only hold one item. This is because the
        priority of the task that reads from the queue is higher than the priority of
        this task; as soon as this task writes to the queue it will be pre-empted by
        the task that reads from the queue, so the queue will already be empty again
        by the time the call to xQueueSend() returns. The block time is set to 0. */
        xQueueSend( xQueue1, &pcMessage, 0 );
    }
}
/*-----*/

void vSenderTask2( void *pvParameters )
{
const TickType_t xBlockTime = pdMS_TO_TICKS( 200 );
const char * const pcMessage = "Message from vSenderTask2\r\n";

    /* As per most tasks, this task is implemented within an infinite loop. */
    for( ;; )
    {
        /* Block for 200ms. */
        vTaskDelay( xBlockTime );

        /* Send this task's string to xQueue2. It is not necessary to use a block
        time, even though the queue can only hold one item. This is because the
        priority of the task that reads from the queue is higher than the priority of
        this task; as soon as this task writes to the queue it will be pre-empted by
        the task that reads from the queue, so the queue will already be empty again
        by the time the call to xQueueSend() returns. The block time is set to 0. */
        xQueueSend( xQueue2, &pcMessage, 0 );
    }
}
```

Listing 64. The sending tasks used in Example 12

The queues that are written to by the sending tasks are members of the same queue set. Each time a task sends to one of the queues, the handle of the queue is sent to the queue set. The receiving task calls `xQueueSelectFromSet()` to read the queue handles from the queue set. After the receiving task has received a queue handle from the set, it knows the queue referenced by the received handle contains data, so reads the data from the queue directly. The data it reads from the queue is a pointer to a string, which the receiving task prints out.

If a call to `xQueueSelectFromSet()` times out, then it will return `NULL`. In Example 12, `xQueueSelectFromSet()` is called with an indefinite block time, so will never time out, and can

only return a valid queue handle. Therefore, the receiving task does not need to check to see if `xQueueSelectFromSet()` returned `NULL` before the return value is used.

`xQueueSelectFromSet()` will only return a queue handle if the queue referenced by the handle contains data, so it is not necessary to use a block time when reading from the queue.

The implementation of the receive task is shown in Listing 65.

```
void vReceiverTask( void *pvParameters )
{
QueueHandle_t xQueueThatContainsData;
char *pcReceivedString;

/* As per most tasks, this task is implemented within an infinite loop. */
for( ;; )
{
/* Block on the queue set to wait for one of the queues in the set to contain data.
Cast the QueueSetMemberHandle_t value returned from xQueueSelectFromSet() to a
QueueHandle_t, as it is known all the members of the set are queues (the queue set
does not contain any semaphores). */
xQueueThatContainsData = ( QueueHandle_t ) xQueueSelectFromSet( xQueueSet,
                                                                portMAX_DELAY );

/* An indefinite block time was used when reading from the queue set, so
xQueueSelectFromSet() will not have returned unless one of the queues in the set
contained data, and xQueueThatContainsData cannot be NULL. Read from the queue. It
is not necessary to specify a block time because it is known the queue contains
data. The block time is set to 0. */
xQueueReceive( xQueueThatContainsData, &pcReceivedString, 0 );

/* Print the string received from the queue. */
vPrintString( pcReceivedString );
}
}
```

Listing 65. The receive task used in Example 12

Figure 37 shows the output produced by Example 12. It can be seen that the receiving task receives strings from both sending tasks. The block time used by `vSenderTask1()` is half of the block time used by `vSenderTask2()`, causing the strings sent by `vSenderTask1()` to be printed out twice as often as those sent by `vSenderTask2()`.

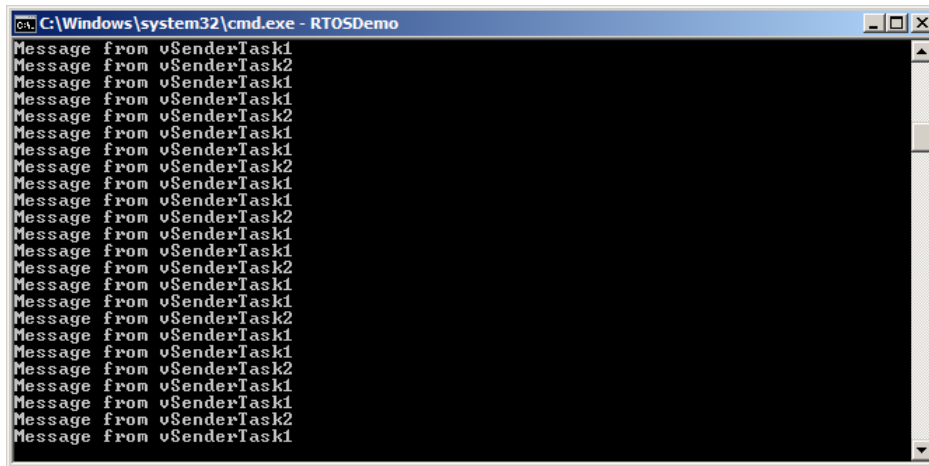

```
C:\Windows\system32\cmd.exe - RTOSDemo
Message from vSenderTask1
Message from vSenderTask2
Message from vSenderTask1
Message from vSenderTask1
Message from vSenderTask2
Message from vSenderTask1
Message from vSenderTask1
Message from vSenderTask2
Message from vSenderTask1
Message from vSenderTask1
Message from vSenderTask2
Message from vSenderTask1
Message from vSenderTask1
Message from vSenderTask2
Message from vSenderTask1
Message from vSenderTask1
Message from vSenderTask2
Message from vSenderTask1
Message from vSenderTask1
Message from vSenderTask2
```

Figure 37 The output produced when Example 12 is executed

More Realistic Queue Set Use Cases

Example 12 demonstrated a very simplistic case; the queue set only contained queues, and the two queues it contained were both used to send a character pointer. In a real application, a queue set might contain both queues and semaphores, and the queues might not all hold the same data type. When this is the case, it is necessary to test the value returned by `xQueueSelectFromSet()`, before the returned value is used. Listing 66 demonstrates how to use the value returned from `xQueueSelectFromSet()` when the set has the following members:

1. A binary semaphore.
2. A queue from which character pointers are read.
3. A queue from which `uint32_t` values are read.

Listing 66 assumes the queues and semaphore have already been created and added to the queue set.

```

/* The handle of the queue from which character pointers are received. */
QueueHandle_t xCharPointerQueue;

/* The handle of the queue from which uint32_t values are received. */
QueueHandle_t xUint32tQueue;

/* The handle of the binary semaphore. */
SemaphoreHandle_t xBinarySemaphore;

/* The queue set to which the two queues and the binary semaphore belong. */
QueueSetHandle_t xQueueSet;

void vAMoreRealisticReceiverTask( void *pvParameters )
{
QueueSetMemberHandle_t xHandle;
char *pcReceivedString;
uint32_t ulRecievedValue;
const TickType_t xDelay100ms = pdMS_TO_TICKS( 100 );

for( ;; )
{
/* Block on the queue set for a maximum of 100ms to wait for one of the members of
the set to contain data. */
xHandle = xQueueSelectFromSet( xQueueSet, xDelay100ms );

/* Test the value returned from xQueueSelectFromSet(). If the returned value is
NULL then the call to xQueueSelectFromSet() timed out. If the returned value is not
NULL then the returned value will be the handle of one of the set's members. The
QueueSetMemberHandle_t value can be cast to either a QueueHandle_t or a
SemaphoreHandle_t. Whether an explicit cast is required depends on the compiler. */

if( xHandle == NULL )
{
/* The call to xQueueSelectFromSet() timed out. */
}
else if( xHandle == ( QueueSetMemberHandle_t ) xCharPointerQueue )
{
/* The call to xQueueSelectFromSet() returned the handle of the queue that
receives character pointers. Read from the queue. The queue is known to contain
data, so a block time of 0 is used. */
xQueueReceive( xCharPointerQueue, &pcReceivedString, 0 );

/* The received character pointer can be processed here... */
}
else if( xHandle == ( QueueSetMemberHandle_t ) xUint32tQueue )
{
/* The call to xQueueSelectFromSet() returned the handle of the queue that
receives uint32_t types. Read from the queue. The queue is known to contain
data, so a block time of 0 is used. */
xQueueReceive( xUint32tQueue, &ulRecievedValue, 0 );

/* The received value can be processed here... */
}
else if( xHandle == ( QueueSetMemberHandle_t ) xBinarySemaphore )
{
/* The call to xQueueSelectFromSet() returned the handle of the binary semaphore.
Take the semaphore now. The semaphore is known to be available so a block time
of 0 is used. */
xSemaphoreTake( xBinarySemaphore, 0 );

/* Whatever processing is necessary when the semaphore is taken can be performed
here... */
}
}
}

```

Listing 66. Using a queue set that contains queues and semaphores

4.7 Using a Queue to Create a Mailbox

There is no consensus on terminology within the embedded community, and ‘mailbox’ will mean different things in different RTOSes. In this book the term mailbox is used to refer to a queue that has a length of one. A queue may get described as a mailbox because of the way it is used in the application, rather than because it has a functional difference to a queue:

- A queue is used to send data from one task to another task, or from an interrupt service routine to a task. The sender places an item in the queue, and the receiver removes the item from the queue. The data passes through the queue from the sender to the receiver.
- A mailbox is used to hold data that can be read by any task, or any interrupt service routine. The data does not pass through the mailbox, but instead remains in the mailbox until it is overwritten. The sender overwrites the value in the mailbox. The receiver reads the value from the mailbox, but does not remove the value from the mailbox.

This chapter describes two queue API functions that allow a queue to be used as a mailbox.

Listing 67 shows a queue being created for use as a mailbox.

```
/* A mailbox can hold a fixed size data item. The size of the data item is set
when the mailbox (queue) is created. In this example the mailbox is created to
hold an Example_t structure. Example_t includes a time stamp to allow the data held
in the mailbox to note the time at which the mailbox was last updated. The time
stamp used in this example is for demonstration purposes only - a mailbox can hold
any data the application writer wants, and the data does not need to include a time
stamp. */
typedef struct xExampleStructure
{
    TickType_t xTimeStamp;
    uint32_t ulValue;
} Example_t;

/* A mailbox is a queue, so its handle is stored in a variable of type
QueueHandle_t. */
QueueHandle_t xMailbox;

void vAFunction( void )
{
    /* Create the queue that is going to be used as a mailbox. The queue has a
length of 1 to allow it to be used with the xQueueOverwrite() API function, which
is described below. */
    xMailbox = xQueueCreate( 1, sizeof( Example_t ) );
}
}
```

Listing 67. A queue being created for use as a mailbox

The xQueueOverwrite() API Function

Like the xQueueSendToBack() API function, the xQueueOverwrite() API function sends data to a queue. Unlike xQueueSendToBack(), if the queue is already full, then xQueueOverwrite() will overwrite data that is already in the queue.

xQueueOverwrite() should only be used with queues that have a length of one. That restriction avoids the need for the function's implementation to make an arbitrary decision as to which item in the queue to overwrite, if the queue is full.

Note: Never call xQueueOverwrite() from an interrupt service routine. The interrupt-safe version xQueueOverwriteFromISR() should be used in its place.

```
BaseType_t xQueueOverwrite( QueueHandle_t xQueue, const void * pvItemToQueue );
```

Listing 68. The xQueueOverwrite() API function prototype

Table 26. xQueueOverwrite() parameters and return value

Parameter Name/ Returned Value	Description
xQueue	The handle of the queue to which the data is being sent (written). The queue handle will have been returned from the call to xQueueCreate() used to create the queue.
pvItemToQueue	A pointer to the data to be copied into the queue. The size of each item that the queue can hold is set when the queue is created, so this many bytes will be copied from pvItemToQueue into the queue storage area.
Returned value	xQueueOverwrite() will write to the queue even when the queue is full, so pdPASS is the only possible return value.

Listing 69 shows xQueueOverwrite() being used to write to the mailbox (queue) that was created in Listing 67.

```
void vUpdateMailbox( uint32_t ulNewValue )
{
    /* Example_t was defined in Listing 67. */
    Example_t xData;

    /* Write the new data into the Example_t structure.*/
    xData.ulValue = ulNewValue;

    /* Use the RTOS tick count as the time stamp stored in the Example_t structure. */
    xData.xTimeStamp = xTaskGetTickCount();

    /* Send the structure to the mailbox - overwriting any data that is already in the
    mailbox. */
    xQueueOverwrite( xMailbox, &xData );
}
```

Listing 69. Using the xQueueOverwrite() API function

The xQueuePeek() API Function

xQueuePeek() is used to receive (read) an item from a queue *without* the item being removed from the queue. xQueuePeek() receives data from the head of the queue, without modifying the data stored in the queue, or the order in which data is stored in the queue.

Note: Never call xQueuePeek() from an interrupt service routine. The interrupt-safe version xQueuePeekFromISR() should be used in its place.

xQueuePeek() has the same function parameters and return value as xQueueReceive().

```
BaseType_t xQueuePeek( QueueHandle_t xQueue,  
                      void * const pvBuffer,  
                      TickType_t xTicksToWait );
```

Listing 70. The xQueuePeek() API function prototype

Listing 71 shows xQueuePeek() being used to receive the item posted to the mailbox (queue) in Listing 69.

```
BaseType_t vReadMailbox( Example_t *pxData )  
{  
    TickType_t xPreviousTimeStamp;  
    BaseType_t xDataUpdated;  
  
    /* This function updates an Example_t structure with the latest value received  
    from the mailbox. Record the time stamp already contained in *pxData before it  
    gets overwritten by the new data. */  
    xPreviousTimeStamp = pxData->xTimeStamp;  
  
    /* Update the Example_t structure pointed to by pxData with the data contained in  
    the mailbox. If xQueueReceive() was used here then the mailbox would be left  
    empty, and the data could not then be read by any other tasks. Using  
    xQueuePeek() instead of xQueueReceive() ensures the data remains in the mailbox.  
    A block time is specified, so the calling task will be placed in the Blocked  
    state to wait for the mailbox to contain data should the mailbox be empty. An  
    infinite block time is used, so it is not necessary to check the value returned  
    from xQueuePeek(), as xQueuePeek() will only return when data is available. */  
    xQueuePeek( xMailbox, pxData, portMAX_DELAY );  
  
    /* Return pdTRUE if the value read from the mailbox has been updated since this  
    function was last called. Otherwise return pdFALSE. */  
    if( pxData->xTimeStamp > xPreviousTimeStamp )  
    {  
        xDataUpdated = pdTRUE;  
    }  
    else  
    {  
        xDataUpdated = pdFALSE;  
    }  
  
    return xDataUpdated;  
}
```

Listing 71. Using the xQueuePeek() API function

Chapter 5

Software Timer Management

5.1 Chapter Introduction and Scope

Software timers are used to schedule the execution of a function at a set time in the future, or periodically with a fixed frequency. The function executed by the software timer is called the software timer's callback function.

Software timers are implemented by, and are under the control of, the FreeRTOS kernel. They do not require hardware support, and are not related to hardware timers or hardware counters.

Note that, in line with the FreeRTOS philosophy of using innovative design to ensure maximum efficiency, software timers do not use any processing time unless a software timer callback function is actually executing.

Software timer functionality is optional. To include software timer functionality:

1. Build the FreeRTOS source file FreeRTOS/Source/timers.c as part of your project.
2. Set configUSE_TIMERS to 1 in FreeRTOSConfig.h.

Scope

This chapter aims to give readers a good understanding of:

- The characteristics of a software timer compared to the characteristics of a task.
- The RTOS daemon task.
- The timer command queue.
- The difference between a one shot software timer and a periodic software timer.
- How to create, start, reset and change the period of a software timer.

5.2 Software Timer Callback Functions

Software timer callback functions are implemented as C functions. The only thing special about them is their prototype, which must return void, and take a handle to a software timer as its only parameter. The callback function prototype is demonstrated by Listing 72.

```
void ATimerCallback( TimerHandle_t xTimer );
```

Listing 72. The software timer callback function prototype

Software timer callback functions execute from start to finish, and exit in the normal way. They should be kept short, and must not enter the Blocked state.

Note: As will be seen, software timer callback functions execute in the context of a task that is created automatically when the FreeRTOS scheduler is started. Therefore, it is essential that software timer callback functions never call FreeRTOS API functions that will result in the calling task entering the Blocked state. It is ok to call functions such as xQueueReceive(), but only if the function's xTicksToWait parameter (which specifies the function's block time) is set to 0. It is not ok to call functions such as vTaskDelay(), as calling vTaskDelay() will always place the calling task into the Blocked state.

5.3 Attributes and States of a Software Timer

Period of a Software Timer

A software timer's 'period' is the time between the software timer being started, and the software timer's callback function executing.

One-shot and Auto-reload Timers

There are two types of software timer:

1. One-shot timers

Once started, a one-shot timer will execute its callback function once only. A one-shot timer can be restarted manually, but will not restart itself.

2. Auto-reload timers

Once started, an auto-reload timer will re-start itself each time it expires, resulting in periodic execution of its callback function.

Figure 38 shows the difference in behavior between a one-shot timer and an auto-reload timer. The dashed vertical lines mark the times at which a tick interrupt occurs.

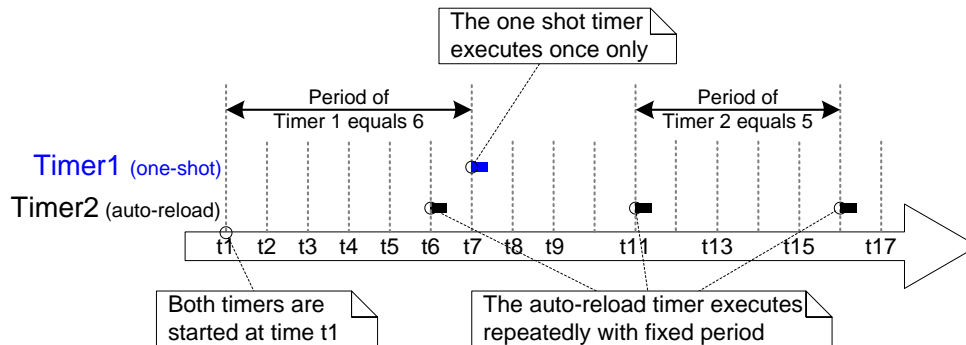

Figure 38 The difference in behavior between one-shot and auto-reload software timers

Referring to Figure 38:

- Timer 1

Timer 1 is a one-shot timer that has a period of 6 ticks. It is started at time t_1 , so its callback function executes 6 ticks later, at time t_7 . As timer 1 is a one-shot timer, its callback function does not execute again.

- Timer 2

Timer 2 is an auto-reload timer that has a period of 5 ticks. It is started at time t_1 , so its callback function executes every 5 ticks after time t_1 . In Figure 38 this is at times t_6 , t_{11} and t_{16} .

Software Timer States

A software timer can be in one of the following two states:

- Dormant

A Dormant software timer exists, and can be referenced by its handle, but is not running, so its callback functions will not execute.

- Running

A Running software timer will execute its callback function after a time equal to its period has elapsed since the software timer entered the Running state, or since the software timer was last reset.

Figure 39 and Figure 40 show the possible transitions between the Dormant and Running states for an auto-reload timer and a one-shot timer respectively. The key difference between the two diagrams is the state entered after the timer has expired; the auto-reload timer executes its callback function then re-enters the Running state, the one-shot timer executes its callback function then enters the Dormant state.

The `xTimerDelete()` API function deletes a timer. A timer can be deleted at any time.

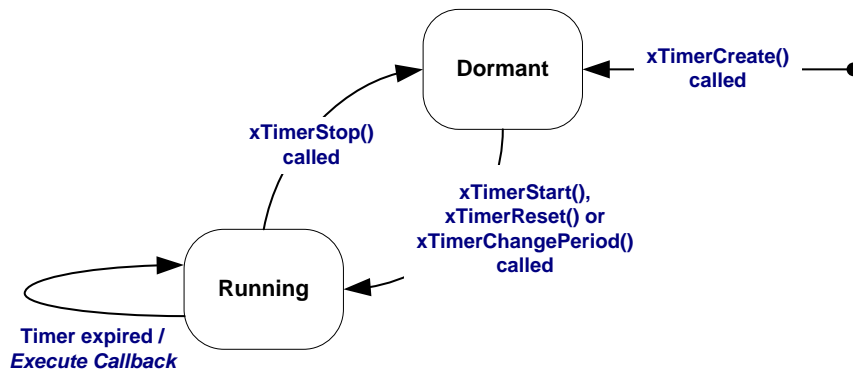

Figure 39 Auto-reload software timer states and transitions

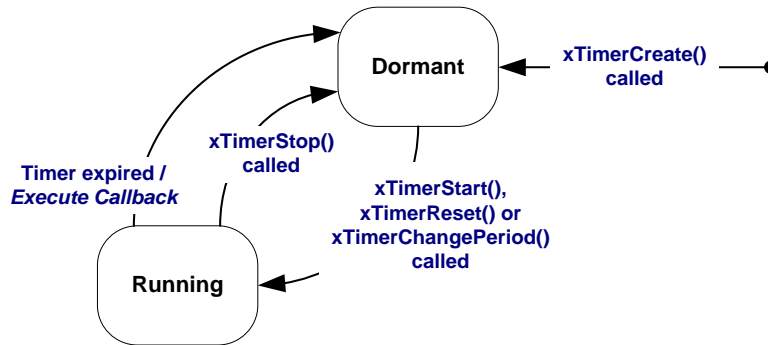

Figure 40 One-shot software timer states and transitions

5.4 The Context of a Software Timer

The RTOS Daemon (Timer Service) Task

All software timer callback functions execute in the context of the same RTOS daemon (or 'timer service') task¹.

The daemon task is a standard FreeRTOS task that is created automatically when the scheduler is started. Its priority and stack size are set by the `configTIMER_TASK_PRIORITY` and `configTIMER_TASK_STACK_DEPTH` compile time configuration constants respectively. Both constants are defined within `FreeRTOSConfig.h`.

Software timer callback functions must not call FreeRTOS API functions that will result in the calling task entering the Blocked state, as to do so will result in the daemon task entering the Blocked state.

The Timer Command Queue

Software timer API functions send commands from the calling task to the daemon task on a queue called the 'timer command queue'. This is shown in Figure 41. Examples of commands include 'start a timer', 'stop a timer' and 'reset a timer'.

The timer command queue is a standard FreeRTOS queue that is created automatically when the scheduler is started. The length of the timer command queue is set by the `configTIMER_QUEUE_LENGTH` compile time configuration constant in `FreeRTOSConfig.h`.

¹ The task used to be called the 'timer service task', because originally it was only used to execute software timer callback functions. Now the same task is used for other purposes too, so it is known by the more generic name of the 'RTOS daemon task'.

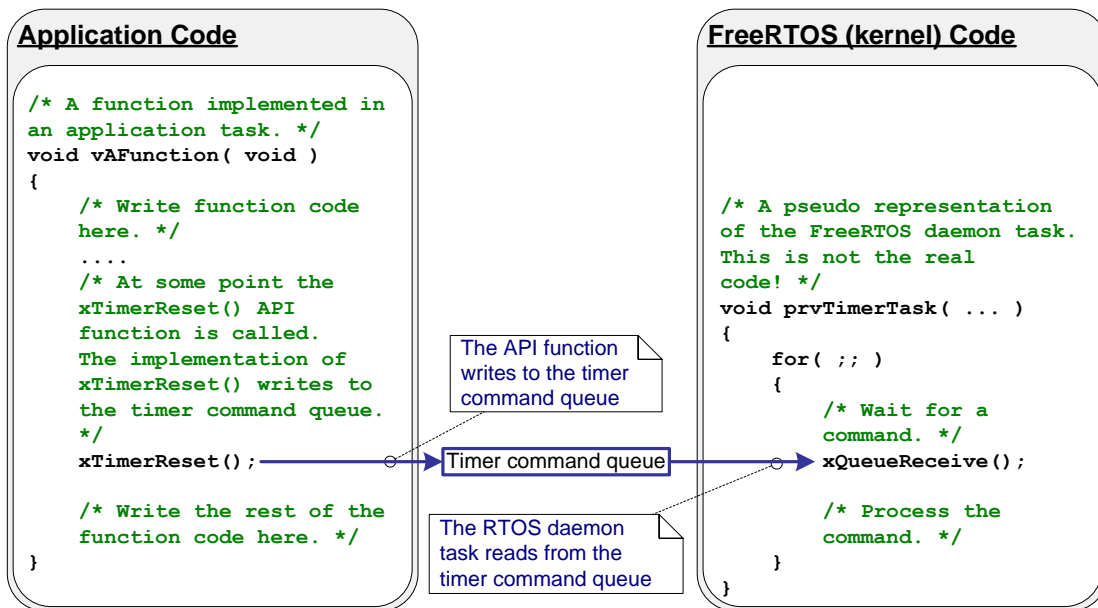

Figure 41 The timer command queue being used by a software timer API function to communicate with the RTOS daemon task

Daemon Task Scheduling

The daemon task is scheduled like any other FreeRTOS task; it will only process commands, or execute timer callback functions, when it is the highest priority task that is able to run. Figure 42 and Figure 43 demonstrate how the configTIMER_TASK_PRIORITY setting affects the execution pattern.

Figure 42 shows the execution pattern when the priority of the daemon task is below the priority of a task that calls the xTimerStart() API function.

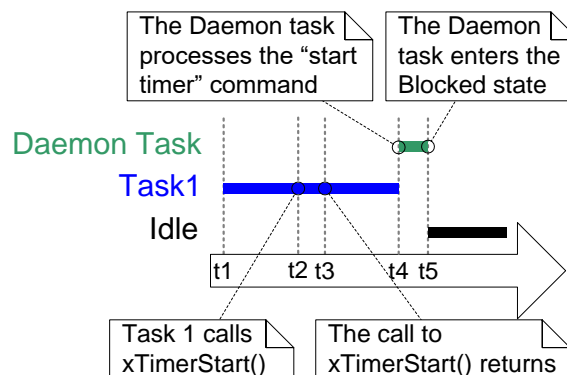

Figure 42 The execution pattern when the priority of a task calling xTimerStart() is above the priority of the daemon task

Referring to Figure 42, in which the priority of Task 1 is higher than the priority of the daemon task, and the priority of the daemon task is higher than the priority of the Idle task:

1. At time t1

Task 1 is in the Running state, and the daemon task is in the Blocked state.

The daemon task will leave the Blocked state if a command is sent to the timer command queue, in which case it will process the command, or if a software timer expires, in which case it will execute the software timer's callback function.

2. At time t2

Task 1 calls `xTimerStart()`.

`xTimerStart()` sends a command to the timer command queue, causing the daemon task to leave the Blocked state. The priority of Task 1 is higher than the priority of the daemon task, so the daemon task does not pre-empt Task 1.

Task 1 is still in the Running state, and the daemon task has left the Blocked state and entered the Ready state.

3. At time t3

Task 1 completes executing the `xTimerStart()` API function. Task 1 executed `xTimerStart()` from the start of the function to the end of the function, without leaving the Running state.

4. At time t4

Task 1 calls an API function that results in it entering the Blocked state. The daemon task is now the highest priority task in the Ready state, so the scheduler selects the daemon task as the task to enter the Running state. The daemon task then starts to process the command sent to the timer command queue by Task 1.

Note: The time at which the software timer being started will expire is calculated from the time the 'start a timer' command was sent to the timer command queue—it is not calculated from the time the daemon task received the 'start a timer' command from the timer command queue.

5. At time t5

The daemon task has completed processing the command sent to it by Task 1, and attempts to receive more data from the timer command queue. The timer command queue is empty, so the daemon task re-enters the Blocked state. The daemon task will leave the Blocked state again if a command is sent to the timer command queue, or if a software timer expires.

The Idle task is now the highest priority task in the Ready state, so the scheduler selects the Idle task as the task to enter the Running state.

Figure 43 shows a similar scenario to that shown by Figure 42, but this time the priority of the daemon task is above the priority of the task that calls `xTimerStart()`.

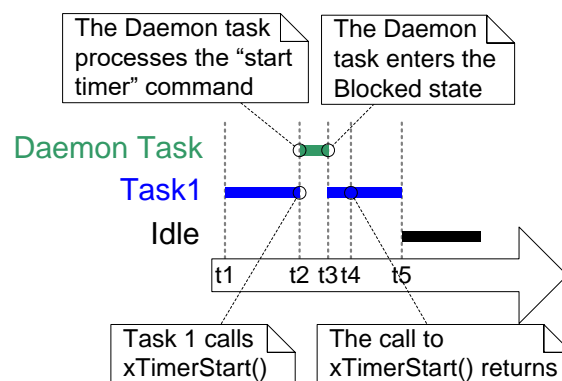

Figure 43 The execution pattern when the priority of a task calling `xTimerStart()` is below the priority of the daemon task

Referring to Figure 43, in which the priority of the daemon task is higher than the priority of Task 1, and the priority of the Task 1 is higher than the priority of the Idle task:

1. At time t1

As before, Task 1 is in the Running state, and the daemon task is in the Blocked state.

2. At time t2

Task 1 calls `xTimerStart()`.

`xTimerStart()` sends a command to the timer command queue, causing the daemon task to leave the Blocked state. The priority of the daemon task is higher than the priority of Task 1, so the scheduler selects the daemon task as the task to enter the Running state.

Task 1 was pre-empted by the daemon task before it had completed executing the `xTimerStart()` function, and is now in the Ready state.

The daemon task starts to process the command sent to the timer command queue by Task 1.

3. At time t_3

The daemon task has completed processing the command sent to it by Task 1, and attempts to receive more data from the timer command queue. The timer command queue is empty, so the daemon task re-enters the Blocked state.

Task 1 is now the highest priority task in the Ready state, so the scheduler selects Task 1 as the task to enter the Running state.

4. At time t_4

Task 1 was pre-empted by the daemon task before it had completed executing the `xTimerStart()` function, and only exits (returns from) `xTimerStart()` after it has re-entered the Running state.

5. At time t_5

Task 1 calls an API function that results in it entering the Blocked state. The Idle task is now the highest priority task in the Ready state, so the scheduler selects the Idle task as the task to enter the Running state.

In the scenario shown by Figure 42, time passed between Task 1 sending a command to the timer command queue, and the daemon task receiving and processing the command. In the scenario shown by Figure 43, the daemon task had received and processed the command sent to it by Task 1 before Task 1 returned from the function that sent the command.

Commands sent to the timer command queue contain a time stamp. The time stamp is used to account for any time that passes between a command being sent by an application task, and the same command being processed by the daemon task. For example, if a 'start a timer' command is sent to start a timer that has a period of 10 ticks, the time stamp is used to ensure the timer being started expires 10 ticks after the command was sent, not 10 ticks after the command was processed by the daemon task.

5.5 Creating and Starting a Software Timer

The xTimerCreate() API Function

FreeRTOS V9.0.0 also includes the `xTimerCreateStatic()` function, which allocates the memory required to create a timer statically at compile time: A software timer must be explicitly created before it can be used.

Software timers are referenced by variables of type `TimerHandle_t`. `xTimerCreate()` is used to create a software timer and returns a `TimerHandle_t` to reference the software timer it creates. Software timers are created in the Dormant state.

Software timers can be created before the scheduler is running, or from a task after the scheduler has been started.

Section 0 describes the data types and naming conventions used.

```
TimerHandle_t xTimerCreate( const char * const pcTimerName,
                            TickType_t xTimerPeriodInTicks,
                            UBaseType_t uxAutoReload,
                            void * pvTimerID,
                            TimerCallbackFunction_t pxCallbackFunction );
```

Listing 73. The `xTimerCreate()` API function prototype

Table 27. `xTimerCreate()` parameters and return value

Parameter Name/ Returned Value	Description
<code>pcTimerName</code>	A descriptive name for the timer. This is not used by FreeRTOS in any way. It is included purely as a debugging aid. Identifying a timer by a human readable name is much simpler than attempting to identify it by its handle.
<code>xTimerPeriodInTicks</code>	The timer's period specified in ticks. The <code>pdMS_TO_TICKS()</code> macro can be used to convert a time specified in milliseconds into a time specified in ticks.
<code>uxAutoReload</code>	Set <code>uxAutoReload</code> to <code>pdTRUE</code> to create an auto-reload timer. Set <code>uxAutoReload</code> to <code>pdFALSE</code> to create a one-shot timer.

Table 27. xTimerCreate() parameters and return value

Parameter Name/ Returned Value	Description
pvTimerID	<p>Each software timer has an ID value. The ID is a void pointer, and can be used by the application writer for any purpose. The ID is particularly useful when the same callback function is used by more than one software timer, as it can be used to provide timer specific storage. Use of a timer's ID is demonstrated in an example within this chapter.</p> <p>pvTimerID sets an initial value for the ID of the task being created.</p>
pxCallbackFunction	<p>Software timer callback functions are simply C functions that conform to the prototype shown in Listing 72. The pxCallbackFunction parameter is a pointer to the function (in effect, just the function name) to use as the callback function for the software timer being created.</p>
Returned value	<p>If NULL is returned, then the software timer cannot be created because there is insufficient heap memory available for FreeRTOS to allocate the necessary data structure.</p> <p>A non-NULL value being returned indicates that the software timer has been created successfully. The returned value is the handle of the created timer.</p> <p>Chapter 2 provides more information on heap memory management.</p>

The xTimerStart() API Function

xTimerStart() is used to start a software timer that is in the Dormant state, or reset (re-start) a software timer that is in the Running state. xTimerStop() is used to stop a software timer that is in the Running state. Stopping a software timer is the same as transitioning the timer into the Dormant state.

xTimerStart() can be called before the scheduler is started, but when this is done, the software timer will not actually start until the time at which the scheduler starts.

Note: Never call xTimerStart() from an interrupt service routine. The interrupt-safe version xTimerStartFromISR() should be used in its place.

```
BaseType_t xTimerStart( TimerHandle_t xTimer, TickType_t xTicksToWait );
```

Listing 74. The xTimerStart() API function prototype

Table 28. xTimerStart() parameters and return value

Parameter Name/ Returned Value	Description
xTimer	The handle of the software timer being started or reset. The handle will have been returned from the call to xTimerCreate() used to create the software timer.

Table 28. xTimerStart() parameters and return value

Parameter Name/ Returned Value	Description
xTicksToWait	<p>xTimerStart() uses the timer command queue to send the 'start a timer' command to the daemon task. xTicksToWait specifies the maximum amount of time the calling task should remain in the Blocked state to wait for space to become available on the timer command queue, should the queue already be full.</p> <p>xTimerStart() will return immediately if xTicksToWait is zero and the timer command queue is already full.</p> <p>The block time is specified in tick periods, so the absolute time it represents is dependent on the tick frequency. The macro pdMS_TO_TICKS() can be used to convert a time specified in milliseconds into a time specified in ticks.</p> <p>If INCLUDE_vTaskSuspend is set to 1 in FreeRTOSConfig.h then setting xTicksToWait to portMAX_DELAY will result in the calling task remaining in the Blocked state indefinitely (without a timeout) to wait for space to become available in the timer command queue.</p> <p>If xTimerStart() is called before the scheduler has been started then the value of xTicksToWait is ignored, and xTimerStart() behaves as if xTicksToWait had been set to zero.</p>

Table 28. xTimerStart() parameters and return value

Parameter Name/ Returned Value	Description
Returned value	<p>There are two possible return values:</p> <ol style="list-style-type: none"><li data-bbox="561 411 721 443">1. pdPASS <p>pdPASS will be returned only if the 'start a timer' command was successfully sent to the timer command queue.</p> <p>If the priority of the daemon task is above the priority of the task that called xTimerStart(), then the scheduler will ensure the start command is processed before xTimerStart() returns. This is because the daemon task will pre-empt the task that called xTimerStart() as soon as there is data in the timer command queue.</p> <p>If a block time was specified (xTicksToWait was not zero), then it is possible the calling task was placed into the Blocked state to wait for space to become available in the timer command queue before the function returned, but data was successfully written to the timer command queue before the block time expired.</p> <ol style="list-style-type: none"><li data-bbox="561 1241 737 1272">1. pdFALSE <p>pdFALSE will be returned if the 'start a timer' command could not be written to the timer command queue because the queue was already full.</p> <p>If a block time was specified (xTicksToWait was not zero) then the calling task will have been placed into the Blocked state to wait for the daemon task to make room in the timer command queue, but the specified block time expired before that happened.</p>

Example 13. Creating one-shot and auto-reload timers

This example creates and starts a one-shot timer and an auto-reload timer—as shown in Listing 75.

```
/* The periods assigned to the one-shot and auto-reload timers are 3.333 second and half a
second respectively. */
#define mainONE_SHOT_TIMER_PERIOD    pdMS_TO_TICKS( 3333 )
#define mainAUTO_RELOAD_TIMER_PERIOD pdMS_TO_TICKS( 500 )

int main( void )
{
    TimerHandle_t xAutoReloadTimer, xOneShotTimer;
    BaseType_t xTimer1Started, xTimer2Started;

    /* Create the one shot timer, storing the handle to the created timer in xOneShotTimer. */
    xOneShotTimer = xTimerCreate(
        /* Text name for the software timer - not used by FreeRTOS. */
        "OneShot",
        /* The software timer's period in ticks. */
        mainONE_SHOT_TIMER_PERIOD,
        /* Setting uxAutoRealod to pdFALSE creates a one-shot software timer. */
        pdFALSE,
        /* This example does not use the timer id. */
        0,
        /* The callback function to be used by the software timer being created. */
        prvOneShotTimerCallback );

    /* Create the auto-reload timer, storing the handle to the created timer in xAutoReloadTimer. */
    xAutoReloadTimer = xTimerCreate(
        /* Text name for the software timer - not used by FreeRTOS. */
        "AutoReload",
        /* The software timer's period in ticks. */
        mainAUTO_RELOAD_TIMER_PERIOD,
        /* Setting uxAutoRealod to pdTRUE creates an auto-reload timer. */
        pdTRUE,
        /* This example does not use the timer id. */
        0,
        /* The callback function to be used by the software timer being created. */
        prvAutoReloadTimerCallback );

    /* Check the software timers were created. */
    if( ( xOneShotTimer != NULL ) && ( xAutoReloadTimer != NULL ) )
    {
        /* Start the software timers, using a block time of 0 (no block time). The scheduler has
        not been started yet so any block time specified here would be ignored anyway. */
        xTimer1Started = xTimerStart( xOneShotTimer, 0 );
        xTimer2Started = xTimerStart( xAutoReloadTimer, 0 );

        /* The implementation of xTimerStart() uses the timer command queue, and xTimerStart()
        will fail if the timer command queue gets full. The timer service task does not get
        created until the scheduler is started, so all commands sent to the command queue will
        stay in the queue until after the scheduler has been started. Check both calls to
        xTimerStart() passed. */
        if( ( xTimer1Started == pdPASS ) && ( xTimer2Started == pdPASS ) )
        {
            /* Start the scheduler. */
            vTaskStartScheduler();
        }
    }

    /* As always, this line should not be reached. */
    for( ;; );
}
```

Listing 75. Creating and starting the timers used in Example 13

The timers' callback functions just print a message each time they are called. The implementation of the one-shot timer callback function is shown in Listing 76. The implementation of the auto-reload timer callback function is shown in Listing 77.

```
static void prvOneShotTimerCallback( TimerHandle_t xTimer )
{
TickType_t xTimeNow;

    /* Obtain the current tick count. */
    xTimeNow = xTaskGetTickCount();

    /* Output a string to show the time at which the callback was executed. */
    vPrintStringAndNumber( "One-shot timer callback executing", xTimeNow );

    /* File scope variable. */
    ulCallCount++;
}
```

Listing 76. The callback function used by the one-shot timer in Example 13

```
static void prvAutoReloadTimerCallback( TimerHandle_t xTimer )
{
TickType_t xTimeNow;

    /* Obtain the current tick count. */
    xTimeNow = uxTaskGetTickCount();

    /* Output a string to show the time at which the callback was executed. */
    vPrintStringAndNumber( "Auto-reload timer callback executing", xTimeNow );

    ulCallCount++;
}
```

Listing 77. The callback function used by the auto-reload timer in Example 13

Executing this example produces the output shown in Figure 44. Figure 44 shows the auto-reload timer's callback function executing with a fixed period of 500 ticks (mainAUTO_RELOAD_TIMER_PERIOD is set to 500 in Listing 75), and the one-shot timer's callback function executing only once, when the tick count is 3333 (mainONE_SHOT_TIMER_PERIOD is set to 3333 in Listing 75).

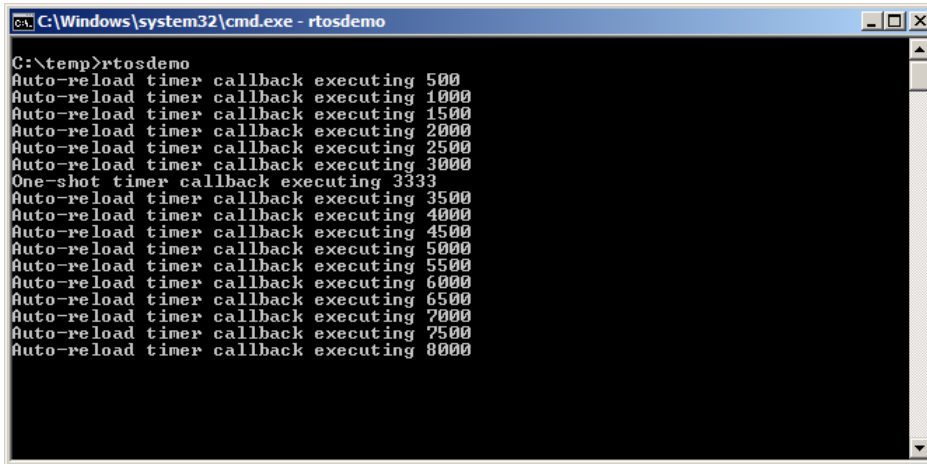

```
C:\Windows\system32\cmd.exe - rtosdemo
C:\temp>rtosdemo
Auto-reload timer callback executing 500
Auto-reload timer callback executing 1000
Auto-reload timer callback executing 1500
Auto-reload timer callback executing 2000
Auto-reload timer callback executing 2500
Auto-reload timer callback executing 3000
One-shot timer callback executing 3333
Auto-reload timer callback executing 3500
Auto-reload timer callback executing 4000
Auto-reload timer callback executing 4500
Auto-reload timer callback executing 5000
Auto-reload timer callback executing 5500
Auto-reload timer callback executing 6000
Auto-reload timer callback executing 6500
Auto-reload timer callback executing 7000
Auto-reload timer callback executing 7500
Auto-reload timer callback executing 8000
```

Figure 44 The output produced when Example 13 is executed

5.6 The Timer ID

Each software timer has an ID, which is a tag value that can be used by the application writer for any purpose. The ID is stored in a void pointer (void *), so can store an integer value directly, point to any other object, or be used as a function pointer.

An initial value is assigned to the ID when the software timer is created—after which the ID can be updated using the `vTimerSetTimerID()` API function, and queried using the `pvTimerGetTimerID()` API function.

Unlike other software timer API functions, `vTimerSetTimerID()` and `pvTimerGetTimerID()` access the software timer directly—they do not send a command to the timer command queue.

The `vTimerSetTimerID()` API Function

```
void vTimerSetTimerID( const TimerHandle_t xTimer, void *pvNewID );
```

Listing 78. The `vTimerSetTimerID()` API function prototype

Table 29. `vTimerSetTimerID()` parameters

Parameter Name/ Returned Value	Description
<code>xTimer</code>	The handle of the software timer being updated with a new ID value. The handle will have been returned from the call to <code>xTimerCreate()</code> used to create the software timer.
<code>pvNewID</code>	The value to which the software timer's ID will be set.

The `pvTimerGetTimerID()` API Function

```
void *pvTimerGetTimerID( TimerHandle_t xTimer );
```

Listing 79. The `pvTimerGetTimerID()` API function prototype

Table 30. pvTimerGetTimerID() parameters and return value

Parameter Name/ Returned Value	Description
xTimer	The handle of the software timer being queried. The handle will have been returned from the call to xTimerCreate() used to create the software timer.
Returned value	The ID of the software timer being queried.

Example 14. Using the callback function parameter and the software timer ID

The same callback function can be assigned to more than one software timer. When that is done, the callback function parameter is used to determine which software timer expired.

Example 13 used two separate callback functions; one callback function was used by the one-shot timer, and the other callback function was used by the auto-reload timer. Example 14 creates similar functionality to that created by Example 13, but assigns a single callback function to both software timers.

The main() function used by Example 14 is almost identical to the main() function used in Example 13. The only difference is where the software timers are created. This difference is shown in Listing 80, where prvTimerCallback() is used as the callback function for both timers.

```
/* Create the one shot timer software timer, storing the handle in xOneShotTimer. */
xOneShotTimer = xTimerCreate( "OneShot",
    mainONE_SHOT_TIMER_PERIOD,
    pdFALSE,
    /* The timer's ID is initialized to 0. */
    0,
    /* prvTimerCallback() is used by both timers. */
    prvTimerCallback );

/* Create the auto-reload software timer, storing the handle in xAutoReloadTimer */
xAutoReloadTimer = xTimerCreate( "AutoReload",
    mainAUTO_RELOAD_TIMER_PERIOD,
    pdTRUE,
    /* The timer's ID is initialized to 0. */
    0,
    /* prvTimerCallback() is used by both timers. */
    prvTimerCallback );
```

Listing 80. Creating the timers used in Example 14

prvTimerCallback() will execute when either timer expires. The implementation of prvTimerCallback() uses the function's parameter to determine if it was called because the one-shot timer expired, or because the auto-reload timer expired.

prvTimerCallback() also demonstrates how to use the software timer ID as timer specific storage; each software timer keeps a count of the number of times it has expired in its own ID, and the auto-reload timer uses the count to stop itself the fifth time it executes.

The implementation of prvTimerCallback() is shown in Listing 79.

```
static void prvTimerCallback( TimerHandle_t xTimer )
{
TickType_t xTimeNow;
uint32_t ulExecutionCount;

    /* A count of the number of times this software timer has expired is stored in the timer's
    ID. Obtain the ID, increment it, then save it as the new ID value. The ID is a void
    pointer, so is cast to a uint32_t. */
    ulExecutionCount = ( uint32_t ) prvTimerGetTimerID( xTimer );
    ulExecutionCount++;
    vTimerSetTimerID( xTimer, ( void * ) ulExecutionCount );

    /* Obtain the current tick count. */
    xTimeNow = xTaskGetTickCount();

    /* The handle of the one-shot timer was stored in xOneShotTimer when the timer was created.
    Compare the handle passed into this function with xOneShotTimer to determine if it was the
    one-shot or auto-reload timer that expired, then output a string to show the time at which
    the callback was executed. */
    if( xTimer == xOneShotTimer )
    {
        vPrintStringAndNumber( "One-shot timer callback executing", xTimeNow );
    }
    else
    {
        /* xTimer did not equal xOneShotTimer, so it must have been the auto-reload timer that
        expired. */
        vPrintStringAndNumber( "Auto-reload timer callback executing", xTimeNow );

        if( ulExecutionCount == 5 )
        {
            /* Stop the auto-reload timer after it has executed 5 times. This callback function
            executes in the context of the RTOS daemon task so must not call any functions that
            might place the daemon task into the Blocked state. Therefore a block time of 0 is
            used. */
            xTimerStop( xTimer, 0 );
        }
    }
}
```

Listing 81. The timer callback function used in Example 14

The output produced by Example 14 is shown in Figure 45. It can be seen that the auto-reload timer only executes five times.

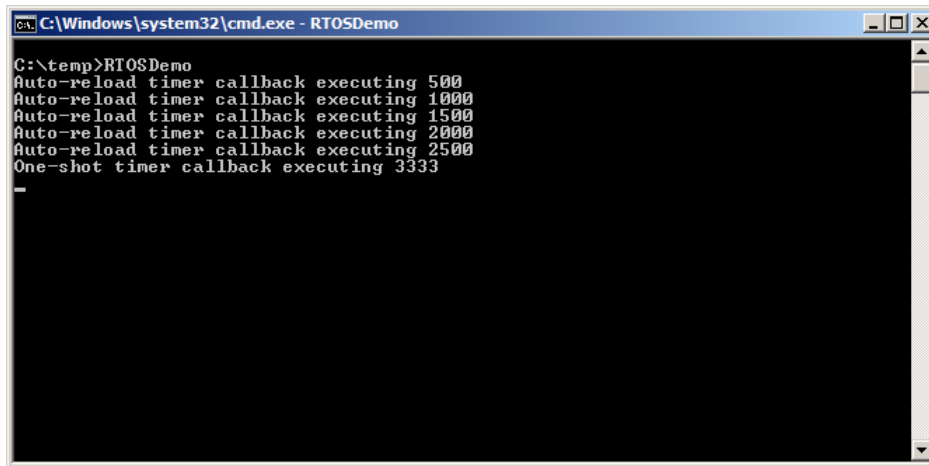

```
C:\Windows\system32\cmd.exe - RTOSDemo
C:\temp>RTOSDemo
Auto-reload timer callback executing 500
Auto-reload timer callback executing 1000
Auto-reload timer callback executing 1500
Auto-reload timer callback executing 2000
Auto-reload timer callback executing 2500
One-shot timer callback executing 3333
-
```

Figure 45 The output produced when Example 14 is executed

5.7 Changing the Period of a Timer

Every official FreeRTOS port is provided with one or more example projects. Most example projects are self-checking, and an LED is used to give visual feedback of the project's status; if the self-checks have always passed then the LED is toggled slowly, if a self-check has ever failed then the LED is toggled quickly.

Some example projects perform the self-checks in a task, and use the `vTaskDelay()` function to control the rate at which the LED toggles. Other example projects perform the self-checks in a software timer callback function, and use the timer's period to control the rate at which the LED toggles.

The `xTimerChangePeriod()` API Function

The period of a software timer is changed using the `xTimerChangePeriod()` function.

If `xTimerChangePeriod()` is used to change the period of a timer that is already running, then the timer will use the new period value to recalculate its expiry time. The recalculated expiry time is relative to when `xTimerChangePeriod()` was called, not relative to when the timer was originally started.

If `xTimerChangePeriod()` is used to change the period of a timer that is in the Dormant state (a timer that is not running), then the timer will calculate an expiry time, and transition to the Running state (the timer will start running).

Note: Never call `xTimerChangePeriod()` from an interrupt service routine. The interrupt-safe version `xTimerChangePeriodFromISR()` should be used in its place.

```
BaseType_t xTimerChangePeriod( TimerHandle_t xTimer,  
                               TickType_t xNewTimerPeriodInTicks,  
                               TickType_t xTicksToWait );
```

Listing 82. The `xTimerChangePeriod()` API function prototype

Table 31. xTimerChangePeriod() parameters and return value

Parameter Name/ Returned Value	Description
xTimer	The handle of the software timer being updated with a new period value. The handle will have been returned from the call to xTimerCreate() used to create the software timer.
xTimerPeriodInTicks	The new period for the software timer, specified in ticks. The pdMS_TO_TICKS() macro can be used to convert a time specified in milliseconds into a time specified in ticks.
xTicksToWait	<p>xTimerChangePeriod() uses the timer command queue to send the 'change period' command to the daemon task. xTicksToWait specifies the maximum amount of time the calling task should remain in the Blocked state to wait for space to become available on the timer command queue, should the queue already be full.</p> <p>xTimerChangePeriod() will return immediately if xTicksToWait is zero and the timer command queue is already full.</p> <p>The macro pdMS_TO_TICKS() can be used to convert a time specified in milliseconds into a time specified in ticks.</p> <p>If INCLUDE_vTaskSuspend is set to 1 in FreeRTOSConfig.h, then setting xTicksToWait to portMAX_DELAY will result in the calling task remaining in the Blocked state indefinitely (without a timeout) to wait for space to become available in the timer command queue.</p> <p>If xTimerChangePeriod() is called before the scheduler has been started, then the value of xTicksToWait is ignored, and xTimerChangePeriod() behaves as if xTicksToWait had been set to zero.</p>

Table 31. xTimerChangePeriod() parameters and return value

Parameter Name/ Returned Value	Description
Returned value	<p>There are two possible return values:</p> <ol style="list-style-type: none"><li data-bbox="561 411 721 443">1. pdPASS <p>pdPASS will be returned only if data was successfully sent to the timer command queue.</p> <p>If a block time was specified (xTicksToWait was not zero), then it is possible the calling task was placed into the Blocked state to wait for space to become available in the timer command queue before the function returned, but data was successfully written to the timer command queue before the block time expired.</p> <ol style="list-style-type: none"><li data-bbox="561 909 737 940">2. pdFALSE <p>pdFALSE will be returned if the 'change period' command could not be written to the timer command queue because the queue was already full.</p> <p>If a block time was specified (xTicksToWait was not zero) then the calling task will have been placed into the Blocked state to wait for the daemon task to make room in the queue, but the specified block time expired before that happened.</p>

Listing 83 shows how the FreeRTOS examples that include self-checking functionality in a software timer callback function use xTimerChangePeriod() to increase the rate at which an LED toggles if a self-check fails. The software timer that performs the self-checks is referred to as the 'check timer'.

```
/* The check timer is created with a period of 3000 milliseconds, resulting in the LED toggling
every 3 seconds. If the self-checking functionality detects an unexpected state, then the check
timer's period is changed to just 200 milliseconds, resulting in a much faster toggle rate. */
const TickType_t xHealthyTimerPeriod = pdMS_TO_TICKS( 3000 );
const TickType_t xErrorTimerPeriod = pdMS_TO_TICKS( 200 );

/* The callback function used by the check timer. */
static void prvCheckTimerCallbackFunction( TimerHandle_t xTimer )
{
    static BaseType_t xErrorDetected = pdFALSE;

    if( xErrorDetected == pdFALSE )
    {
        /* No errors have yet been detected. Run the self-checking function again. The
        function asks each task created by the example to report its own status, and also checks
        that all the tasks are actually still running (and so able to report their status
        correctly). */
        if( CheckTasksAreRunningWithoutError() == pdFAIL )
        {
            /* One or more tasks reported an unexpected status. An error might have occurred.
            Reduce the check timer's period to increase the rate at which this callback function
            executes, and in so doing also increase the rate at which the LED is toggled. This
            callback function is executing in the context of the RTOS daemon task, so a block
            time of 0 is used to ensure the Daemon task never enters the Blocked state. */
            xTimerChangePeriod( xTimer, /* The timer being updated. */
                               xErrorTimerPeriod, /* The new period for the timer. */
                               0 ); /* Do not block when sending this command. */
        }

        /* Latch that an error has already been detected. */
        xErrorDetected = pdTRUE;
    }

    /* Toggle the LED. The rate at which the LED toggles will depend on how often this function
    is called, which is determined by the period of the check timer. The timer's period will
    have been reduced from 3000ms to just 200ms if CheckTasksAreRunningWithoutError() has ever
    returned pdFAIL. */
    ToggleLED();
}
}
```

Listing 83. Using xTimerChangePeriod()

5.8 Resetting a Software Timer

Resetting a software timer means to re-start the timer; the timer's expiry time is recalculated to be relative to when the timer was reset, rather than when the timer was originally started. This is demonstrated by Figure 46, which shows a timer that has a period of 6 being started, then reset twice, before eventually expiring and executing its callback function.

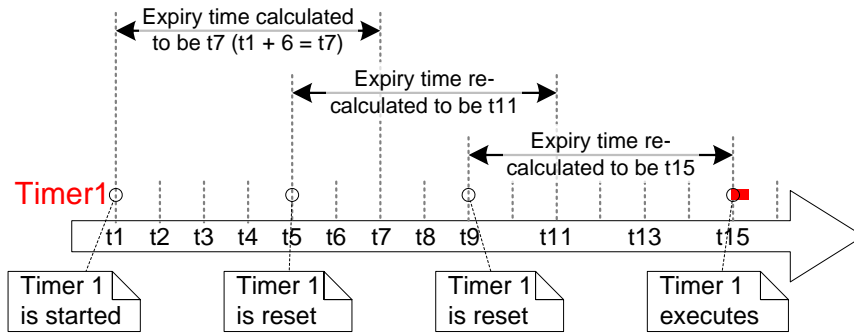

Figure 46 Starting and resetting a software timer that has a period of 6 ticks

Referring to Figure 46:

- Timer 1 is started at time t1. It has a period of 6, so the time at which it will execute its callback function is originally calculated to be t7, which is 6 ticks after it was started.
- Timer 1 is reset before time t7 is reached, so before it had expired and executed its callback function. Timer 1 is reset at time t5, so the time at which it will execute its callback function is re-calculated to be t11, which is 6 ticks after it was reset.
- Timer 1 is reset again before time t11, so again before it had expired and executed its callback function. Timer 1 is reset at time t9, so the time at which it will execute its callback function is re-calculated to be t15, which is 6 ticks after it was last reset.
- Timer 1 is not reset again, so it expires at time t15, and its callback function is executed accordingly.

The xTimerReset() API Function

A timer is reset using the xTimerReset() API function.

xTimerReset() can also be used to start a timer that is in the Dormant state.

Note: Never call `xTimerReset()` from an interrupt service routine. The interrupt-safe version `xTimerResetFromISR()` should be used in its place.

```
 BaseType_t xTimerReset( TimerHandle_t xTimer, TickType_t xTicksToWait );
```

Listing 84. The `xTimerReset()` API function prototype

Table 32. `xTimerReset()` parameters and return value

Parameter Name/ Returned Value	Description
<code>xTimer</code>	The handle of the software timer being reset or started. The handle will have been returned from the call to <code>xTimerCreate()</code> used to create the software timer.
<code>xTicksToWait</code>	<p><code>xTimerChangePeriod()</code> uses the timer command queue to send the 'reset' command to the daemon task. <code>xTicksToWait</code> specifies the maximum amount of time the calling task should remain in the Blocked state to wait for space to become available on the timer command queue, should the queue already be full.</p> <p><code>xTimerReset()</code> will return immediately if <code>xTicksToWait</code> is zero and the timer command queue is already full.</p> <p>If <code>INCLUDE_vTaskSuspend</code> is set to 1 in <code>FreeRTOSConfig.h</code> then setting <code>xTicksToWait</code> to <code>portMAX_DELAY</code> will result in the calling task remaining in the Blocked state indefinitely (without a timeout) to wait for space to become available in the timer command queue.</p>

Table 32. xTimerReset() parameters and return value

Parameter Name/ Returned Value	Description
Returned value	<p data-bbox="516 327 997 359">There are two possible return values:</p> <ol data-bbox="561 411 721 443" style="list-style-type: none"><li data-bbox="561 411 721 443">1. pdPASS <p data-bbox="561 495 1437 569">pdPASS will be returned only if data was successfully sent to the timer command queue.</p> <p data-bbox="561 621 1437 852">If a block time was specified (xTicksToWait was not zero), then it is possible the calling task was placed into the Blocked state to wait for space to become available in the timer command queue before the function returned, but data was successfully written to the timer command queue before the block time expired.</p> <ol data-bbox="561 905 737 936" style="list-style-type: none"><li data-bbox="561 905 737 936">2. pdFALSE <p data-bbox="561 989 1437 1115">pdFALSE will be returned if the 'reset' command could not be written to the timer command queue because the queue was already full.</p> <p data-bbox="561 1167 1437 1354">If a block time was specified (xTicksToWait was not zero) then the calling task will have been placed into the Blocked state to wait for the daemon task to make room in the queue, but the specified block time expired before that happened.</p>

Example 15. Resetting a software timer

This example simulates the behavior of the backlight on a cell phone. The backlight:

- Turns on when a key is pressed.
- Remains on provided further keys are pressed within a certain time period.
- Automatically turns off if no key presses are made within a certain time period.

A one-shot software timer is used to implement this behavior:

- The [simulated] backlight is turned on when a key is pressed, and turned off in the software timer's callback function.
- The software timer is reset each time a key is pressed.
- The time period during which a key must be pressed to prevent the backlight being turned off is therefore equal to the period of the software timer; if the software timer is not reset by a key press before the timer expires, then the timer's callback function executes, and the backlight is turned off.

The `xSimulatedBacklightOn` variable holds the backlight state. `xSimulatedBacklightOn` is set to `pdTRUE` to indicate the backlight is on, and `pdFALSE` to indicate the backlight is off.

The software timer callback function is shown in Listing 85.

```
static void prvBacklightTimerCallback( TimerHandle_t xTimer )
{
TickType_t xTimeNow = xTaskGetTickCount();

    /* The backlight timer expired, turn the backlight off. */
    xSimulatedBacklightOn = pdFALSE;

    /* Print the time at which the backlight was turned off. */
    vPrintStringAndNumber(
        "Timer expired, turning backlight OFF at time\t\t", xTimeNow );
}
```

Listing 85. The callback function for the one-shot timer used in Example 15

Example 15 creates a task to poll the keyboard¹. The task is shown in Listing 86, but for the reasons described in the next paragraph, Listing 86 is not intended to be representative of an optimal design.

Using FreeRTOS allows your application to be event driven. Event driven designs use processing time very efficiently, because processing time is only used if an event has occurred, and processing time is not wasted polling for events that have not occurred. Example 15 could not be made event driven because it is not practical to process keyboard interrupts when using the FreeRTOS Windows port, so the much less efficient polling

¹ Printing to the Windows console, and reading keys from the Windows console, both result in the execution of Windows system calls. Windows system calls, including use of the Windows console, disks, or TCP/IP stack, can adversely affect the behavior of the FreeRTOS Windows port, and should normally be avoided.

technique had to be used instead. If Listing 86 was an interrupt service routine, then `xTimerResetFromISR()` would be used in place of `xTimerReset()`.

```
static void vKeyHitTask( void *pvParameters )
{
const TickType_t xShortDelay = pdMS_TO_TICKS( 50 );
TickType_t xTimeNow;

    vPrintString( "Press a key to turn the backlight on.\r\n" );

    /* Ideally an application would be event driven, and use an interrupt to process key
presses. It is not practical to use keyboard interrupts when using the FreeRTOS Windows
port, so this task is used to poll for a key press. */
    for( ;; )
    {
        /* Has a key been pressed? */
        if( _kbhit() != 0 )
        {
            /* A key has been pressed. Record the time. */
            xTimeNow = xTaskGetTickCount();

            if( xSimulatedBacklightOn == pdFALSE )
            {
                /* The backlight was off, so turn it on and print the time at which it was
turned on. */
                xSimulatedBacklightOn = pdTRUE;
                vPrintStringAndNumber(
                    "Key pressed, turning backlight ON at time\t\t", xTimeNow );
            }
            else
            {
                /* The backlight was already on, so print a message to say the timer is about to
be reset and the time at which it was reset. */
                vPrintStringAndNumber(
                    "Key pressed, resetting software timer at time\t\t", xTimeNow );
            }

            /* Reset the software timer. If the backlight was previously off, then this call
will start the timer. If the backlight was previously on, then this call will
restart the timer. A real application may read key presses in an interrupt. If
this function was an interrupt service routine then xTimerResetFromISR() must be
used instead of xTimerReset(). */
            xTimerReset( xBacklightTimer, xShortDelay );

            /* Read and discard the key that was pressed - it is not required by this simple
example. */
            ( void ) _getch();
        }
    }
}
```

Listing 86. The task used to reset the software timer in Example 15

The output produced when Example 15 is executed is shown in Figure 47. With reference to Figure 47:

- The first key press occurred when the tick count was 812. At that time the backlight was turned on, and the one-shot timer was started.
- Further key presses occurred when the tick count was 1813, 3114, 4015 and 5016. All of these key presses resulted in the timer being reset before the timer had expired.

- The timer expired when the tick count was 10016. At that time the backlight was turned off.

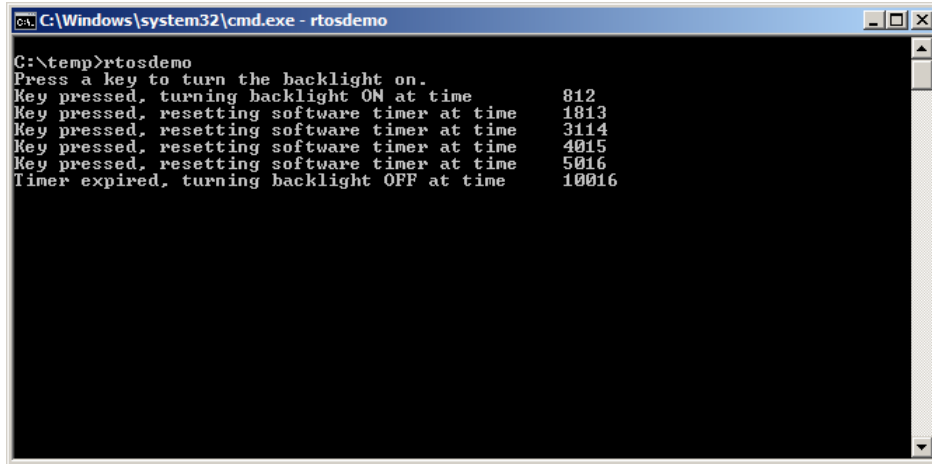

```
C:\Windows\system32\cmd.exe - rtosdemo
C:\temp>rtosdemo
Press a key to turn the backlight on.
Key pressed, turning backlight ON at time      812
Key pressed, resetting software timer at time 1813
Key pressed, resetting software timer at time 3114
Key pressed, resetting software timer at time 4015
Key pressed, resetting software timer at time 5016
Timer expired, turning backlight OFF at time 10016
```

Figure 47 The output produced when Example 15 is executed

It can be seen in Figure 47 that the timer had a period of 5000 ticks; the backlight was turned off exactly 5000 ticks after a key was last pressed, so 5000 ticks after the timer was last reset.

Chapter 6

Interrupt Management

6.1 Chapter Introduction and Scope

Events

Embedded real-time systems have to take actions in response to events that originate from the environment. For example, a packet arriving on an Ethernet peripheral (the event) might require passing to a TCP/IP stack for processing (the action). Non-trivial systems will have to service events that originate from multiple sources, all of which will have different processing overhead and response time requirements. In each case, a judgment has to be made as to the best event processing implementation strategy:

1. How should the event be detected? Interrupts are normally used, but inputs can also be polled.
2. When interrupts are used, how much processing should be performed inside the interrupt service routine (ISR), and how much outside? It is normally desirable to keep each ISR as short as possible.
3. How events are communicated to the main (non-ISR) code, and how can this code be structured to best accommodate processing of potentially asynchronous occurrences?

FreeRTOS does not impose any specific event processing strategy on the application designer, but does provide features that allow the chosen strategy to be implemented in a simple and maintainable way.

It is important to draw a distinction between the priority of a task, and the priority of an interrupt:

- A task is a software feature that is unrelated to the hardware on which FreeRTOS is running. The priority of a task is assigned in software by the application writer, and a software algorithm (the scheduler) decides which task will be in the Running state.
- Although written in software, an interrupt service routine is a hardware feature because the hardware controls which interrupt service routine will run, and when it will run. Tasks will only run when there are no ISRs running, so the lowest priority interrupt will interrupt the highest priority task, and there is no way for a task to pre-empt an ISR.

All architectures on which FreeRTOS will run are capable of processing interrupts, but details relating to interrupt entry, and interrupt priority assignment, vary between architectures.

Scope

This chapter aims to give readers a good understanding of:

- Which FreeRTOS API functions can be used from within an interrupt service routine.
- Methods of deferring interrupt processing to a task.
- How to create and use binary semaphores and counting semaphores.
- The differences between binary and counting semaphores.
- How to use a queue to pass data into and out of an interrupt service routine.
- The interrupt nesting model available with some FreeRTOS ports.

6.2 Using the FreeRTOS API from an ISR

The Interrupt Safe API

Often it is necessary to use the functionality provided by a FreeRTOS API function from an interrupt service routine (ISR), but many FreeRTOS API functions perform actions that are not valid inside an ISR—the most notable of which is placing the task that called the API function into the Blocked state; if an API function is called from an ISR, then it is not being called from a task, so there is no calling task that can be placed into the Blocked state. FreeRTOS solves this problem by providing two versions of some API functions; one version for use from tasks, and one version for use from ISRs. Functions intended for use from ISRs have “FromISR” appended to their name.

Note: Never call a FreeRTOS API function that does not have “FromISR” in its name from an ISR.

The Benefits of Using a Separate Interrupt Safe API

Having a separate API for use in interrupts allows task code to be more efficient, ISR code to be more efficient, and interrupt entry to be simpler. To see why, consider the alternative solution, which would have been to provide a single version of each API function that could be called from both a task and an ISR. If the same version of an API function could be called from both a task and an ISR then:

- The API functions would need additional logic to determine if they had been called from a task or an ISR. The additional logic would introduce new paths through the function, making the functions longer, more complex, and harder to test.
- Some API function parameters would be obsolete when the function was called from a task, while others would be obsolete when the function was called from an ISR.
- Each FreeRTOS port would need to provide a mechanism for determining the execution context (task or ISR).
- Architectures on which it is not easy to determine the execution context (task or ISR) would require additional, wasteful, more complex to use, and non-standard interrupt entry code that allowed the execution context to be provided by software.

The Disadvantages of Using a Separate Interrupt Safe API

Having two versions of some API functions allows both tasks and ISRs to be more efficient, but introduces a new problem; sometimes it is necessary to call a function that is not part of the FreeRTOS API, but makes use of the FreeRTOS API, from both a task and an ISR.

This is normally only a problem when integrating third party code, as that is the only time when the software's design is out of the control of the application writer. If this does become an issue then the problem can be overcome using one of the following techniques:

1. Defer interrupt processing to a task¹, so the API function is only ever called from the context of a task.
2. If you are using a FreeRTOS port that supports interrupt nesting, then use the version of the API function that ends in "FromISR", as that version can be called from tasks and ISRs (the reverse is not true, API functions that do not end in "FromISR" must not be called from an ISR).
3. Third party code normally includes an RTOS abstraction layer that can be implemented to test the context from which the function is being called (task or interrupt), and then call the API function that is appropriate for the context.

The xHigherPriorityTaskWoken Parameter

This section introduces the concept of the xHigherPriorityTaskWoken parameter. Do not be concerned if you do not fully understand this section yet, as practical examples are provided in following sections.

If a context switch is performed by an interrupt, then the task running when the interrupt exits might be different to the task that was running when the interrupt was entered—the interrupt will have interrupted one task, but returned to a different task.

Some FreeRTOS API functions can move a task from the Blocked state to the Ready state. This has already been seen with functions such as xQueueSendToBack(), which will unblock a task if there was a task waiting in the Blocked state for data to become available on the subject queue.

¹ Deferred interrupt processing is covered in the next section of this book.

If the priority of a task that is unblocked by a FreeRTOS API function is higher than the priority of the task in the Running state then, in accordance with the FreeRTOS scheduling policy, a switch to the higher priority task should occur. When the switch to the higher priority task actually occurs is dependent on the context from which the API function is called:

- If the API function was called from a task

If `configUSE_PREEMPTION` is set to 1 in `FreeRTOSConfig.h` then the switch to the higher priority task occurs automatically within the API function—so before the API function has exited. This has already been seen in Figure 43, where writing to the timer command queue resulted in a switch to the RTOS daemon task before the function that wrote to the command queue had exited.

- If the API function was called from an interrupt

A switch to a higher priority task will not occur automatically inside an interrupt. Instead, a variable is set to inform the application writer that a context switch should be performed. Interrupt safe API functions (those that end in “FromISR”) have a pointer parameter called `pxHigherPriorityTaskWoken` that is used for this purpose.

If a context switch should be performed, then the interrupt safe API function will set `*pxHigherPriorityTaskWoken` to `pdTRUE`. To be able to detect this has happened, the variable pointed to by `pxHigherPriorityTaskWoken` must be initialized to `pdFALSE` before it is used for the first time.

If the application writer opts not to request a context switch from the ISR, then the higher priority task will remain in the Ready state until the next time the scheduler runs—which in the worst case will be during the next tick interrupt.

FreeRTOS API functions can only set `*pxHighPriorityTaskWoken` to `pdTRUE`. If an ISR calls more than one FreeRTOS API function, then the same variable can be passed as the `pxHigherPriorityTaskWoken` parameter in each API function call, and the variable only needs to be initialized to `pdFALSE` before it is used for the first time.

There are several reasons why context switches do not occur automatically inside the interrupt safe version of an API function:

1. Avoiding unnecessary context switches

An interrupt may execute more than once before it is necessary for a task to perform any processing. For example, consider a scenario where a task processes a string that was received by an interrupt driven UART; it would be wasteful for the UART ISR to switch to the task each time a character was received because the task would only have processing to perform after the complete string had been received.

2. Control over the execution sequence

Interrupts can occur sporadically, and at unpredictable times. Expert FreeRTOS users may want to temporarily avoid an unpredictable switch to a different task at specific points in their application—although this can also be achieved using the FreeRTOS scheduler locking mechanism.

3. Portability

It is the simplest mechanism that can be used across all FreeRTOS ports.

4. Efficiency

Ports that target smaller processor architectures only allow a context switch to be requested at the very end of an ISR, and removing that restriction would require additional and more complex code. It also allows more than one call to a FreeRTOS API function within the same ISR without generating more than one request for a context switch within the same ISR.

5. Execution in the RTOS tick interrupt

As will be seen later in this book, it is possible to add application code into the RTOS tick interrupt. The result of attempting a context switch inside the tick interrupt is dependent on the FreeRTOS port in use. At best, it will result in an unnecessary call to the scheduler.

Use of the `pxHigherPriorityTaskWoken` parameter is optional. If it is not required, then set `pxHigherPriorityTaskWoken` to `NULL`.

The `portYIELD_FROM_ISR()` and `portEND_SWITCHING_ISR()` Macros

This section introduces the macros that are used to request a context switch from an ISR. Do not be concerned if you do not fully understand this section yet, as practical examples are provided in following sections.

taskYIELD() is a macro that can be called in a task to request a context switch. portYIELD_FROM_ISR() and portEND_SWITCHING_ISR() are both interrupt safe versions of taskYIELD(). portYIELD_FROM_ISR() and portEND_SWITCHING_ISR() are both used in the same way, and do the same thing¹. Some FreeRTOS ports only provide one of the two macros. Newer FreeRTOS ports provide both macros. The examples in this book use portYIELD_FROM_ISR().

```
portEND_SWITCHING_ISR( xHigherPriorityTaskWoken );
```

Listing 87. The portEND_SWITCHING_ISR() macros

```
portYIELD_FROM_ISR( xHigherPriorityTaskWoken );
```

Listing 88. The portYIELD_FROM_ISR() macros

The xHigherPriorityTaskWoken parameter passed out of an interrupt safe API function can be used directly as the parameter in a call to portYIELD_FROM_ISR().

If the portYIELD_FROM_ISR() xHigherPriorityTaskWoken parameter is pdFALSE (zero), then a context switch is not requested, and the macro has no effect. If the portYIELD_FROM_ISR() xHigherPriorityTaskWoken parameter is not pdFALSE, then a context switch is requested, and the task in the Running state might change. The interrupt will always return to the task in the Running state, even if the task in the Running state changed while the interrupt was executing.

Most FreeRTOS ports allow portYIELD_FROM_ISR() to be called anywhere within an ISR. A few FreeRTOS ports (predominantly those for smaller architectures), only allow portYIELD_FROM_ISR() to be called at the very end of an ISR.

¹ Historically, portEND_SWITCHING_ISR() was the name used in FreeRTOS ports that required interrupt handlers to use an assembly code wrapper, and portYIELD_FROM_ISR() was the name used in FreeRTOS ports that allowed the entire interrupt handler to be written in C.

6.3 Deferred Interrupt Processing

It is normally considered best practice to keep ISRs as short as possible. Reasons for this include:

- Even if tasks have been assigned a very high priority, they will only run if no interrupts are being serviced by the hardware.
- ISRs can disrupt (add 'jitter' to) both the start time, and the execution time, of a task.
- Depending on the architecture on which FreeRTOS is running, it might not be possible to accept any new interrupts, or at least a subset of new interrupts, while an ISR is executing.
- The application writer needs to consider the consequences of, and guard against, resources such as variables, peripherals, and memory buffers being accessed by a task and an ISR at the same time.
- Some FreeRTOS ports allow interrupts to nest, but interrupt nesting can increase complexity and reduce predictability. The shorter an interrupt is, the less likely it is to nest.

An interrupt service routine must record the cause of the interrupt, and clear the interrupt. Any other processing necessitated by the interrupt can often be performed in a task, allowing the interrupt service routine to exit as quickly as is practical. This is called 'deferred interrupt processing', because the processing necessitated by the interrupt is 'deferred' from the ISR to a task.

Deferring interrupt processing to a task also allows the application writer to prioritize the processing relative to other tasks in the application, and use all the FreeRTOS API functions.

If the priority of the task to which interrupt processing is deferred is above the priority of any other task, then the processing will be performed immediately, just as if the processing had been performed in the ISR itself. This scenario is shown in Figure 48, in which Task 1 is a normal application task, and Task 2 is the task to which interrupt processing is deferred.

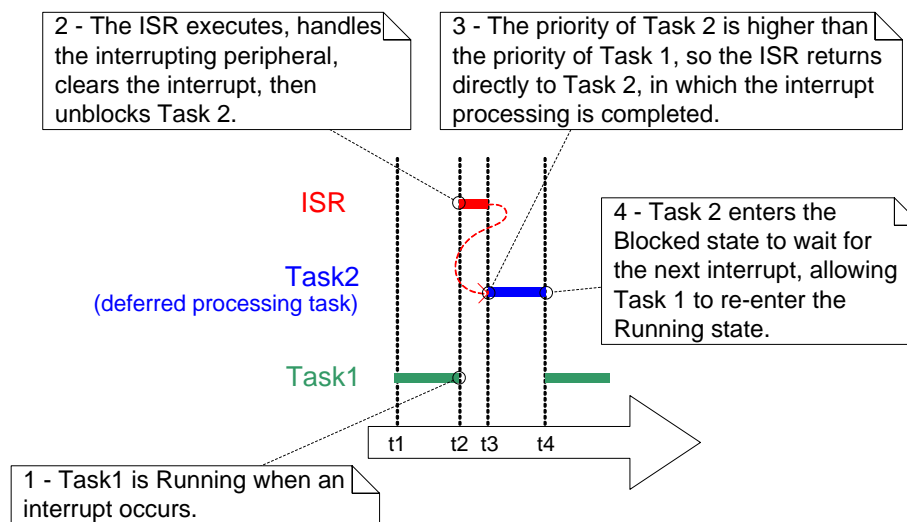

Figure 48 Completing interrupt processing in a high priority task

In Figure 48, interrupt processing starts at time t2, and effectively ends at time t4, but only the period between times t2 and t3 is spent in the ISR. If deferred interrupt processing had not been used then the entire period between times t2 and t4 would have been spent in the ISR.

There is no absolute rule as to when it is best to perform all processing necessitated by an interrupt in the ISR, and when it is best to defer part of the processing to a task. Deferring processing to a task is most useful when:

- The processing necessitated by the interrupt is not trivial. For example, if the interrupt is just storing the result of an analog to digital conversion, then it is almost certain this is best performed inside the ISR, but if result of the conversion must also be passed through a software filter, then it may be best to execute the filter in a task.
- It is convenient for the interrupt processing to perform an action that cannot be performed inside an ISR, such as write to a console, or allocate memory.
- The interrupt processing is not deterministic—meaning it is not known in advance how long the processing will take.

The following sections describe and demonstrate the concepts introduced in this chapter so far, including FreeRTOS features that can be used to implement deferred interrupt processing.

6.4 Binary Semaphores Used for Synchronization

The interrupt safe version of the Binary Semaphore API can be used to unblock a task each time a particular interrupt occurs, effectively synchronizing the task with the interrupt. This allows the majority of the interrupt event processing to be implemented within the synchronized task, with only a very fast and short portion remaining directly in the ISR. As described in the previous section, the binary semaphore is used to ‘defer’ interrupt processing to a task¹.

As previously demonstrated in Figure 48, if the interrupt processing is particularly time critical, then the priority of the deferred processing task can be set to ensure the task always pre-empts the other tasks in the system. The ISR can then be implemented to include a call to `portYIELD_FROM_ISR()`, ensuring the ISR returns directly to the task to which interrupt processing is being deferred. This has the effect of ensuring the entire event processing executes contiguously (without a break) in time, just as if it had all been implemented within the ISR itself. Figure 49 repeats the scenario shown in Figure 48, but with the text updated to describe how the execution of the deferred processing task can be controlled using a semaphore.

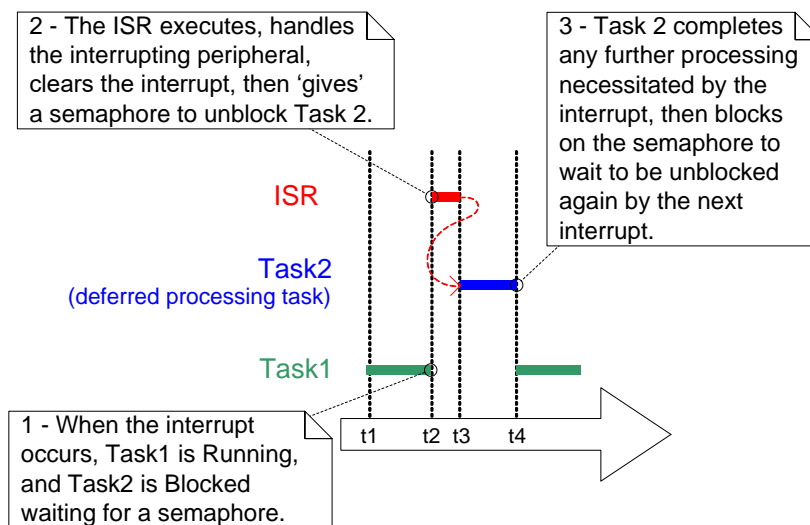

Figure 49. Using a binary semaphore to implement deferred interrupt processing

The deferred processing task uses a blocking ‘take’ call to a semaphore as a means of entering the Blocked state to wait for the event to occur. When the event occurs, the ISR uses

¹ It is more efficient to unblock a task from an interrupt using a direct to task notification than it is using a binary semaphore. Direct to task notifications are not covered until Chapter 9, Task Notifications.

a 'give' operation on the same semaphore to unblock the task so that the required event processing can proceed.

'Taking a semaphore' and 'giving a semaphore' are concepts that have different meanings depending on their usage scenario. In this interrupt synchronization scenario, the binary semaphore can be considered conceptually as a queue with a length of one. The queue can contain a maximum of one item at any time, so is always either empty or full (hence, binary). By calling `xSemaphoreTake()`, the task to which interrupt processing is deferred effectively attempts to read from the queue with a block time, causing the task to enter the Blocked state if the queue is empty. When the event occurs, the ISR uses the `xSemaphoreGiveFromISR()` function to place a token (the semaphore) into the queue, making the queue full. This causes the task to exit the Blocked state and remove the token, leaving the queue empty once more. When the task has completed its processing, it once more attempts to read from the queue and, finding the queue empty, re-enters the Blocked state to wait for the next event. This sequence is demonstrated in Figure 50.

Figure 50 shows the interrupt 'giving' the semaphore, even though it has not first 'taken' it, and the task 'taking' the semaphore, but never giving it back. This is why the scenario is described as being conceptually similar to writing to and reading from a queue. It often causes confusion as it does not follow the same rules as other semaphore usage scenarios, where a task that takes a semaphore must always give it back—such as the scenarios described in Chapter 7, Resource Management.

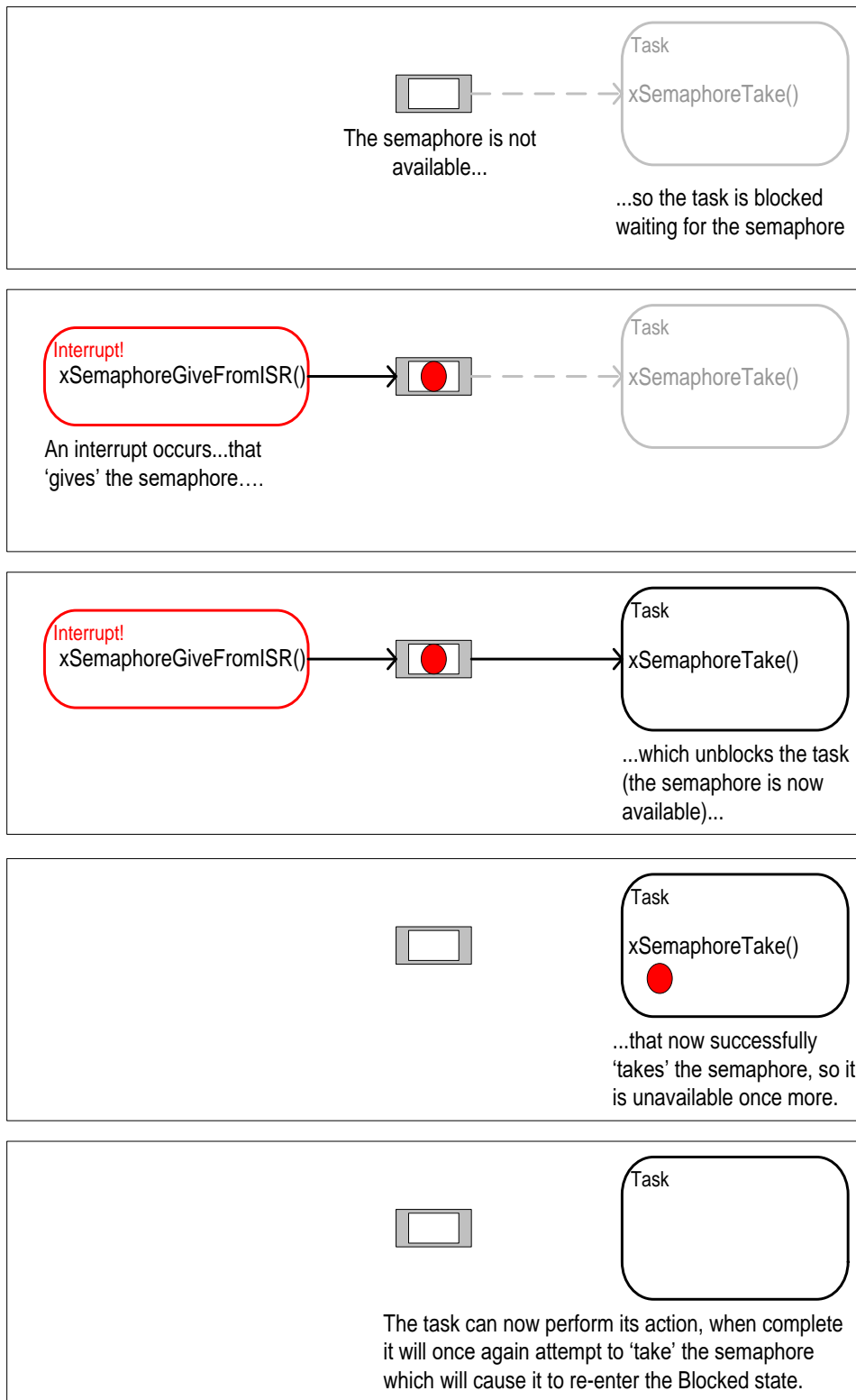

Figure 50. Using a binary semaphore to synchronize a task with an interrupt

The xSemaphoreCreateBinary() API Function

FreeRTOS V9.0.0 also includes the xSemaphoreCreateBinaryStatic() function, which allocates the memory required to create a binary semaphore statically at compile time: Handles to all the various types of FreeRTOS semaphore are stored in a variable of type SemaphoreHandle_t.

Before a semaphore can be used, it must be created. To create a binary semaphore, use the xSemaphoreCreateBinary() API function¹.

```
SemaphoreHandle_t xSemaphoreCreateBinary( void );
```

Listing 89. The xSemaphoreCreateBinary() API function prototype

Table 33. xSemaphoreCreateBinary() Return Value

Parameter Name	Description
Returned value	If NULL is returned, then the semaphore cannot be created because there is insufficient heap memory available for FreeRTOS to allocate the semaphore data structures. A non-NULL value being returned indicates that the semaphore has been created successfully. The returned value should be stored as the handle to the created semaphore.

The xSemaphoreTake() API Function

‘Taking’ a semaphore means to ‘obtain’ or ‘receive’ the semaphore. The semaphore can be taken only if it is available.

All the various types of FreeRTOS semaphore, except recursive mutexes, can be ‘taken’ using the xSemaphoreTake() function.

xSemaphoreTake() must not be used from an interrupt service routine.

¹ Some Semaphore API functions are actually macros, not functions. For simplicity, they are all referred to as functions throughout this book.

```
BaseType_t xSemaphoreTake( SemaphoreHandle_t xSemaphore, TickType_t xTicksToWait );
```

Listing 90. The xSemaphoreTake() API function prototype

Table 34. xSemaphoreTake() parameters and return value

Parameter Name/ Returned Value	Description
xSemaphore	<p>The semaphore being 'taken'.</p> <p>A semaphore is referenced by a variable of type SemaphoreHandle_t. It must be explicitly created before it can be used.</p>
xTicksToWait	<p>The maximum amount of time the task should remain in the Blocked state to wait for the semaphore if it is not already available.</p> <p>If xTicksToWait is zero, then xSemaphoreTake() will return immediately if the semaphore is not available.</p> <p>The block time is specified in tick periods, so the absolute time it represents is dependent on the tick frequency. The macro pdMS_TO_TICKS() can be used to convert a time specified in milliseconds to a time specified in ticks.</p> <p>Setting xTicksToWait to portMAX_DELAY will cause the task to wait indefinitely (without a timeout) if INCLUDE_vTaskSuspend is set to 1 in FreeRTOSConfig.h.</p>

Table 34. xSemaphoreTake() parameters and return value

Parameter Name/ Returned Value	Description
Returned value	<p>There are two possible return values:</p> <ol style="list-style-type: none">1. pdPASS <p>pdPASS is returned only if the call to xSemaphoreTake() was successful in obtaining the semaphore.</p> <p>If a block time was specified (xTicksToWait was not zero), then it is possible that the calling task was placed into the Blocked state to wait for the semaphore if it was not immediately available, but the semaphore became available before the block time expired.</p> <ol style="list-style-type: none">2. pdFALSE <p>The semaphore is not available.</p> <p>If a block time was specified (xTicksToWait was not zero), then the calling task will have been placed into the Blocked state to wait for the semaphore to become available, but the block time expired before this happened.</p>

The xSemaphoreGiveFromISR() API Function

Binary and counting semaphores¹ can be 'given' using the xSemaphoreGiveFromISR() function.

xSemaphoreGiveFromISR() is the interrupt safe version of xSemaphoreGive(), so has the pxHigherPriorityTaskWoken parameter that was described at the start of this chapter.

```
 BaseType_t xSemaphoreGiveFromISR( SemaphoreHandle_t xSemaphore,  
                                 BaseType_t *pxHigherPriorityTaskWoken );
```

Listing 91. The xSemaphoreGiveFromISR() API function prototype

¹ Counting semaphores are described in a later section of this book.

Table 35. xSemaphoreGiveFromISR() parameters and return value

Parameter Name/ Returned Value	Description
xSemaphore	<p>The semaphore being 'given'.</p> <p>A semaphore is referenced by a variable of type SemaphoreHandle_t, and must be explicitly created before being used.</p>
pxHigherPriorityTaskWoken	<p>It is possible that a single semaphore will have one or more tasks blocked on it waiting for the semaphore to become available. Calling xSemaphoreGiveFromISR() can make the semaphore available, and so cause a task that was waiting for the semaphore to leave the Blocked state. If calling xSemaphoreGiveFromISR() causes a task to leave the Blocked state, and the unblocked task has a priority higher than the currently executing task (the task that was interrupted), then, internally, xSemaphoreGiveFromISR() will set *pxHigherPriorityTaskWoken to pdTRUE.</p> <p>If xSemaphoreGiveFromISR() sets this value to pdTRUE, then normally a context switch should be performed before the interrupt is exited. This will ensure that the interrupt returns directly to the highest priority Ready state task.</p>
Returned value	<p>There are two possible return values:</p> <ol style="list-style-type: none">1. pdPASS <p>pdPASS will be returned only if the call to xSemaphoreGiveFromISR() is successful.</p> <ol style="list-style-type: none">2. pdFAIL <p>If a semaphore is already available, it cannot be given, and xSemaphoreGiveFromISR() will return pdFAIL.</p>

Example 16. Using a binary semaphore to synchronize a task with an interrupt

This example uses a binary semaphore to unblock a task from an interrupt service routine—effectively synchronizing the task with the interrupt.

A simple periodic task is used to generate a software interrupt every 500 milliseconds. A software interrupt is used for convenience because of the complexity of hooking into a real interrupt in some target environments. Listing 92 shows the implementation of the periodic task. Note that the task prints out a string both before and after the interrupt is generated. This allows the sequence of execution to be observed in the output produced when the example is executed.

```
/* The number of the software interrupt used in this example. The code shown is from
the Windows project, where numbers 0 to 2 are used by the FreeRTOS Windows port
itself, so 3 is the first number available to the application. */
#define mainINTERRUPT_NUMBER    3

static void vPeriodicTask( void *pvParameters )
{
const TickType_t xDelay500ms = pdMS_TO_TICKS( 500UL );

    /* As per most tasks, this task is implemented within an infinite loop. */
    for( ;; )
    {
        /* Block until it is time to generate the software interrupt again. */
        vTaskDelay( xDelay500ms );

        /* Generate the interrupt, printing a message both before and after
        the interrupt has been generated, so the sequence of execution is evident
        from the output.

        The syntax used to generate a software interrupt is dependent on the
        FreeRTOS port being used. The syntax used below can only be used with
        the FreeRTOS Windows port, in which such interrupts are only simulated. */
        vPrintString( "Periodic task - About to generate an interrupt.\r\n" );
        vPortGenerateSimulatedInterrupt( mainINTERRUPT_NUMBER );
        vPrintString( "Periodic task - Interrupt generated.\r\n\r\n\r\n" );
    }
}
```

Listing 92. Implementation of the task that periodically generates a software interrupt in Example 16

Listing 93 shows the implementation of the task to which the interrupt processing is deferred—the task that is synchronized with the software interrupt through the use of a binary semaphore. Again, a string is printed out on each iteration of the task, so the sequence in which the task and the interrupt execute is evident from the output produced when the example is executed.

It should be noted that, while the code shown in Listing 93 is adequate for Example 16, where interrupts are generated by software, it is not adequate for scenarios where interrupts are generated by hardware peripherals. A following sub-section describes how the structure of the code needs to be changed to make it suitable for use with hardware generated interrupts.

```
static void vHandlerTask( void *pvParameters )
{
    /* As per most tasks, this task is implemented within an infinite loop. */
    for( ;; )
    {
        /* Use the semaphore to wait for the event. The semaphore was created
        before the scheduler was started, so before this task ran for the first
        time. The task blocks indefinitely, meaning this function call will only
        return once the semaphore has been successfully obtained - so there is
        no need to check the value returned by xSemaphoreTake(). */
        xSemaphoreTake( xBinarySemaphore, portMAX_DELAY );

        /* To get here the event must have occurred. Process the event (in this
        case, just print out a message). */
        vPrintString( "Handler task - Processing event.\r\n" );
    }
}
```

Listing 93. The implementation of the task to which the interrupt processing is deferred (the task that synchronizes with the interrupt) in Example 16

Listing 94 shows the ISR. This does very little other than ‘give’ the semaphore to unblock the task to which interrupt processing is deferred.

Note how the `xHigherPriorityTaskWoken` variable is used. It is set to `pdFALSE` before calling `xSemaphoreGiveFromISR()`, then used as the parameter when `portYIELD_FROM_ISR()` is called. A context switch will be requested inside the `portYIELD_FROM_ISR()` macro if `xHigherPriorityTaskWoken` equals `pdTRUE`.

The prototype of the ISR, and the macro called to force a context switch, are both correct for the FreeRTOS Windows port, and may be different for other FreeRTOS ports. Refer to the port specific documentation pages on the FreeRTOS.org website, and the examples provided in the FreeRTOS download, to find the syntax required for the port you are using.

Unlike most architectures on which FreeRTOS runs, the FreeRTOS Windows port requires an ISR to return a value. The implementation of the `portYIELD_FROM_ISR()` macro provided with the Windows port includes the return statement, so Listing 94 does not show a value being returned explicitly.

```

static uint32_t ulExampleInterruptHandler( void )
{
BaseType_t xHigherPriorityTaskWoken;

    /* The xHigherPriorityTaskWoken parameter must be initialized to pdFALSE as
    it will get set to pdTRUE inside the interrupt safe API function if a
    context switch is required. */
    xHigherPriorityTaskWoken = pdFALSE;

    /* 'Give' the semaphore to unblock the task, passing in the address of
    xHigherPriorityTaskWoken as the interrupt safe API function's
    pxHigherPriorityTaskWoken parameter. */
    xSemaphoreGiveFromISR( xBinarySemaphore, &xHigherPriorityTaskWoken );

    /* Pass the xHigherPriorityTaskWoken value into portYIELD_FROM_ISR(). If
    xHigherPriorityTaskWoken was set to pdTRUE inside xSemaphoreGiveFromISR()
    then calling portYIELD_FROM_ISR() will request a context switch. If
    xHigherPriorityTaskWoken is still pdFALSE then calling
    portYIELD_FROM_ISR() will have no effect. Unlike most FreeRTOS ports, the
    Windows port requires the ISR to return a value - the return statement
    is inside the Windows version of portYIELD_FROM_ISR(). */
    portYIELD_FROM_ISR( xHigherPriorityTaskWoken );
}

```

Listing 94. The ISR for the software interrupt used in Example 16

The main() function creates the binary semaphore, creates the tasks, installs the interrupt handler, and starts the scheduler. The implementation is shown in Listing 95.

The syntax of the function called to install an interrupt handler is specific to the FreeRTOS Windows port, and may be different for other FreeRTOS ports. Refer to the port specific documentation pages on the FreeRTOS.org website, and the examples provided in the FreeRTOS download, to find the syntax required for the port you are using.

```
int main( void )
{
    /* Before a semaphore is used it must be explicitly created. In this example
    a binary semaphore is created. */
    xBinarySemaphore = xSemaphoreCreateBinary();

    /* Check the semaphore was created successfully. */
    if( xBinarySemaphore != NULL )
    {
        /* Create the 'handler' task, which is the task to which interrupt
        processing is deferred. This is the task that will be synchronized with
        the interrupt. The handler task is created with a high priority to ensure
        it runs immediately after the interrupt exits. In this case a priority of
        3 is chosen. */
        xTaskCreate( vHandlerTask, "Handler", 1000, NULL, 3, NULL );

        /* Create the task that will periodically generate a software interrupt.
        This is created with a priority below the handler task to ensure it will
        get preempted each time the handler task exits the Blocked state. */
        xTaskCreate( vPeriodicTask, "Periodic", 1000, NULL, 1, NULL );

        /* Install the handler for the software interrupt. The syntax necessary
        to do this is dependent on the FreeRTOS port being used. The syntax
        shown here can only be used with the FreeRTOS windows port, where such
        interrupts are only simulated. */
        vPortSetInterruptHandler( mainINTERRUPT_NUMBER, ulExampleInterruptHandler );

        /* Start the scheduler so the created tasks start executing. */
        vTaskStartScheduler();
    }

    /* As normal, the following line should never be reached. */
    for( ;; );
}
```

Listing 95. The implementation of main() for Example 16

Example 16 produces the output shown in Figure 51. As expected, vHandlerTask() enters the Running state as soon as the interrupt is generated, so the output from the task splits the output produced by the periodic task. Further explanation is provided in Figure 52.

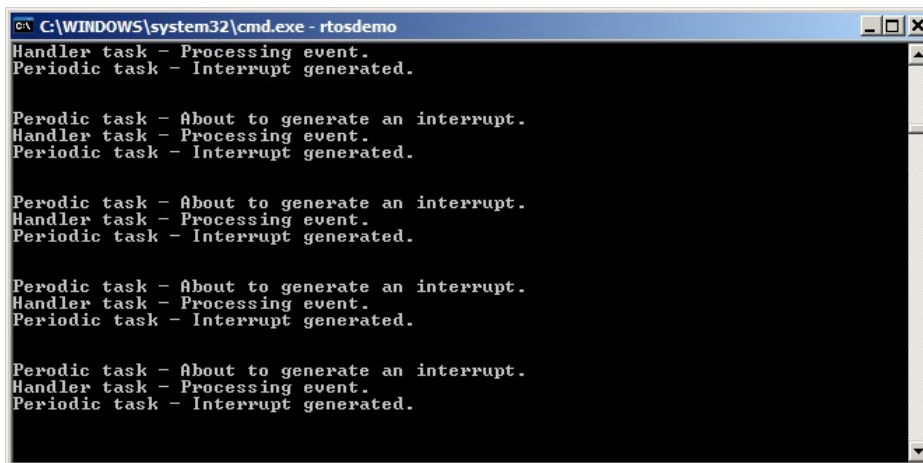

```
C:\WINDOWS\system32\cmd.exe - rtosdemo
Handler task - Processing event.
Periodic task - Interrupt generated.

Periodic task - About to generate an interrupt.
Handler task - Processing event.
Periodic task - Interrupt generated.

Periodic task - About to generate an interrupt.
Handler task - Processing event.
Periodic task - Interrupt generated.

Periodic task - About to generate an interrupt.
Handler task - Processing event.
Periodic task - Interrupt generated.

Periodic task - About to generate an interrupt.
Handler task - Processing event.
Periodic task - Interrupt generated.
```

Figure 51. The output produced when Example 16 is executed

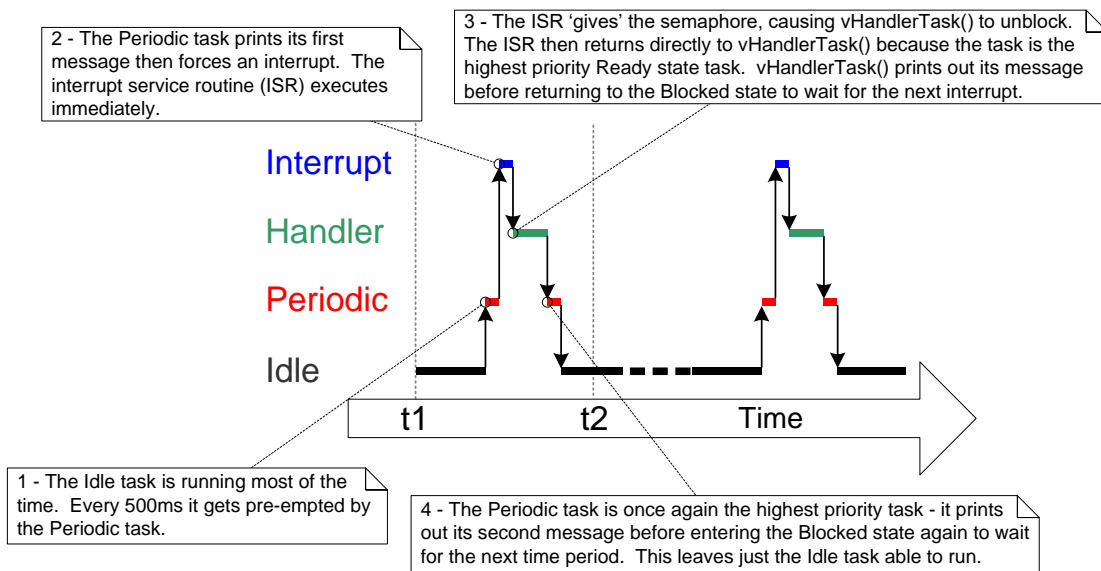

Figure 52. The sequence of execution when Example 16 is executed

Improving the Implementation of the Task Used in Example 16

Example 16 used a binary semaphore to synchronize a task with an interrupt. The execution sequence was as follows:

1. The interrupt occurred.
2. The ISR executed and 'gave' the semaphore to unblock the task.
3. The task executed immediately after the ISR, and 'took' the semaphore.
4. The task processed the event, then attempted to 'take' the semaphore again—entering the Blocked state because the semaphore was not yet available (another interrupt had not yet occurred).

The structure of the task used in Example 16 is adequate only if interrupts occur at a relatively low frequency. To understand why, consider what would happen if a second, and then a third, interrupt had occurred before the task had completed its processing of the first interrupt:

- When the second ISR executed the semaphore would be empty, so the ISR would give the semaphore, and the task would process the second event immediately after it had completed processing the first event. That scenario is shown in Figure 53.

- When the third ISR executed, the semaphore would already be available, preventing the ISR giving the semaphore again, so the task would not know the third event had occurred. That scenario is shown in Figure 54.

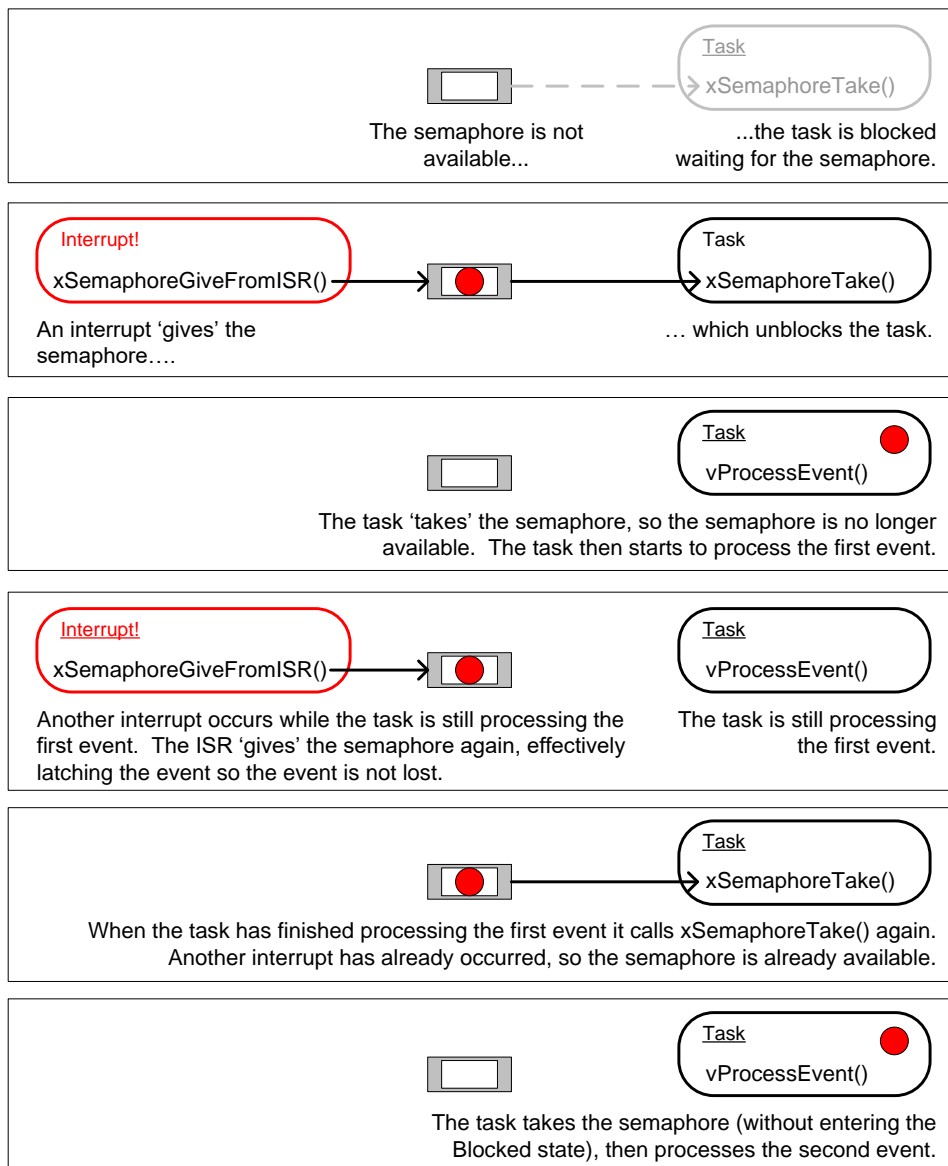

Figure 53. The scenario when one interrupt occurs before the task has finished processing the first event

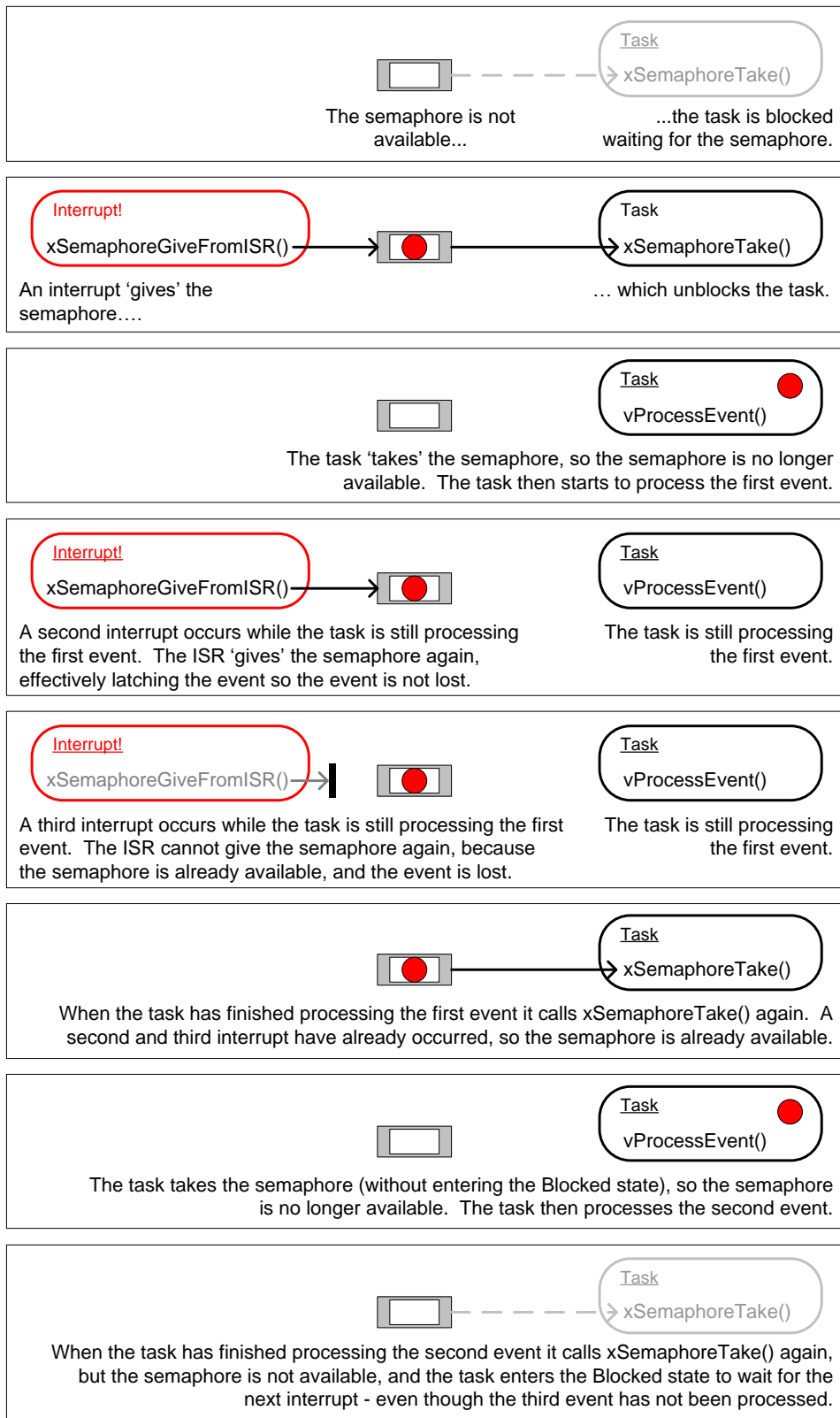

Figure 54 The scenario when two interrupts occur before the task has finished processing the first event

The deferred interrupt handling task used in Example 16, and shown in Listing 93, is structured so that it only processes one event between each call to `xSemaphoreTake()`. That was adequate for Example 16, because the interrupts that generated the events were triggered by software, and occurred at a predictable time. In real applications, interrupts are generated by hardware, and occur at unpredictable times. Therefore, to minimize the chance of an interrupt being missed, the deferred interrupt handling task must be structured so that it processes all the events that are already available between each call to `xSemaphoreTake()`¹. This is demonstrated by Listing 96, which shows how a deferred interrupt handler for a UART could be structured. In Listing 96, it is assumed the UART generates a receive interrupt each time a character is received, and that the UART places received characters into a hardware FIFO (a hardware buffer).

The deferred interrupt handling task used in Example 16 had one other weakness; it did not use a time out when it called `xSemaphoreTake()`. Instead, the task passed `portMAX_DELAY` as the `xSemaphoreTake()` `xTicksToWait` parameter, which results in the task waiting indefinitely (without a time out) for the semaphore to be available. Indefinite timeouts are often used in example code because their use simplifies the structure of the example, and therefore makes the example easier to understand. However, indefinite timeouts are normally bad practice in real applications, because they make it difficult to recover from an error. As an example, consider the scenario where a task is waiting for an interrupt to give a semaphore, but an error state in the hardware is preventing the interrupt from being generated:

- If the task is waiting without a time out, it will not know about the error state, and will wait forever.
- If the task is waiting with a time out, then `xSemaphoreTake()` will return `pdFAIL` when the time out expires, and the task can then detect and clear the error the next time it executes. This scenario is also demonstrated in Listing 96.

¹ Alternatively, a counting semaphore, or a direct to task notification, can be used to count events. Counting semaphores are described in the next section. Direct to task notifications are described in Chapter 9, Task Notifications. Direct to task notifications are the preferred method as they are the most efficient in both run time and RAM usage.

```
static void vUARTReceiveHandlerTask( void *pvParameters )
{
    /* xMaxExpectedBlockTime holds the maximum time expected between two interrupts. */
    const TickType_t xMaxExpectedBlockTime = pdMS_TO_TICKS( 500 );

    /* As per most tasks, this task is implemented within an infinite loop. */
    for( ;; )
    {
        /* The semaphore is 'given' by the UART's receive (Rx) interrupt. Wait a
        maximum of xMaxExpectedBlockTime ticks for the next interrupt. */
        if( xSemaphoreTake( xBinarySemaphore, xMaxExpectedBlockTime ) == pdPASS )
        {
            /* The semaphore was obtained. Process ALL pending Rx events before
            calling xSemaphoreTake() again. Each Rx event will have placed a
            character in the UART's receive FIFO, and UART_RxCount() is assumed to
            return the number of characters in the FIFO. */
            while( UART_RxCount() > 0 )
            {
                /* UART_ProcessNextRxEvent() is assumed to process one Rx character,
                reducing the number of characters in the FIFO by 1. */
                UART_ProcessNextRxEvent();
            }

            /* No more Rx events are pending (there are no more characters in the
            FIFO), so loop back and call xSemaphoreTake() to wait for the next
            interrupt. Any interrupts occurring between this point in the code and
            the call to xSemaphoreTake() will be latched in the semaphore, so will
            not be lost. */
        }
        else
        {
            /* An event was not received within the expected time. Check for, and if
            necessary clear, any error conditions in the UART that might be
            preventing the UART from generating any more interrupts. */
            UART_ClearErrors();
        }
    }
}
```

Listing 96. The recommended structure of a deferred interrupt processing task, using a UART receive handler as an example

6.5 Counting Semaphores

Just as binary semaphores can be thought of as queues that have a length of one, counting semaphores can be thought of as queues that have a length of more than one. Tasks are not interested in the data that is stored in the queue—just the number of items in the queue. `configUSE_COUNTING_SEMAPHORES` must be set to 1 in `FreeRTOSConfig.h` for counting semaphores to be available.

Each time a counting semaphore is ‘given’, another space in its queue is used. The number of items in the queue is the semaphore’s ‘count’ value.

Counting semaphores are typically used for two things:

1. Counting events¹

In this scenario, an event handler will ‘give’ a semaphore each time an event occurs—causing the semaphore’s count value to be incremented on each ‘give’. A task will ‘take’ a semaphore each time it processes an event—causing the semaphore’s count value to be decremented on each ‘take’. The count value is the difference between the number of events that have occurred and the number that have been processed. This mechanism is shown in Figure 55.

Counting semaphores that are used to count events are created with an initial count value of zero.

2. Resource management.

In this scenario, the count value indicates the number of resources available. To obtain control of a resource, a task must first obtain a semaphore—decrementing the semaphore’s count value. When the count value reaches zero, there are no free resources. When a task finishes with the resource, it ‘gives’ the semaphore back—incrementing the semaphore’s count value.

¹ It is more efficient to count events using a direct to task notification than it is using a counting semaphore. Direct to task notifications are not covered until Chapter 9.

Counting semaphores that are used to manage resources are created so that their initial count value equals the number of resources that are available. Chapter 7 covers using semaphores to manage resources.

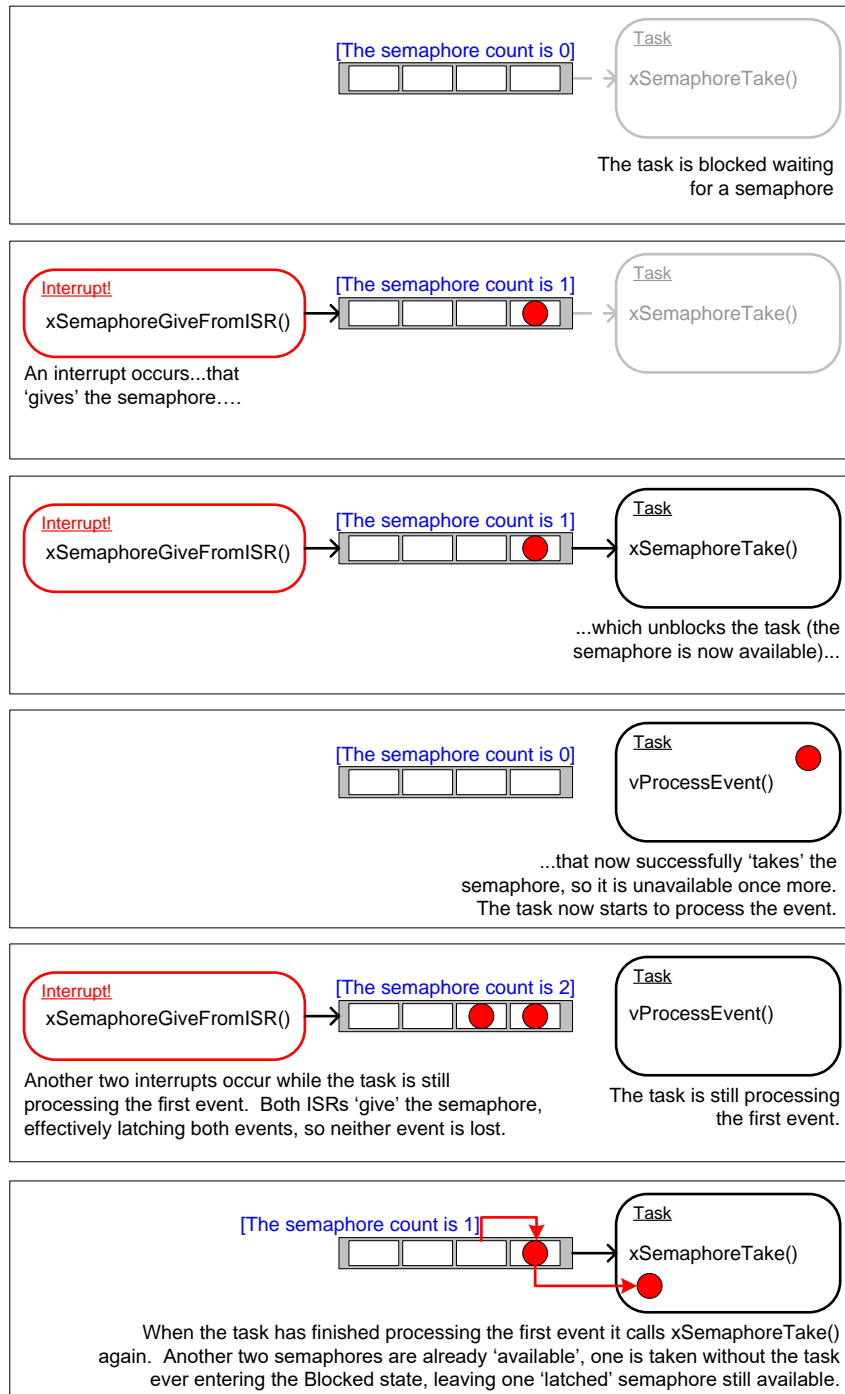

Figure 55. Using a counting semaphore to 'count' events

The xSemaphoreCreateCounting() API Function

FreeRTOS V9.0.0 also includes the xSemaphoreCreateCountingStatic() function, which allocates the memory required to create a counting semaphore statically at compile time: Handles to all the various types of FreeRTOS semaphore are stored in a variable of type SemaphoreHandle_t.

Before a semaphore can be used, it must be created. To create a counting semaphore, use the xSemaphoreCreateCounting() API function.

```
SemaphoreHandle_t xSemaphoreCreateCounting( UBaseType_t uxMaxCount,  
                                           UBaseType_t uxInitialCount );
```

Listing 97. The xSemaphoreCreateCounting() API function prototype

Table 36. xSemaphoreCreateCounting() parameters and return value

Parameter Name/ Returned Value	Description
uxMaxCount	<p>The maximum value to which the semaphore will count. To continue the queue analogy, the uxMaxCount value is effectively the length of the queue.</p> <p>When the semaphore is to be used to count or latch events, uxMaxCount is the maximum number of events that can be latched.</p> <p>When the semaphore is to be used to manage access to a collection of resources, uxMaxCount should be set to the total number of resources that are available.</p>
uxInitialCount	<p>The initial count value of the semaphore after it has been created.</p> <p>When the semaphore is to be used to count or latch events, uxInitialCount should be set to zero—as, presumably, when the semaphore is created, no events have yet occurred.</p> <p>When the semaphore is to be used to manage access to a collection of resources, uxInitialCount should be set to equal uxMaxCount—as, presumably, when the semaphore is created, all the resources are available.</p>

Table 36. xSemaphoreCreateCounting() parameters and return value

Parameter Name/ Returned Value	Description
Returned value	<p>If NULL is returned, the semaphore cannot be created because there is insufficient heap memory available for FreeRTOS to allocate the semaphore data structures. Chapter 2 provides more information on heap memory management.</p> <p>A non-NULL value being returned indicates that the semaphore has been created successfully. The returned value should be stored as the handle to the created semaphore.</p>

Example 17. Using a counting semaphore to synchronize a task with an interrupt

Example 17 improves on the Example 16 implementation by using a counting semaphore in place of the binary semaphore. `main()` is changed to include a call to `xSemaphoreCreateCounting()` in place of the call to `xSemaphoreCreateBinary()`. The new API call is shown in Listing 98.

```
/* Before a semaphore is used it must be explicitly created. In this example a
counting semaphore is created. The semaphore is created to have a maximum count
value of 10, and an initial count value of 0. */
xCountingSemaphore = xSemaphoreCreateCounting( 10, 0 );
```

Listing 98. The call to xSemaphoreCreateCounting() used to create the counting semaphore in Example 17

To simulate multiple events occurring at high frequency, the interrupt service routine is changed to 'give' the semaphore more than once per interrupt. Each event is latched in the semaphore's count value. The modified interrupt service routine is shown in Listing 99.

```

static uint32_t ulExampleInterruptHandler( void )
{
BaseType_t xHigherPriorityTaskWoken;

/* The xHigherPriorityTaskWoken parameter must be initialized to pdFALSE as it
will get set to pdTRUE inside the interrupt safe API function if a context switch
is required. */
xHigherPriorityTaskWoken = pdFALSE;

/* 'Give' the semaphore multiple times. The first will unblock the deferred
interrupt handling task, the following 'gives' are to demonstrate that the
semaphore latches the events to allow the task to which interrupts are deferred
to process them in turn, without events getting lost. This simulates multiple
interrupts being received by the processor, even though in this case the events
are simulated within a single interrupt occurrence. */
xSemaphoreGiveFromISR( xCountingSemaphore, &xHigherPriorityTaskWoken );
xSemaphoreGiveFromISR( xCountingSemaphore, &xHigherPriorityTaskWoken );
xSemaphoreGiveFromISR( xCountingSemaphore, &xHigherPriorityTaskWoken );

/* Pass the xHigherPriorityTaskWoken value into portYIELD_FROM_ISR(). If
xHigherPriorityTaskWoken was set to pdTRUE inside xSemaphoreGiveFromISR() then
calling portYIELD_FROM_ISR() will request a context switch. If
xHigherPriorityTaskWoken is still pdFALSE then calling portYIELD_FROM_ISR() will
have no effect. Unlike most FreeRTOS ports, the Windows port requires the ISR to
return a value - the return statement is inside the Windows version of
portYIELD_FROM_ISR(). */
portYIELD_FROM_ISR( xHigherPriorityTaskWoken );
}

```

Listing 99. The implementation of the interrupt service routine used by Example 17

All the other functions remain unmodified from those used in Example 16.

The output produced when Example 17 is executed is shown in Figure 56. As can be seen, the task to which interrupt handling is deferred processes all three [simulated] events each time an interrupt is generated. The events are latched into the count value of the semaphore, allowing the task to process them in turn.

```

C:\WINDOWS\system32\cmd.exe - rtosdemo
Handler task - Processing event.
Handler task - Processing event.
Handler task - Processing event.
Periodic task - Interrupt generated.

Periodic task - About to generate an interrupt.
Handler task - Processing event.
Handler task - Processing event.
Handler task - Processing event.
Periodic task - Interrupt generated.

Periodic task - About to generate an interrupt.
Handler task - Processing event.
Handler task - Processing event.
Handler task - Processing event.
Periodic task - Interrupt generated.

Periodic task - About to generate an interrupt.
Handler task - Processing event.
Handler task - Processing event.
Handler task - Processing event.

```

Figure 56. The output produced when Example 17 is executed

6.6 Deferring Work to the RTOS Daemon Task

The deferred interrupt handling examples presented so far have required the application writer to create a task for each interrupt that uses the deferred processing technique. It is also possible to use the `xTimerPendFunctionCallFromISR()`¹ API function to defer interrupt processing to the RTOS daemon task—removing the need to create a separate task for each interrupt. Deferring interrupt processing to the daemon task is called ‘centralized deferred interrupt processing’.

Chapter 5 described how software timer related FreeRTOS API functions send commands to the daemon task on the timer command queue. The `xTimerPendFunctionCall()` and `xTimerPendFunctionCallFromISR()` API functions use the same timer command queue to send an ‘execute function’ command to the daemon task. The function sent to the daemon task is then executed in the context of the daemon task.

Advantages of centralized deferred interrupt processing include:

- Lower resource usage

It removes the need to create a separate task for each deferred interrupt.

- Simplified user model

The deferred interrupt handling function is a standard C function.

Disadvantages of centralized deferred interrupt processing include:

- Less flexibility

It is not possible to set the priority of each deferred interrupt handling task separately. Each deferred interrupt handling function executes at the priority of the daemon task. As described in Chapter 5, the priority of the daemon task is set by the `configTIMER_TASK_PRIORITY` compile time configuration constant within `FreeRTOSConfig.h`.

- Less determinism

¹ It was noted in Chapter 5 that the daemon task was originally called the timer service task because it was originally only used to execute software timer callback functions. Hence, `xTimerPendFunctionCall()` is implemented in `timers.c`, and, in accordance with the convention of prefixing a function’s name with the name of the file in which the function is implemented, the function’s name is prefixed with ‘Timer’.

xTimerPendFunctionCallFromISR() sends a command to the back of the timer command queue. Commands that were already in the timer command queue will be processed by the daemon task before the 'execute function' command sent to the queue by xTimerPendFunctionCallFromISR().

Different interrupts have different timing constraints, so it is common to use both methods of deferring interrupt processing within the same application.

The xTimerPendFunctionCallFromISR() API Function

xTimerPendFunctionCallFromISR() is the interrupt safe version of xTimerPendFunctionCall(). Both API functions allow a function provided by the application writer to be executed by, and therefore in the context of, the RTOS daemon task. Both the function to be executed, and the value of the function's input parameters, are sent to the daemon task on the timer command queue. When the function actually executes is therefore dependent on the priority of the daemon task relative to other tasks in the application.

```
BaseType_t xTimerPendFunctionCallFromISR( PendedFunction_t xFunctionToPend,
                                         void *pvParameter1,
                                         uint32_t ulParameter2,
                                         BaseType_t *pxHigherPriorityTaskWoken );
```

Listing 100. The xTimerPendFunctionCallFromISR() API function prototype

```
void vPendableFunction( void *pvParameter1, uint32_t ulParameter2 );
```

Listing 101. The prototype to which a function passed in the xFunctionToPend parameter of xTimerPendFunctionCallFromISR() must conform

Table 37. xTimerPendFunctionCallFromISR() parameters and return value

Parameter Name/ Returned Value	Description
xFunctionToPend	A pointer to the function that will be executed in the daemon task (in effect, just the function name). The prototype of the function must be the same as that shown in Listing 101.

Table 37. xTimerPendFunctionCallFromISR() parameters and return value

Parameter Name/ Returned Value	Description
pvParameter1	The value that will be passed into the function that is executed by the daemon task as the function's pvParameter1 parameter. The parameter has a void * type to allow it to be used to pass any data type. For example, integer types can be directly cast to a void *, alternatively the void * can be used to point to a structure.
ulParameter2	The value that will be passed into the function that is executed by the daemon task as the function's ulParameter2 parameter.
pxHigherPriorityTaskWoken	<p>xTimerPendFunctionCallFromISR() writes to the timer command queue. If the RTOS daemon task was in the Blocked state to wait for data to become available on the timer command queue, then writing to the timer command queue will cause the daemon task to leave the Blocked state. If the priority of the daemon task is higher than the priority of the currently executing task (the task that was interrupted), then, internally, xTimerPendFunctionCallFromISR() will set *pxHigherPriorityTaskWoken to pdTRUE.</p> <p>If xTimerPendFunctionCallFromISR() sets this value to pdTRUE, then a context switch must be performed before the interrupt is exited. This will ensure that the interrupt returns directly to the daemon task, as the daemon task will be the highest priority Ready state task.</p>

Table 37. xTimerPendFunctionCallFromISR() parameters and return value

Parameter Name/ Returned Value	Description
Returned value	<p>There are two possible return values:</p> <ol style="list-style-type: none">1. pdPASS <p>pdPASS will be returned if the 'execute function' command was written to the timer command queue.</p> <ol style="list-style-type: none">2. pdFAIL <p>pdFAIL will be returned if the 'execute function' command could not be written to the timer command queue because the timer command queue was already full. Chapter 5 describes how to set the length of the timer command queue.</p>

Example 18. Centralized deferred interrupt processing

Example 18 provides similar functionality to Example 16, but without using a semaphore, and without creating a task specifically to perform the processing necessitated by the interrupt. Instead, the processing is performed by the RTOS daemon task.

The interrupt service routine used by Example 18 is shown in Listing 102. It calls xTimerPendFunctionCallFromISR() to pass a pointer to a function called vDeferredHandlingFunction() to the daemon task. The deferred interrupt processing is performed by the vDeferredHandlingFunction() function.

The interrupt service routine increments a variable called ulParameterValue each time it executes. ulParameterValue is used as the value of ulParameter2 in the call to xTimerPendFunctionCallFromISR(), so will also be used as the value of ulParameter2 in the call to vDeferredHandlingFunction() when vDeferredHandlingFunction() is executed by the daemon task. The function's other parameter, pvParameter1, is not used in this example.

```
static uint32_t ulExampleInterruptHandler( void )
{
static uint32_t ulParameterValue = 0;
 BaseType_t xHigherPriorityTaskWoken;

    /* The xHigherPriorityTaskWoken parameter must be initialized to pdFALSE as it will
    get set to pdTRUE inside the interrupt safe API function if a context switch is
    required. */
    xHigherPriorityTaskWoken = pdFALSE;

    /* Send a pointer to the interrupt's deferred handling function to the daemon task.
    The deferred handling function's pvParameter1 parameter is not used so just set to
    NULL. The deferred handling function's ulParameter2 parameter is used to pass a
    number that is incremented by one each time this interrupt handler executes. */
    xTimerPendFunctionCallFromISR( vDeferredHandlingFunction, /* Function to execute. */
                                   NULL, /* Not used. */
                                   ulParameterValue, /* Incrementing value. */
                                   &xHigherPriorityTaskWoken );

    ulParameterValue++;

    /* Pass the xHigherPriorityTaskWoken value into portYIELD_FROM_ISR(). If
    xHigherPriorityTaskWoken was set to pdTRUE inside xTimerPendFunctionCallFromISR() then
    calling portYIELD_FROM_ISR() will request a context switch. If
    xHigherPriorityTaskWoken is still pdFALSE then calling portYIELD_FROM_ISR() will have
    no effect. Unlike most FreeRTOS ports, the Windows port requires the ISR to return a
    value - the return statement is inside the Windows version of portYIELD_FROM_ISR(). */
    portYIELD_FROM_ISR( xHigherPriorityTaskWoken );
}
```

Listing 102. The software interrupt handler used in Example 18

The implementation of `vDeferredHandlingFunction()` is shown in Listing 103. It prints out a fixed string, and the value of its `ulParameter2` parameter.

`vDeferredHandlingFunction()` must have the prototype shown in Listing 101, even though, in this example, only one of its parameters is actually used.

```
static void vDeferredHandlingFunction( void *pvParameter1, uint32_t ulParameter2 )
{
    /* Process the event - in this case just print out a message and the value of
    ulParameter2. pvParameter1 is not used in this example. */
    vPrintStringAndNumber( "Handler function - Processing event ", ulParameter2 );
}
```

Listing 103. The function that performs the processing necessitated by the interrupt in Example 18.

The `main()` function used by Example 18 is shown in Listing 104. It is simpler than the `main()` function used by Example 16 because it does not create either a semaphore or a task to perform the deferred interrupt processing.

vPeriodicTask() is the task that periodically generates software interrupts. It is created with a priority below the priority of the daemon task to ensure it is pre-empted by the daemon task as soon as the daemon task leaves the Blocked state.

```
int main( void )
{
/* The task that generates the software interrupt is created at a priority below the
priority of the daemon task. The priority of the daemon task is set by the
configTIMER_TASK_PRIORITY compile time configuration constant in FreeRTOSConfig.h. */
const UBaseType_t ulPeriodicTaskPriority = configTIMER_TASK_PRIORITY - 1;

/* Create the task that will periodically generate a software interrupt. */
xTaskCreate( vPeriodicTask, "Periodic", 1000, NULL, ulPeriodicTaskPriority, NULL );

/* Install the handler for the software interrupt. The syntax necessary to do
this is dependent on the FreeRTOS port being used. The syntax shown here can
only be used with the FreeRTOS windows port, where such interrupts are only
simulated. */
vPortSetInterruptHandler( mainINTERRUPT_NUMBER, ulExampleInterruptHandler );

/* Start the scheduler so the created task starts executing. */
vTaskStartScheduler();

/* As normal, the following line should never be reached. */
for( ;; );
}
```

Listing 104. The implementation of main() for Example 18

Example 18 produces the output shown in Figure 57. The priority of the daemon task is higher than the priority of the task that generates the software interrupt, so vDeferredHandlingFunction() is executed by the daemon task as soon as the interrupt is generated. That results in the message output by vDeferredHandlingFunction() appearing in between the two messages output by the periodic task, just as it did when a semaphore was used to unblock a dedicated deferred interrupt processing task. Further explanation is provided in Figure 58.

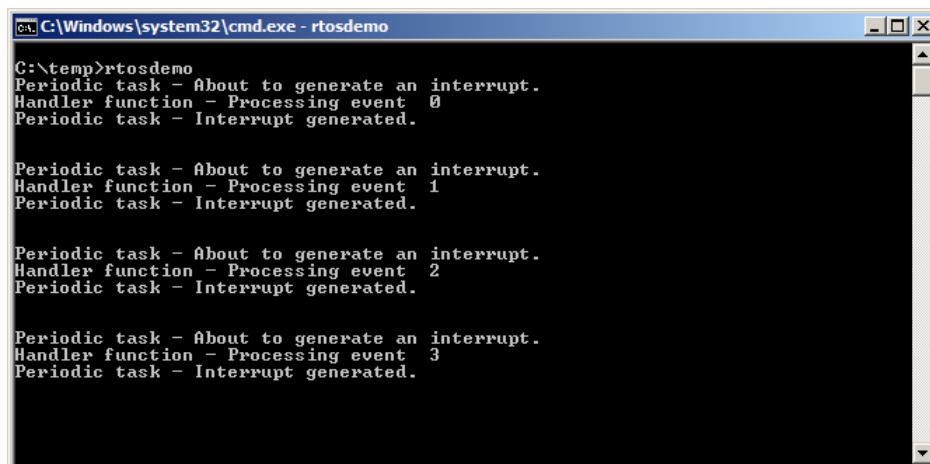

```
C:\Windows\system32\cmd.exe - rtosdemo
C:\temp>rtosdemo
Periodic task - About to generate an interrupt.
Handler function - Processing event 0
Periodic task - Interrupt generated.

Periodic task - About to generate an interrupt.
Handler function - Processing event 1
Periodic task - Interrupt generated.

Periodic task - About to generate an interrupt.
Handler function - Processing event 2
Periodic task - Interrupt generated.

Periodic task - About to generate an interrupt.
Handler function - Processing event 3
Periodic task - Interrupt generated.
```

Figure 57. The output produced when Example 18 is executed

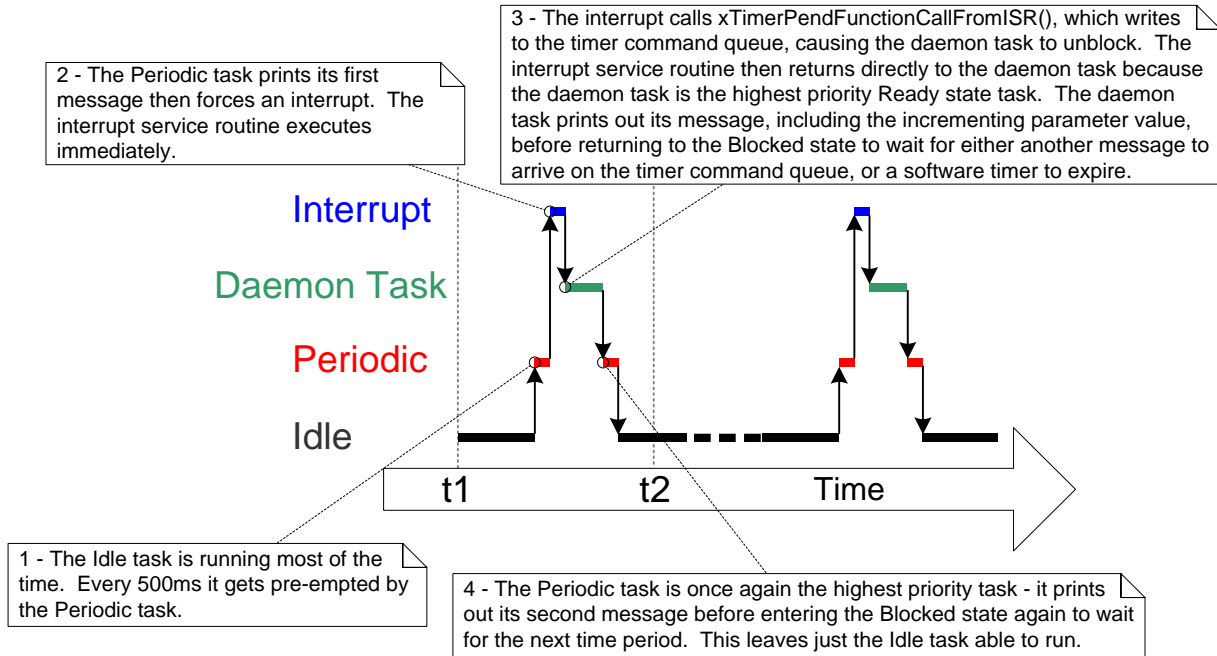

Figure 58 The sequence of execution when Example 18 is executed

6.7 Using Queues within an Interrupt Service Routine

Binary and counting semaphores are used to communicate events. Queues are used to communicate events, and to transfer data.

`xQueueSendToFrontFromISR()` is the version of `xQueueSendToFront()` that is safe to use in an interrupt service routine, `xQueueSendToBackFromISR()` is the version of `xQueueSendToBack()` that is safe to use in an interrupt service routine, and `xQueueReceiveFromISR()` is the version of `xQueueReceive()` that is safe to use in an interrupt service routine.

The `xQueueSendToFrontFromISR()` and `xQueueSendToBackFromISR()` API Functions

```
 BaseType_t xQueueSendToFrontFromISR( QueueHandle_t xQueue,
                                     void *pvItemToQueue
                                     BaseType_t *pxHigherPriorityTaskWoken
                                     );
```

Listing 105. The `xQueueSendToFrontFromISR()` API function prototype

```
 BaseType_t xQueueSendToBackFromISR( QueueHandle_t xQueue,
                                     void *pvItemToQueue
                                     BaseType_t *pxHigherPriorityTaskWoken
                                     );
```

Listing 106. The `xQueueSendToBackFromISR()` API function prototype

`xQueueSendFromISR()` and `xQueueSendToBackFromISR()` are functionally equivalent.

Table 38. `xQueueSendToFrontFromISR()` and `xQueueSendToBackFromISR()` parameters and return values

Parameter Name/ Returned Value	Description
<code>xQueue</code>	The handle of the queue to which the data is being sent (written). The queue handle will have been returned from the call to <code>xQueueCreate()</code> used to create the queue.

Table 38. xQueueSendToFrontFromISR() and xQueueSendToBackFromISR() parameters and return values

Parameter Name/ Returned Value	Description
pvItemToQueue	<p>A pointer to the data that will be copied into the queue.</p> <p>The size of each item the queue can hold is set when the queue is created, so this many bytes will be copied from pvItemToQueue into the queue storage area.</p>
pxHigherPriorityTaskWoken	<p>It is possible that a single queue will have one or more tasks blocked on it, waiting for data to become available. Calling xQueueSendToFrontFromISR() or xQueueSendToBackFromISR() can make data available, and so cause such a task to leave the Blocked state. If calling the API function causes a task to leave the Blocked state, and the unblocked task has a priority higher than the currently executing task (the task that was interrupted), then, internally, the API function will set *pxHigherPriorityTaskWoken to pdTRUE.</p> <p>If xQueueSendToFrontFromISR() or xQueueSendToBackFromISR() sets this value to pdTRUE, then a context switch should be performed before the interrupt is exited. This will ensure that the interrupt returns directly to the highest priority Ready state task.</p>
Returned value	<p>There are two possible return values:</p> <ol style="list-style-type: none">1. pdPASS <p>pdPASS is returned only if data has been sent successfully to the queue.</p> <ol style="list-style-type: none">2. errQUEUE_FULL <p>errQUEUE_FULL is returned if data cannot be sent to the queue because the queue is already full.</p>

Considerations When Using a Queue From an ISR

Queues provide an easy and convenient way of passing data from an interrupt to a task, but it is not efficient to use a queue if data is arriving at a high frequency.

Many of the demo applications in the FreeRTOS download include a simple UART driver that uses a queue to pass characters out of the UART's receive ISR. In those demos a queue is used for two reasons: to demonstrate queues being used from an ISR, and to deliberately load the system in order to test the FreeRTOS port. The ISRs that use a queue in this manner are definitely not intended to represent an efficient design, and unless the data is arriving slowly, it is recommended that production code does not copy the technique. More efficient techniques, that are suitable for production code, include:

- Using Direct Memory Access (DMA) hardware to receive and buffer characters. This method has practically no software overhead. A direct to task notification¹ can then be used to unblock the task that will process the buffer only after a break in transmission has been detected.
- Copying each received character into a thread safe RAM buffer². Again, a direct to task notification can be used to unblock the task that will process the buffer after a complete message has been received, or after a break in transmission has been detected.
- Processing the received characters directly within the ISR, then using a queue to send just the result of processing the data (rather than the raw data) to a task. This was previously demonstrated by Figure 34.

Example 19. Sending and receiving on a queue from within an interrupt

This example demonstrates `xQueueSendToBackFromISR()` and `xQueueReceiveFromISR()` being used within the same interrupt. As before, for convenience the interrupt is generated by software.

¹ Direct to task notifications provide the most efficient method of unblocking a task from an ISR. Direct to task notifications are covered in Chapter 9, Task Notifications.

² The 'Stream Buffer', provided as part of FreeRTOS+TCP (<http://www.FreeRTOS.org/tcp>), can be used for this purpose.

A periodic task is created that sends five numbers to a queue every 200 milliseconds. It generates a software interrupt only after all five values have been sent. The task implementation is shown in Listing 107.

```
static void vIntegerGenerator( void *pvParameters )
{
    TickType_t xLastExecutionTime;
    uint32_t ulValueToSend = 0;
    int i;

    /* Initialize the variable used by the call to vTaskDelayUntil(). */
    xLastExecutionTime = xTaskGetTickCount();

    for( ;; )
    {
        /* This is a periodic task. Block until it is time to run again. The task
        will execute every 200ms. */
        vTaskDelayUntil( &xLastExecutionTime, pdMS_TO_TICKS( 200 ) );

        /* Send five numbers to the queue, each value one higher than the previous
        value. The numbers are read from the queue by the interrupt service routine.
        The interrupt service routine always empties the queue, so this task is
        guaranteed to be able to write all five values without needing to specify a
        block time. */
        for( i = 0; i < 5; i++ )
        {
            xQueueSendToBack( xIntegerQueue, &ulValueToSend, 0 );
            ulValueToSend++;
        }

        /* Generate the interrupt so the interrupt service routine can read the
        values from the queue. The syntax used to generate a software interrupt is
        dependent on the FreeRTOS port being used. The syntax used below can only be
        used with the FreeRTOS Windows port, in which such interrupts are only
        simulated.*/
        vPrintString( "Generator task - About to generate an interrupt.\r\n" );
        vPortGenerateSimulatedInterrupt( mainINTERRUPT_NUMBER );
        vPrintString( "Generator task - Interrupt generated.\r\n\r\n\r\n" );
    }
}
```

Listing 107. The implementation of the task that writes to the queue in Example 19

The interrupt service routine calls `xQueueReceiveFromISR()` repeatedly until all the values written to the queue by the periodic task have been read out, and the queue is left empty. The last two bits of each received value are used as an index into an array of strings. A pointer to the string at the corresponding index position is then sent to a different queue using a call to `xQueueSendFromISR()`. The implementation of the interrupt service routine is shown in Listing 108.

```

static uint32_t ulExampleInterruptHandler( void )
{
BaseType_t xHigherPriorityTaskWoken;
uint32_t ulReceivedNumber;

/* The strings are declared static const to ensure they are not allocated on the
interrupt service routine's stack, and so exist even when the interrupt service
routine is not executing. */
static const char *pcStrings[] =
{
    "String 0\r\n",
    "String 1\r\n",
    "String 2\r\n",
    "String 3\r\n"
};

/* As always, xHigherPriorityTaskWoken is initialized to pdFALSE to be able to
detect it getting set to pdTRUE inside an interrupt safe API function. Note that
as an interrupt safe API function can only set xHigherPriorityTaskWoken to
pdTRUE, it is safe to use the same xHigherPriorityTaskWoken variable in both
the call to xQueueReceiveFromISR() and the call to xQueueSendToBackFromISR(). */
xHigherPriorityTaskWoken = pdFALSE;

/* Read from the queue until the queue is empty. */
while( xQueueReceiveFromISR( xIntegerQueue,
                             &ulReceivedNumber,
                             &xHigherPriorityTaskWoken ) != errQUEUE_EMPTY )
{
    /* Truncate the received value to the last two bits (values 0 to 3
    inclusive), then use the truncated value as an index into the pcStrings[]
    array to select a string (char *) to send on the other queue. */
    ulReceivedNumber &= 0x03;
    xQueueSendToBackFromISR( xStringQueue,
                             &pcStrings[ ulReceivedNumber ],
                             &xHigherPriorityTaskWoken );
}

/* If receiving from xIntegerQueue caused a task to leave the Blocked state, and
if the priority of the task that left the Blocked state is higher than the
priority of the task in the Running state, then xHigherPriorityTaskWoken will
have been set to pdTRUE inside xQueueReceiveFromISR().

If sending to xStringQueue caused a task to leave the Blocked state, and if the
priority of the task that left the Blocked state is higher than the priority of
the task in the Running state, then xHigherPriorityTaskWoken will have been set
to pdTRUE inside xQueueSendToBackFromISR().

xHigherPriorityTaskWoken is used as the parameter to portYIELD_FROM_ISR(). If
xHigherPriorityTaskWoken equals pdTRUE then calling portYIELD_FROM_ISR() will
request a context switch. If xHigherPriorityTaskWoken is still pdFALSE then
calling portYIELD_FROM_ISR() will have no effect.

The implementation of portYIELD_FROM_ISR() used by the Windows port includes a
return statement, which is why this function does not explicitly return a
value. */
portYIELD_FROM_ISR( xHigherPriorityTaskWoken );
}

```

Listing 108. The implementation of the interrupt service routine used by Example 19

The task that receives the character pointers from the interrupt service routine blocks on the queue until a message arrives, printing out each string as it is received. Its implementation is shown in Listing 109.

```
static void vStringPrinter( void *pvParameters )
{
    char *pcString;

    for( ;; )
    {
        /* Block on the queue to wait for data to arrive. */
        xQueueReceive( xStringQueue, &pcString, portMAX_DELAY );

        /* Print out the string received. */
        vPrintString( pcString );
    }
}
```

Listing 109. The task that prints out the strings received from the interrupt service routine in Example 19

As normal, main() creates the required queues and tasks before starting the scheduler. Its implementation is shown in Listing 110.

```

int main( void )
{
    /* Before a queue can be used it must first be created.  Create both queues used
    by this example.  One queue can hold variables of type uint32_t, the other queue
    can hold variables of type char*.  Both queues can hold a maximum of 10 items.  A
    real application should check the return values to ensure the queues have been
    successfully created. */
    xIntegerQueue = xQueueCreate( 10, sizeof( uint32_t ) );
    xStringQueue = xQueueCreate( 10, sizeof( char * ) );

    /* Create the task that uses a queue to pass integers to the interrupt service
    routine.  The task is created at priority 1. */
    xTaskCreate( vIntegerGenerator, "IntGen", 1000, NULL, 1, NULL );

    /* Create the task that prints out the strings sent to it from the interrupt
    service routine.  This task is created at the higher priority of 2. */
    xTaskCreate( vStringPrinter, "String", 1000, NULL, 2, NULL );

    /* Install the handler for the software interrupt.  The syntax necessary to do
    this is dependent on the FreeRTOS port being used.  The syntax shown here can
    only be used with the FreeRTOS Windows port, where such interrupts are only
    simulated. */
    vPortSetInterruptHandler( mainINTERRUPT_NUMBER, ulExampleInterruptHandler );

    /* Start the scheduler so the created tasks start executing. */
    vTaskStartScheduler();

    /* If all is well then main() will never reach here as the scheduler will now be
    running the tasks.  If main() does reach here then it is likely that there was
    insufficient heap memory available for the idle task to be created.  Chapter 2
    provides more information on heap memory management. */
    for( ;; );
}

```

Listing 110. The main() function for Example 19

The output produced when Example 19 is executed is shown in Figure 59. As can be seen, the interrupt receives all five integers, and produces five strings in response. More explanation is given in Figure 60.

```

C:\WINDOWS\system32\cmd.exe - rtosdemo
String 3
String 0
String 1
Generator task - Interrupt generated.

Generator task - About to generate an interrupt.
String 2
String 3
String 0
String 1
String 2
Generator task - Interrupt generated.

Generator task - About to generate an interrupt.
String 3
String 0
String 1
String 2
String 3
Generator task - Interrupt generated.

```

Figure 59. The output produced when Example 19 is executed

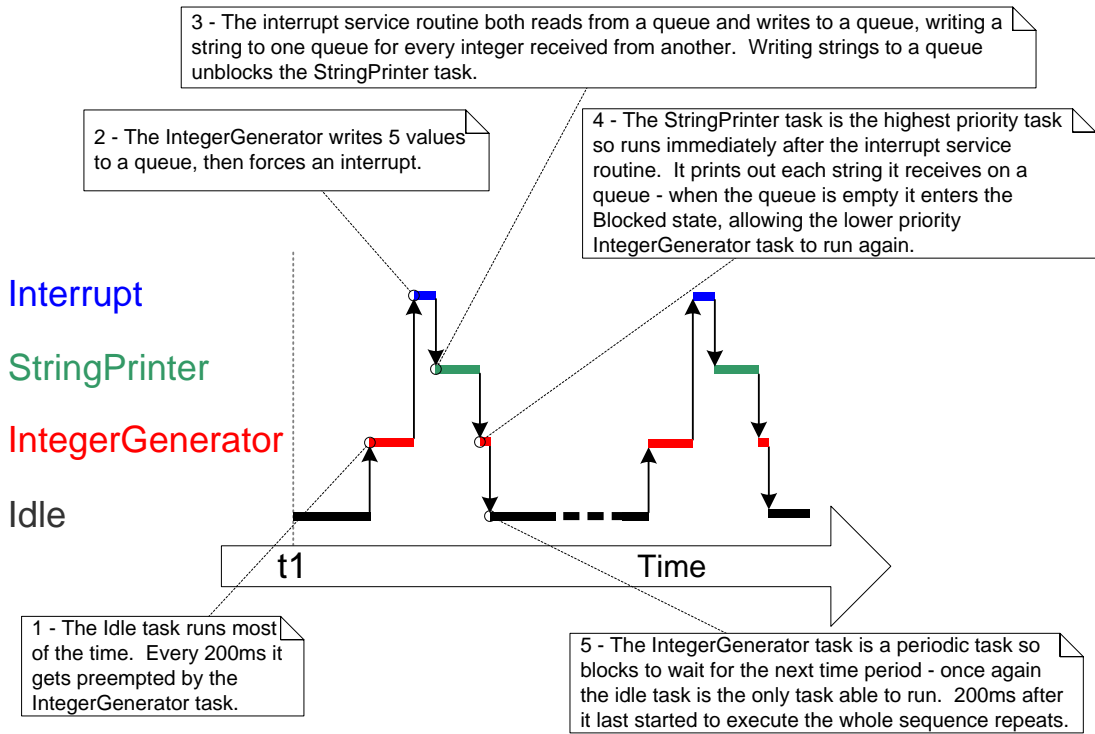

Figure 60. The sequence of execution produced by Example 19

6.8 Interrupt Nesting

It is common for confusion to arise between task priorities and interrupt priorities. This section discusses interrupt priorities, which are the priorities at which interrupt service routines (ISRs) execute relative to each other. The priority assigned to a task is in no way related to the priority assigned to an interrupt. Hardware decides when an ISR will execute, whereas software decides when a task will execute. An ISR executed in response to a hardware interrupt will interrupt a task, but a task cannot pre-empt an ISR.

Ports that support interrupt nesting require one or both of the constants detailed in Table 39 to be defined in `FreeRTOSConfig.h`. `configMAX_SYSCALL_INTERRUPT_PRIORITY` and `configMAX_API_CALL_INTERRUPT_PRIORITY` both define the same property. Older FreeRTOS ports use `configMAX_SYSCALL_INTERRUPT_PRIORITY`, and newer FreeRTOS port use `configMAX_API_CALL_INTERRUPT_PRIORITY`.

Table 39. Constants that control interrupt nesting

Constant	Description
<code>configMAX_SYSCALL_INTERRUPT_PRIORITY</code> or <code>configMAX_API_CALL_INTERRUPT_PRIORITY</code>	Sets the highest interrupt priority from which interrupt-safe FreeRTOS API functions can be called.
<code>configKERNEL_INTERRUPT_PRIORITY</code>	Sets the interrupt priority used by the tick interrupt, and must always be set to the lowest possible interrupt priority. If the FreeRTOS port in use does not also use the <code>configMAX_SYSCALL_INTERRUPT_PRIORITY</code> constant, then any interrupt that uses interrupt-safe FreeRTOS API functions must also execute at the priority defined by <code>configKERNEL_INTERRUPT_PRIORITY</code> .

Each interrupt source has a numeric priority, and a logical priority:

- Numeric priority

The numeric priority is simply the number assigned to the interrupt priority. For example, if an interrupt is assigned a priority of 7, then its numeric priority is 7. Likewise, if an interrupt is assigned a priority of 200, then its numeric priority is 200.

- Logical priority

An interrupt's logical priority describes that interrupt's precedence over other interrupts.

If two interrupts of differing priority occur at the same time, then the processor will execute the ISR for whichever of the two interrupts has the higher logical priority before it executes the ISR for whichever of the two interrupts has the lower logical priority.

An interrupt can interrupt (nest with) any interrupt that has a lower logical priority, but an interrupt cannot interrupt (nest with) any interrupt that has an equal or higher logical priority.

The relationship between an interrupt's numeric priority and logical priority is dependent on the processor architecture; on some processors, the higher the numeric priority assigned to an interrupt the *higher* that interrupt's logical priority will be, while on other processor architectures the higher the numeric priority assigned to an interrupt the *lower* that interrupt's logical priority will be.

A full interrupt nesting model is created by setting `configMAX_SYSCALL_INTERRUPT_PRIORITY` to a higher logical interrupt priority than `configKERNEL_INTERRUPT_PRIORITY`. This is demonstrated in Figure 61, which shows a scenario where:

- The processor has seven unique interrupt priorities.
- Interrupts assigned a numeric priority of 7 have a higher logical priority than interrupts assigned a numeric priority of 1.
- `configKERNEL_INTERRUPT_PRIORITY` is set to one.
- `configMAX_SYSCALL_INTERRUPT_PRIORITY` is set to three.

```
configMAX_SYSCALL_INTERRUPT_PRIORITY = 3
configKERNEL_INTERRUPT_PRIORITY = 1
```

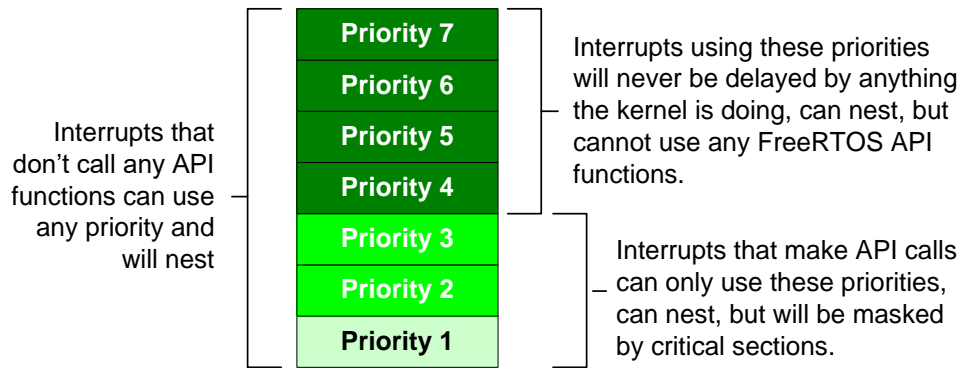

Figure 61. Constants affecting interrupt nesting behavior

Referring to Figure 61:

- Interrupts that use priorities 1 to 3, inclusive, are prevented from executing while the kernel or the application is inside a critical section. ISRs running at these priorities can use interrupt-safe FreeRTOS API functions. Critical sections are described in Chapter 7.
- Interrupts that use priority 4, or above, are not affected by critical sections, so nothing the scheduler does will prevent these interrupts from executing immediately—within the limitations of the hardware itself. ISRs executing at these priorities cannot use any FreeRTOS API functions.
- Typically, functionality that requires very strict timing accuracy (motor control, for example) would use a priority above `configMAX_SYSCALL_INTERRUPT_PRIORITY` to ensure the scheduler does not introduce jitter into the interrupt response time.

A Note to ARM Cortex-M¹ and ARM GIC Users

Interrupt configuration on Cortex-M processors is confusing, and prone to error. To assist your development, the FreeRTOS Cortex-M ports automatically check the interrupt configuration, but only if `configASSERT()` is defined. `configASSERT()` is described in section 11.2.

¹ This section only partially applies to Cortex-M0 and Cortex-M0+ cores.

The ARM Cortex cores, and ARM Generic Interrupt Controllers (GICs), use numerically *low* priority numbers to represent logically *high* priority interrupts. This can seem counter-intuitive, and is easy to forget. If you wish to assign an interrupt a logically low priority, then it must be assigned a numerically high value. If you wish to assign an interrupt a logically high priority, then it must be assigned a numerically low value.

The Cortex-M interrupt controller allows a maximum of eight bits to be used to specify each interrupt priority, making 255 the lowest possible priority. Zero is the highest priority. However, Cortex-M microcontrollers normally only implement a subset of the eight possible bits. The number of bits actually implemented is dependent on the microcontroller family.

When only a subset of the eight possible bits has been implemented, it is only the most significant bits of the byte that can be used—leaving the least significant bits unimplemented. Unimplemented bits can take any value, but it is normal to set them to 1. This is demonstrated by Figure 62, which shows how a priority of binary 101 is stored in a Cortex-M microcontroller that implements four priority bits.

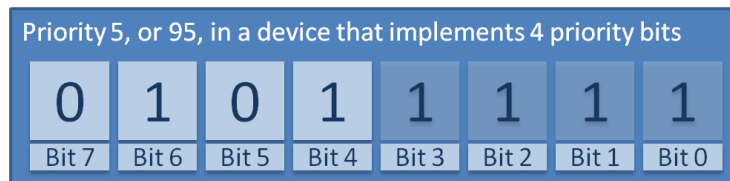

Figure 62 How a priority of binary 101 is stored by a Cortex-M microcontroller that implements four priority bits

In Figure 62 the binary value 101 has been shifted into the most significant four bits because the least significant four bits are not implemented. The unimplemented bits have been set to 1.

Some library functions expect priority values to be specified after they have been shifted up into the implemented (most significant) bits. When using such a function the priority shown in Figure 62 can be specified as decimal 95. Decimal 95 is binary 101 shifted up by four to make binary 101nnnn (where 'n' is an unimplemented bit), and with the unimplemented bits set to 1 to make binary 1011111.

Some library functions expect priority values to be specified before they have been shifted up into the implemented (most significant) bits. When using such a function the priority shown in Figure 62 must be specified as decimal 5. Decimal 5 is binary 101 without any shift.

`configMAX_SYSCALL_INTERRUPT_PRIORITY` and `configKERNEL_INTERRUPT_PRIORITY` must be specified in a way that allows them to be written directly to the Cortex-M registers, so after the priority values have been shifted up into the implemented bits.

`configKERNEL_INTERRUPT_PRIORITY` must always be set to the lowest possible interrupt priority. Unimplemented priority bits can be set to 1, so the constant can always be set to 255, no matter how many priority bits are actually implemented.

Cortex-M interrupts will default to a priority of zero—the highest possible priority. The implementation of the Cortex-M hardware does not permit `configMAX_SYSCALL_INTERRUPT_PRIORITY` to be set to 0, so the priority of an interrupt that uses the FreeRTOS API must never be left at its default value.

Chapter 7

Resource Management

7.1 Chapter Introduction and Scope

In a multitasking system there is potential for error if one task starts to access a resource, but does not complete its access before being transitioned out of the Running state. If the task leaves the resource in an inconsistent state, then access to the same resource by any other task or interrupt could result in data corruption, or other similar issue.

Following are some examples:

1. Accessing Peripherals

Consider the following scenario where two tasks attempt to write to an Liquid Crystal Display (LCD).

1. Task A executes and starts to write the string “Hello world” to the LCD.
2. Task A is pre-empted by Task B after outputting just the beginning of the string—“Hello w”.
3. Task B writes “Abort, Retry, Fail?” to the LCD before entering the Blocked state.
4. Task A continues from the point at which it was pre-empted, and completes outputting the remaining characters of its string—“orld”.

The LCD now displays the corrupted string “Hello wAbort, Retry, Fail?orld”.

2. Read, Modify, Write Operations

Listing 111 shows a line of C code, and an example of how the C code would typically be translated into assembly code. It can be seen that the value of PORTA is first read from memory into a register, modified within the register, and then written back to memory. This is called a read, modify, write operation.

```
/* The C code being compiled. */
PORTA |= 0x01;

/* The assembly code produced when the C code is compiled. */
LOAD  R1,[#PORTA] ; Read a value from PORTA into R1
MOVE  R2,#0x01    ; Move the absolute constant 1 into R2
OR    R1,R2       ; Bitwise OR R1 (PORTA) with R2 (constant 1)
STORE R1,[#PORTA] ; Store the new value back to PORTA
```

Listing 111. An example read, modify, write sequence

This is a 'non-atomic' operation because it takes more than one instruction to complete, and can be interrupted. Consider the following scenario where two tasks attempt to update a memory mapped register called PORTA.

1. Task A loads the value of PORTA into a register—the read portion of the operation.
2. Task A is pre-empted by Task B before it completes the modify and write portions of the same operation.
3. Task B updates the value of PORTA, then enters the Blocked state.
4. Task A continues from the point at which it was pre-empted. It modifies the copy of the PORTA value that it already holds in a register, before writing the updated value back to PORTA.

In this scenario, Task A updates and writes back an out of date value for PORTA. Task B modifies PORTA after Task A takes a copy of the PORTA value, and before Task A writes its modified value back to the PORTA register. When Task A writes to PORTA, it overwrites the modification that has already been performed by Task B, effectively corrupting the PORTA register value.

This example uses a peripheral register, but the same principle applies when performing read, modify, write operations on variables.

3. Non-atomic Access to Variables

Updating multiple members of a structure, or updating a variable that is larger than the natural word size of the architecture (for example, updating a 32-bit variable on a 16-bit machine), are examples of non-atomic operations. If they are interrupted, they can result in data loss or corruption.

4. Function Reentrancy

A function is 'reentrant' if it is safe to call the function from more than one task, or from both tasks and interrupts. Reentrant functions are said to be 'thread safe' because they can be accessed from more than one thread of execution without the risk of data or logical operations becoming corrupted.

Each task maintains its own stack and its own set of processor (hardware) register values. If a function does not access any data other than data stored on the stack or held in a

register, then the function is reentrant, and thread safe. Listing 112 is an example of a reentrant function. Listing 113 is an example of a function that is not reentrant.

```
/* A parameter is passed into the function. This will either be passed on the stack,
or in a processor register. Either way is safe as each task or interrupt that calls
the function maintains its own stack and its own set of register values, so each task
or interrupt that calls the function will have its own copy of lVar1. */
long lAddOneHundred( long lVar1 )
{
/* This function scope variable will also be allocated to the stack or a register,
depending on the compiler and optimization level. Each task or interrupt that calls
this function will have its own copy of lVar2. */
long lVar2;

    lVar2 = lVar1 + 100;
    return lVar2;
}
```

Listing 112. An example of a reentrant function

```
/* In this case lVar1 is a global variable, so every task that calls
lNonsenseFunction will access the same single copy of the variable. */
long lVar1;

long lNonsenseFunction( void )
{
/* lState is static, so is not allocated on the stack. Each task that calls this
function will access the same single copy of the variable. */
static long lState = 0;
long lReturn;

    switch( lState )
    {
        case 0 : lReturn = lVar1 + 10;
                 lState = 1;
                 break;

        case 1 : lReturn = lVar1 + 20;
                 lState = 0;
                 break;
    }
}
```

Listing 113. An example of a function that is not reentrant

Mutual Exclusion

To ensure data consistency is maintained at all times access to a resource that is shared between tasks, or between tasks and interrupts, must be managed using a 'mutual exclusion' technique. The goal is to ensure that, once a task starts to access a shared resource that is not re-entrant and not thread-safe, the same task has exclusive access to the resource until the resource has been returned to a consistent state.

FreeRTOS provides several features that can be used to implement mutual exclusion, but the best mutual exclusion method is to (whenever possible, as it is often not practical) design the application in such a way that resources are not shared, and each resource is accessed only from a single task.

Scope

This chapter aims to give readers a good understanding of:

- When and why resource management and control is necessary.
- What a critical section is.
- What mutual exclusion means.
- What it means to suspend the scheduler.
- How to use a mutex.
- How to create and use a gatekeeper task.
- What priority inversion is, and how priority inheritance can reduce (but not remove) its impact.

7.2 Critical Sections and Suspending the Scheduler

Basic Critical Sections

Basic critical sections are regions of code that are surrounded by calls to the macros `taskENTER_CRITICAL()` and `taskEXIT_CRITICAL()`, respectively. Critical sections are also known as critical regions.

`taskENTER_CRITICAL()` and `taskEXIT_CRITICAL()` do not take any parameters, or return a value¹. Their use is demonstrated in Listing 114.

```
/* Ensure access to the PORTA register cannot be interrupted by placing it within a
critical section. Enter the critical section. */
taskENTER_CRITICAL();

/* A switch to another task cannot occur between the call to taskENTER_CRITICAL() and
the call to taskEXIT_CRITICAL(). Interrupts may still execute on FreeRTOS ports that
allow interrupt nesting, but only interrupts whose logical priority is above the
value assigned to the configMAX_SYSCALL_INTERRUPT_PRIORITY constant - and those
interrupts are not permitted to call FreeRTOS API functions. */
PORTA |= 0x01;

/* Access to PORTA has finished, so it is safe to exit the critical section. */
taskEXIT_CRITICAL();
```

Listing 114. Using a critical section to guard access to a register

The example projects that accompany this book use a function called `vPrintString()` to write strings to standard out—which is the terminal window when the FreeRTOS Windows port is used. `vPrintString()` is called from many different tasks; so, in theory, its implementation could protect access to standard out using a critical section, as shown in Listing 115.

¹ A function like macro does not really ‘return a value’ in the same way that a real function does. This book applies the term ‘return a value’ to macros when it is simplest to think of the macro as if it were a function.

```
void vPrintString( const char *pcString )
{
    /* Write the string to stdout, using a critical section as a crude method of
    mutual exclusion. */
    taskENTER_CRITICAL();
    {
        printf( "%s", pcString );
        fflush( stdout );
    }
    taskEXIT_CRITICAL();
}
```

Listing 115. A possible implementation of vPrintString()

Critical sections implemented in this way are a very crude method of providing mutual exclusion. They work by disabling interrupts, either completely, or up to the interrupt priority set by `configMAX_SYSCALL_INTERRUPT_PRIORITY`—depending on the FreeRTOS port being used. Pre-emptive context switches can occur only from within an interrupt, so, as long as interrupts remain disabled, the task that called `taskENTER_CRITICAL()` is guaranteed to remain in the Running state until the critical section is exited.

Basic critical sections must be kept very short, otherwise they will adversely affect interrupt response times. Every call to `taskENTER_CRITICAL()` must be closely paired with a call to `taskEXIT_CRITICAL()`. For this reason, standard out (stdout, or the stream where a computer writes its output data) should not be protected using a critical section (as shown in Listing 115), because writing to the terminal can be a relatively long operation. The examples in this chapter explore alternative solutions.

It is safe for critical sections to become nested, because the kernel keeps a count of the nesting depth. The critical section will be exited only when the nesting depth returns to zero—which is when one call to `taskEXIT_CRITICAL()` has been executed for every preceding call to `taskENTER_CRITICAL()`.

Calling `taskENTER_CRITICAL()` and `taskEXIT_CRITICAL()` is the only legitimate way for a task to alter the interrupt enable state of the processor on which FreeRTOS is running. Altering the interrupt enable state by any other means will invalidate the macro's nesting count.

`taskENTER_CRITICAL()` and `taskEXIT_CRITICAL()` do not end in 'FromISR', so must not be called from an interrupt service routine. `taskENTER_CRITICAL_FROM_ISR()` is an interrupt safe version of `taskENTER_CRITICAL()`, and `taskEXIT_CRITICAL_FROM_ISR()` is an interrupt safe version of `taskEXIT_CRITICAL()`. The interrupt safe versions are only provided

for FreeRTOS ports that allow interrupts to nest—they would be obsolete in ports that do not allow interrupts to nest.

taskENTER_CRITICAL_FROM_ISR() returns a value that must be passed into the matching call to taskEXIT_CRITICAL_FROM_ISR(). This is demonstrated in Listing 116.

```
void vAnInterruptServiceRoutine( void )
{
    /* Declare a variable in which the return value from taskENTER_CRITICAL_FROM_ISR()
    will be saved. */
    UBaseType_t uxSavedInterruptStatus;

    /* This part of the ISR can be interrupted by any higher priority interrupt. */

    /* Use taskENTER_CRITICAL_FROM_ISR() to protect a region of this ISR. Save the
    value returned from taskENTER_CRITICAL_FROM_ISR() so it can be passed into the
    matching call to taskEXIT_CRITICAL_FROM_ISR(). */
    uxSavedInterruptStatus = taskENTER_CRITICAL_FROM_ISR();

    /* This part of the ISR is between the call to taskENTER_CRITICAL_FROM_ISR() and
    taskEXIT_CRITICAL_FROM_ISR(), so can only be interrupted by interrupts that have
    a priority above that set by the configMAX_SYSCALL_INTERRUPT_PRIORITY constant. */

    /* Exit the critical section again by calling taskEXIT_CRITICAL_FROM_ISR(),
    passing in the value returned by the matching call to
    taskENTER_CRITICAL_FROM_ISR(). */
    taskEXIT_CRITICAL_FROM_ISR( uxSavedInterruptStatus );

    /* This part of the ISR can be interrupted by any higher priority interrupt. */
}
```

Listing 116. Using a critical section in an interrupt service routine

It is wasteful to use more processing time executing the code that enters and then subsequently exits a critical section, than executing the code actually being protected by the critical section. Basic critical sections are very fast to enter, very fast to exit, and always deterministic, making their use ideal when the region of code being protected is very short.

Suspending (or Locking) the Scheduler

Critical sections can also be created by suspending the scheduler. Suspending the scheduler is sometimes also known as ‘locking’ the scheduler.

Basic critical sections protect a region of code from access by other tasks and by interrupts. A critical section implemented by suspending the scheduler only protects a region of code from access by other tasks, because interrupts remain enabled.

A critical section that is too long to be implemented by simply disabling interrupts can, instead, be implemented by suspending the scheduler. However, interrupt activity while the scheduler is suspended can make resuming (or ‘un-suspending’) the scheduler a relatively long operation, so consideration must be given to which is the best method to use in each case.

The vTaskSuspendAll() API Function

```
void vTaskSuspendAll( void );
```

Listing 117. The vTaskSuspendAll() API function prototype

The scheduler is suspended by calling vTaskSuspendAll(). Suspending the scheduler prevents a context switch from occurring, but leaves interrupts enabled. If an interrupt requests a context switch while the scheduler is suspended, then the request is held pending, and is performed only when the scheduler is resumed (un-suspended).

FreeRTOS API functions must not be called while the scheduler is suspended.

The xTaskResumeAll() API Function

```
BaseType_t xTaskResumeAll( void );
```

Listing 118. The xTaskResumeAll() API function prototype

The scheduler is resumed (un-suspended) by calling xTaskResumeAll().

Table 40. xTaskResumeAll() return value

Returned Value	Description
Returned value	Context switches that are requested while the scheduler is suspended are held pending and performed only as the scheduler is being resumed. If a pending context switch is performed before xTaskResumeAll() returns then pdTRUE is returned. Otherwise pdFALSE is returned.

It is safe for calls to `vTaskSuspendAll()` and `xTaskResumeAll()` to become nested, because the kernel keeps a count of the nesting depth. The scheduler will be resumed only when the nesting depth returns to zero—which is when one call to `xTaskResumeAll()` has been executed for every preceding call to `vTaskSuspendAll()`.

Listing 119 shows the actual implementation of `vPrintString()`, which suspends the scheduler to protect access to the terminal output.

```
void vPrintString( const char *pcString )
{
    /* Write the string to stdout, suspending the scheduler as a method of mutual
    exclusion. */
    vTaskSuspendScheduler();
    {
        printf( "%s", pcString );
        fflush( stdout );
    }
    xTaskResumeScheduler();
}
```

Listing 119. The implementation of `vPrintString()`

7.3 Mutexes (and Binary Semaphores)

A Mutex is a special type of binary semaphore that is used to control access to a resource that is shared between two or more tasks. The word MUTEX originates from 'MUTual EXclusion'. `configUSE_MUTEXES` must be set to 1 in `FreeRTOSConfig.h` for mutexes to be available.

When used in a mutual exclusion scenario, the mutex can be thought of as a token that is associated with the resource being shared. For a task to access the resource legitimately, it must first successfully 'take' the token (be the token holder). When the token holder has finished with the resource, it must 'give' the token back. Only when the token has been returned can another task successfully take the token, and then safely access the same shared resource. A task is not permitted to access the shared resource unless it holds the token. This mechanism is shown in Figure 63.

Even though mutexes and binary semaphores share many characteristics, the scenario shown in Figure 63 (where a mutex is used for mutual exclusion) is completely different to that shown in Figure 53 (where a binary semaphore is used for synchronization). The primary difference is what happens to the semaphore after it has been obtained:

- A semaphore that is used for mutual exclusion must always be returned.
- A semaphore that is used for synchronization is normally discarded and not returned.

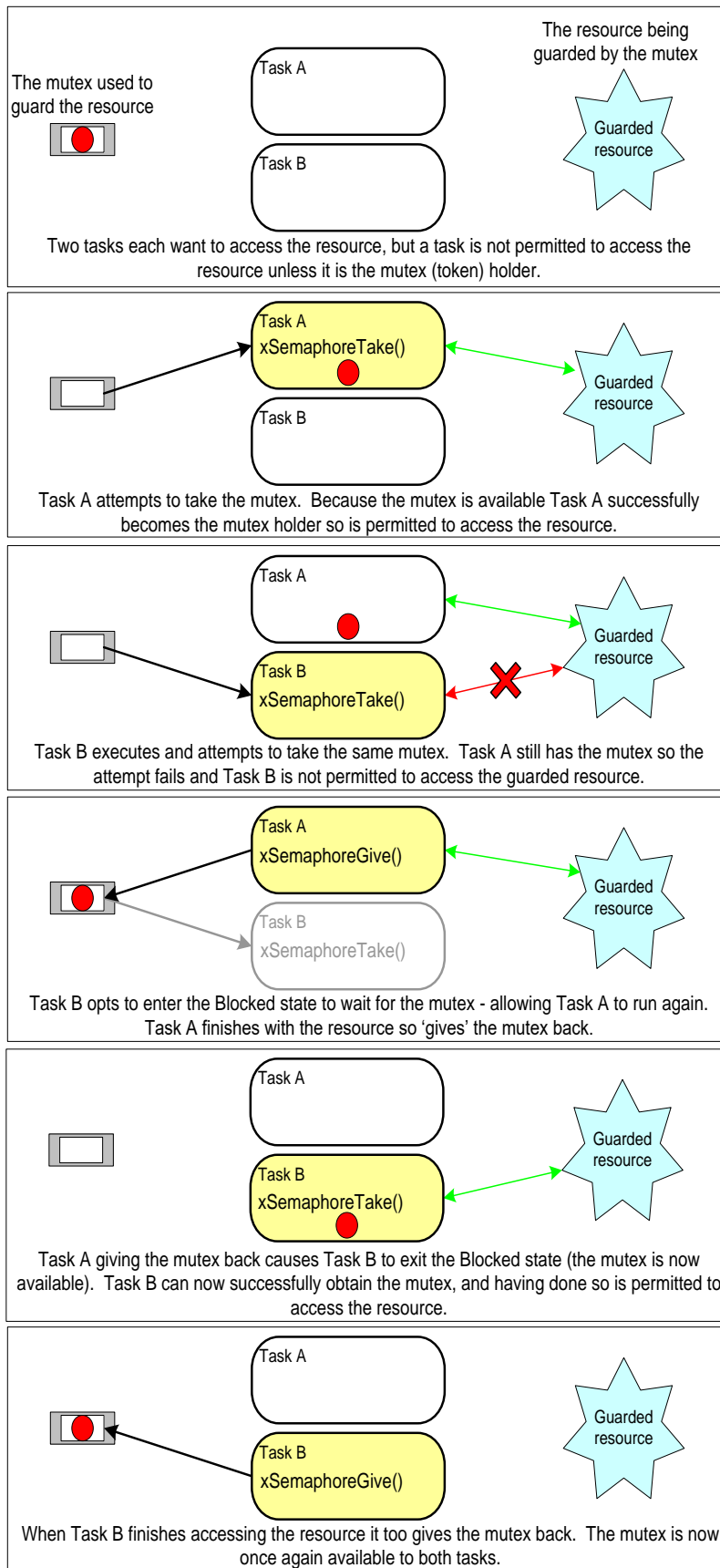

Figure 63. Mutual exclusion implemented using a mutex

The mechanism works purely through the discipline of the application writer. There is no reason why a task cannot access the resource at any time, but each task ‘agrees’ not to do so, unless it is able to become the mutex holder.

The xSemaphoreCreateMutex() API Function

FreeRTOS V9.0.0 also includes the xSemaphoreCreateMutexStatic() function, which allocates the memory required to create a mutex statically at compile time: A mutex is a type of semaphore. Handles to all the various types of FreeRTOS semaphore are stored in a variable of type SemaphoreHandle_t.

Before a mutex can be used, it must be created. To create a mutex type semaphore, use the xSemaphoreCreateMutex() API function.

```
SemaphoreHandle_t xSemaphoreCreateMutex( void );
```

Listing 120. The xSemaphoreCreateMutex() API function prototype

Table 41. xSemaphoreCreateMutex() return value

Parameter Name/ Returned Value	Description
Returned value	<p>If NULL is returned then the mutex could not be created because there is insufficient heap memory available for FreeRTOS to allocate the mutex data structures. Chapter 2 provides more information on heap memory management.</p> <p>A non-NULL return value indicates that the mutex has been created successfully. The returned value should be stored as the handle to the created mutex.</p>

Example 20. Rewriting vPrintString() to use a semaphore

This example creates a new version of vPrintString() called prvNewPrintString(), then calls the new function from multiple tasks. prvNewPrintString() is functionally identical to vPrintString(), but controls access to standard out using a mutex, rather than by locking the scheduler. The implementation of prvNewPrintString() is shown in Listing 121.

```

static void prvNewPrintString( const char *pcString )
{
    /* The mutex is created before the scheduler is started, so already exists by the
    time this task executes.

    Attempt to take the mutex, blocking indefinitely to wait for the mutex if it is
    not available straight away. The call to xSemaphoreTake() will only return when
    the mutex has been successfully obtained, so there is no need to check the
    function return value. If any other delay period was used then the code must
    check that xSemaphoreTake() returns pdTRUE before accessing the shared resource
    (which in this case is standard out). As noted earlier in this book, indefinite
    time outs are not recommended for production code. */
    xSemaphoreTake( xMutex, portMAX_DELAY );
    {
        /* The following line will only execute once the mutex has been successfully
        obtained. Standard out can be accessed freely now as only one task can have
        the mutex at any one time. */
        printf( "%s", pcString );
        fflush( stdout );

        /* The mutex MUST be given back! */
    }
    xSemaphoreGive( xMutex );
}

```

Listing 121. The implementation of prvNewPrintString()

prvNewPrintString() is called repeatedly by two instances of a task implemented by prvPrintTask(). A random delay time is used between each call. The task parameter is used to pass a unique string into each instance of the task. The implementation of prvPrintTask() is shown in Listing 122.

```
static void prvPrintTask( void *pvParameters )
{
char *pcStringToPrint;
const TickType_t xMaxBlockTimeTicks = 0x20;

    /* Two instances of this task are created. The string printed by the task is
    passed into the task using the task's parameter. The parameter is cast to the
    required type. */
    pcStringToPrint = ( char * ) pvParameters;

    for( ;; )
    {
        /* Print out the string using the newly defined function. */
        prvNewPrintString( pcStringToPrint );

        /* Wait a pseudo random time. Note that rand() is not necessarily reentrant,
        but in this case it does not really matter as the code does not care what
        value is returned. In a more secure application a version of rand() that is
        known to be reentrant should be used - or calls to rand() should be protected
        using a critical section. */
        vTaskDelay( ( rand() % xMaxBlockTimeTicks ) );
    }
}
```

Listing 122. The implementation of prvPrintTask() for Example 20

As normal, main() simply creates the mutex, creates the tasks, then starts the scheduler. The implementation is shown in Listing 123.

The two instances of prvPrintTask() are created at different priorities, so the lower priority task will sometimes be pre-empted by the higher priority task. As a mutex is used to ensure each task gets mutually exclusive access to the terminal, even when pre-emption occurs, the strings that are displayed will be correct and in no way corrupted. The frequency of pre-emption can be increased by reducing the maximum time the tasks spend in the Blocked state, which is set by the xMaxBlockTimeTicks constant.

Notes specific to using Example 20 with the FreeRTOS Windows port:

- Calling printf() generates a Windows system call. Windows system calls are outside the control of FreeRTOS, and can introduce instability.
- The way in which Windows system calls execute mean it is rare to see a corrupted string, even when the mutex is not used.

```

int main( void )
{
    /* Before a semaphore is used it must be explicitly created. In this example a
    mutex type semaphore is created. */
    xMutex = xSemaphoreCreateMutex();

    /* Check the semaphore was created successfully before creating the tasks. */
    if( xMutex != NULL )
    {
        /* Create two instances of the tasks that write to stdout. The string they
        write is passed in to the task as the task's parameter. The tasks are
        created at different priorities so some pre-emption will occur. */
        xTaskCreate( prvPrintTask, "Print1", 1000,
                    "Task 1 *****\r\n", 1, NULL );

        xTaskCreate( prvPrintTask, "Print2", 1000,
                    "Task 2 -----\r\n", 2, NULL );

        /* Start the scheduler so the created tasks start executing. */
        vTaskStartScheduler();
    }

    /* If all is well then main() will never reach here as the scheduler will now be
    running the tasks. If main() does reach here then it is likely that there was
    insufficient heap memory available for the idle task to be created. Chapter 2
    provides more information on heap memory management. */
    for( ;; );
}

```

Listing 123. The implementation of main() for Example 20

The output produced when Example 20 is executed is shown in Figure 64. A possible execution sequence is described in Figure 65.

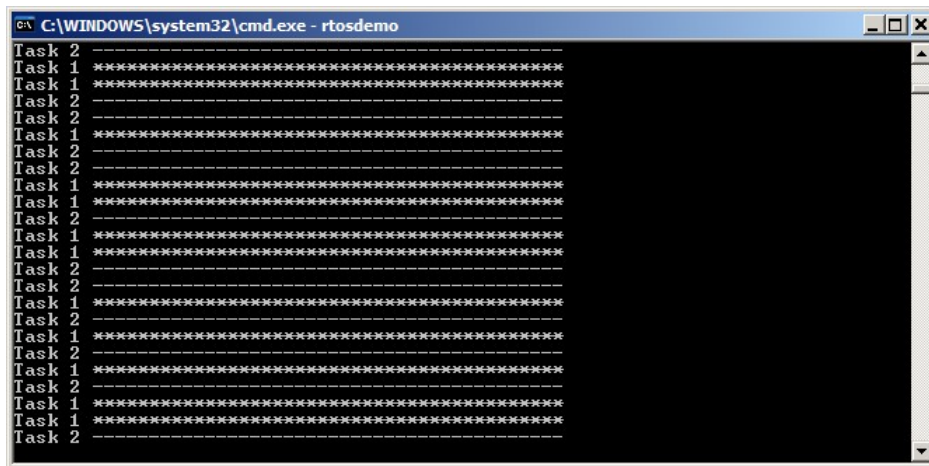

Figure 64. The output produced when Example 20 is executed

Figure 64 shows that, as expected, there is no corruption in the strings that are displayed on the terminal. The random ordering is a result of the random delay periods used by the tasks.

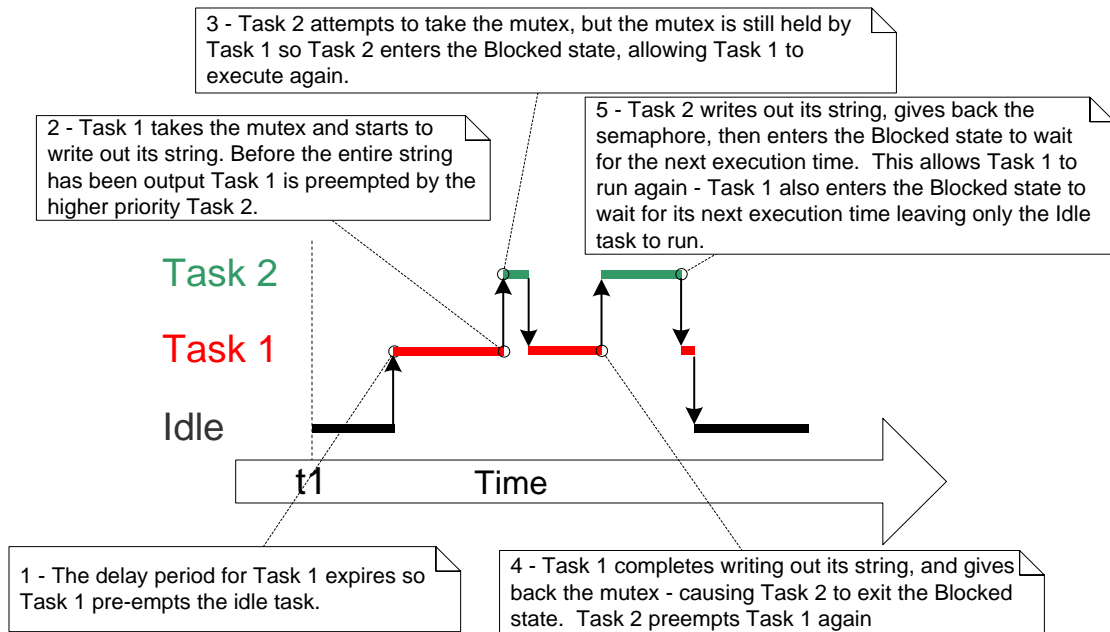

Figure 65. A possible sequence of execution for Example 20

Priority Inversion

Figure 65 demonstrates one of the potential pitfalls of using a mutex to provide mutual exclusion. The sequence of execution depicted shows the higher priority Task 2 having to wait for the lower priority Task 1 to give up control of the mutex. A higher priority task being delayed by a lower priority task in this manner is called 'priority inversion'. This undesirable behavior would be exaggerated further if a medium priority task started to execute while the high priority task was waiting for the semaphore—the result would be a high priority task waiting for a low priority task—without the low priority task even being able to execute. This worst case scenario is shown in Figure 66.

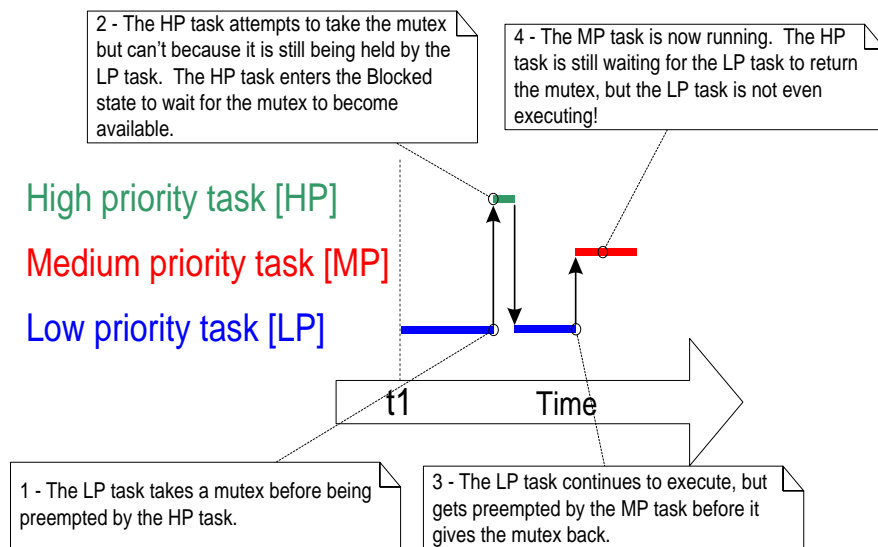

Figure 66. A worst case priority inversion scenario

Priority inversion can be a significant problem, but in small embedded systems it can often be avoided at system design time, by considering how resources are accessed.

Priority Inheritance

FreeRTOS mutexes and binary semaphores are very similar—the difference being that mutexes include a basic ‘priority inheritance’ mechanism, whereas binary semaphores do not. Priority inheritance is a scheme that minimizes the negative effects of priority inversion. It does not ‘fix’ priority inversion, but merely lessens its impact by ensuring that the inversion is always time bounded. However, priority inheritance complicates system timing analysis, and it is not good practice to rely on it for correct system operation.

Priority inheritance works by temporarily raising the priority of the mutex holder to the priority of the highest priority task that is attempting to obtain the same mutex. The low priority task that holds the mutex ‘inherits’ the priority of the task waiting for the mutex. This is demonstrated by Figure 67. The priority of the mutex holder is reset automatically to its original value when it gives the mutex back.

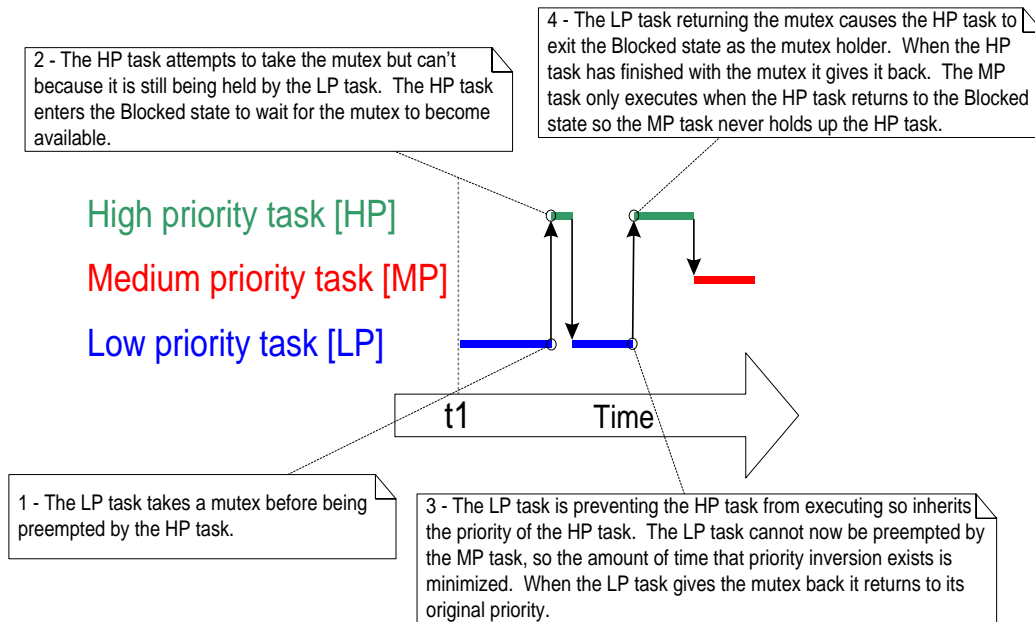

Figure 67. Priority inheritance minimizing the effect of priority inversion

As just seen, priority inheritance functionality effects the priority of tasks that are using the mutex. For that reason, mutexes must not be used from an interrupt service routines.

Deadlock (or Deadly Embrace)

'Deadlock' is another potential pitfall of using mutexes for mutual exclusion. Deadlock is sometimes also known by the more dramatic name 'deadly embrace'.

Deadlock occurs when two tasks cannot proceed because they are both waiting for a resource that is held by the other. Consider the following scenario where Task A and Task B both need to acquire mutex X *and* mutex Y in order to perform an action:

1. Task A executes and successfully takes mutex X.
2. Task A is pre-empted by Task B.
3. Task B successfully takes mutex Y before attempting to also take mutex X—but mutex X is held by Task A so is not available to Task B. Task B opts to enter the Blocked state to wait for mutex X to be released.
4. Task A continues executing. It attempts to take mutex Y—but mutex Y is held by Task B, so is not available to Task A. Task A opts to enter the Blocked state to wait for mutex Y to be released.

At the end of this scenario, Task A is waiting for a mutex held by Task B, and Task B is waiting for a mutex held by Task A. Deadlock has occurred because neither task can proceed.

As with priority inversion, the best method of avoiding deadlock is to consider its potential at design time, and design the system to ensure that deadlock cannot occur. In particular, and as previously stated in this book, it is normally bad practice for a task to wait indefinitely (without a time out) to obtain a mutex. Instead, use a time out that is a little longer than the maximum time it is expected to have to wait for the mutex—then failure to obtain the mutex within that time will be a symptom of a design error, which might be a deadlock.

In practice, deadlock is not a big problem in small embedded systems, because the system designers can have a good understanding of the entire application, and so can identify and remove the areas where it could occur.

Recursive Mutexes

It is also possible for a task to deadlock with itself. This will happen if a task attempts to take the same mutex more than once, without first returning the mutex. Consider the following scenario:

1. A task successfully obtains a mutex.
2. While holding the mutex, the task calls a library function.
3. The implementation of the library function attempts to take the same mutex, and enters the Blocked state to wait for the mutex to become available.

At the end of this scenario the task is in the Blocked state to wait for the mutex to be returned, but the task is already the mutex holder. A deadlock has occurred because the task is in the Blocked state to wait for itself.

This type of deadlock can be avoided by using a recursive mutex in place of a standard mutex. A recursive mutex can be 'taken' more than once by the same task, and will be returned only after one call to 'give' the recursive mutex has been executed for every preceding call to 'take' the recursive mutex.

Standard mutexes and recursive mutexes are created and used in a similar way:

- Standard mutexes are created using `xSemaphoreCreateMutex()`. Recursive mutexes are created using `xSemaphoreCreateRecursiveMutex()`. The two API functions have the same prototype.
- Standard mutexes are 'taken' using `xSemaphoreTake()`. Recursive mutexes are 'taken' using `xSemaphoreTakeRecursive()`. The two API functions have the same prototype.
- Standard mutexes are 'given' using `xSemaphoreGive()`. Recursive mutexes are 'given' using `xSemaphoreGiveRecursive()`. The two API functions have the same prototype.

Listing 124 demonstrates how to create and use a recursive mutex.

```

/* Recursive mutexes are variables of type SemaphoreHandle_t. */
SemaphoreHandle_t xRecursiveMutex;

/* The implementation of a task that creates and uses a recursive mutex. */
void vTaskFunction( void *pvParameters )
{
const TickType_t xMaxBlock20ms = pdMS_TO_TICKS( 20 );

/* Before a recursive mutex is used it must be explicitly created. */
xRecursiveMutex = xSemaphoreCreateRecursiveMutex();

/* Check the semaphore was created successfully. configASSERT() is described in
section 11.2. */
configASSERT( xRecursiveMutex );

/* As per most tasks, this task is implemented as an infinite loop. */
for( ;; )
{
/* ... */

/* Take the recursive mutex. */
if( xSemaphoreTakeRecursive( xRecursiveMutex, xMaxBlock20ms ) == pdPASS )
{
/* The recursive mutex was successfully obtained. The task can now access
the resource the mutex is protecting. At this point the recursive call
count (which is the number of nested calls to xSemaphoreTakeRecursive())
is 1, as the recursive mutex has only been taken once. */

/* While it already holds the recursive mutex, the task takes the mutex
again. In a real application, this is only likely to occur inside a sub-
function called by this task, as there is no practical reason to knowingly
take the same mutex more than once. The calling task is already the mutex
holder, so the second call to xSemaphoreTakeRecursive() does nothing more
than increment the recursive call count to 2. */
xSemaphoreTakeRecursive( xRecursiveMutex, xMaxBlock20ms );

/* ... */

/* The task returns the mutex after it has finished accessing the resource
the mutex is protecting. At this point the recursive call count is 2, so
the first call to xSemaphoreGiveRecursive() does not return the mutex.
Instead, it simply decrements the recursive call count back to 1. */
xSemaphoreGiveRecursive( xRecursiveMutex );

/* The next call to xSemaphoreGiveRecursive() decrements the recursive call
count to 0, so this time the recursive mutex is returned.*/
xSemaphoreGiveRecursive( xRecursiveMutex );

/* Now one call to xSemaphoreGiveRecursive() has been executed for every
proceeding call to xSemaphoreTakeRecursive(), so the task is no longer the
mutex holder.
}
}
}

```

Listing 124. Creating and using a recursive mutex

Mutexes and Task Scheduling

If two tasks of different priority use the same mutex, then the FreeRTOS scheduling policy makes the order in which the tasks will execute clear; the highest priority task that is able to run will be selected as the task that enters the Running state. For example, if a high priority task is in the Blocked state to wait for a mutex that is held by a low priority task, then the high priority task will pre-empt the low priority task as soon as the low priority task returns the mutex. The high priority task will then become the mutex holder. This scenario has already been seen in Figure 67.

It is however common to make an incorrect assumption as to the order in which the tasks will execute when the tasks have the same priority. If Task 1 and Task 2 have the same priority, and Task 1 is in the Blocked state to wait for a mutex that is held by Task 2, then Task 1 will not pre-empt Task 2 when Task 2 'gives' the mutex. Instead, Task 2 will remain in the Running state, and Task 1 will simply move from the Blocked state to the Ready state. This scenario is shown in Figure 68, in which the vertical lines mark the times at which a tick interrupt occurs.

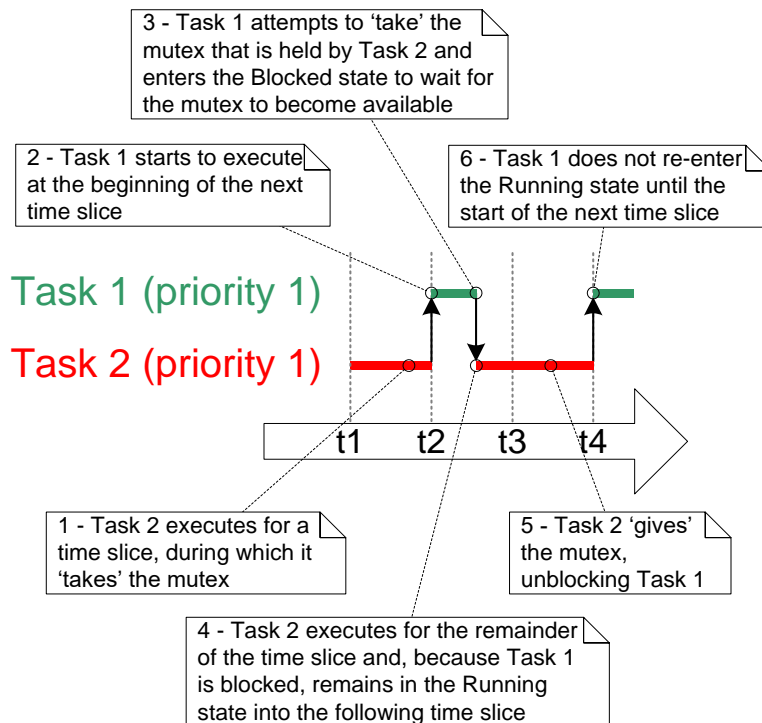

Figure 68 A possible sequence of execution when tasks that have the same priority use the same mutex

In the scenario shown in Figure 68, the FreeRTOS scheduler does *not* make Task 1 the Running state task as soon as the mutex is available because:

1. Task 1 and Task 2 have the same priority, so unless Task 2 enters the Blocked state, a switch to Task 1 should not occur until the next tick interrupt (assuming configUSE_TIME_SLICING is set to 1 in FreeRTOSConfig.h).
2. If a task uses a mutex in a tight loop, and a context switch occurred each time the task 'gave' the mutex, then the task would only ever remain in the Running state for a short time. If two or more tasks used the same mutex in a tight loop, then processing time would be wasted by rapidly switching between the tasks.

If a mutex is used in a tight loop by more than one task, and the tasks that use the mutex have the same priority, then care must be taken to ensure the tasks receive an approximately equal amount of processing time. The reason the tasks might not receive an equal amount of processing time is demonstrated by Figure 69, which shows a sequence of execution that could occur if two instances of the task shown by Listing 125 are created at the same priority.

```
/* The implementation of a task that uses a mutex in a tight loop. The task creates
a text string in a local buffer, then writes the string to a display. Access to the
display is protected by a mutex. */
void vATask( void *pvParameter )
{
extern SemaphoreHandle_t xMutex;
char cTextBuffer[ 128 ];

    for( ;; )
    {
        /* Generate the text string - this is a fast operation. */
        vGenerateTextInALocalBuffer( cTextBuffer );

        /* Obtain the mutex that is protecting access to the display. */
        xSemaphoreTake( xMutex, portMAX_DELAY );

        /* Write the generated text to the display - this is a slow operation. */
        vCopyTextToFrameBuffer( cTextBuffer );

        /* The text has been written to the display, so return the mutex. */
        xSemaphoreGive( xMutex );
    }
}
```

Listing 125. A task that uses a mutex in a tight loop

The comments in Listing 125 note that creating the string is a fast operation, and updating the display is a slow operation. Therefore, as the mutex is held while the display is being updated, the task will hold the mutex for the majority of its run time.

In Figure 69, the vertical lines mark the times at which a tick interrupt occurs.

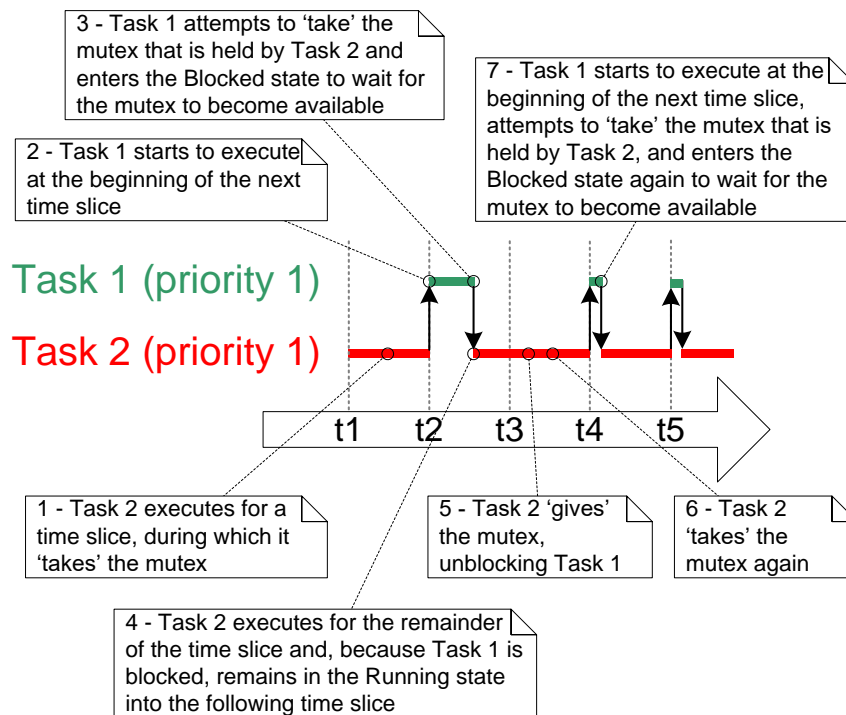

Figure 69 A sequence of execution that could occur if two instances of the task shown by Listing 125 are created at the same priority

Step 7 in Figure 69 shows Task 1 re-entering the Blocked state—that happens inside the `xSemaphoreTake()` API function.

Figure 69 demonstrates that Task 1 will be prevented from obtaining the mutex until the start of a time slice coincides with one of the short periods during which Task 2 is not the mutex holder.

The scenario shown in Figure 69 can be avoided by adding a call to `taskYIELD()` after the call to `xSemaphoreGive()`. This is demonstrated in Listing 126, where `taskYIELD()` is called if the tick count changed while the task held the mutex.

```

void vFunction( void *pvParameter )
{
extern SemaphoreHandle_t xMutex;
char cTextBuffer[ 128 ];
TickType_t xTimeAtWhichMutexWasTaken;

    for( ;; )
    {
        /* Generate the text string - this is a fast operation. */
        vGenerateTextInALocalBuffer( cTextBuffer );

        /* Obtain the mutex that is protecting access to the display. */
        xSemaphoreTake( xMutex, portMAX_DELAY );

        /* Record the time at which the mutex was taken. */
        xTimeAtWhichMutexWasTaken = xTaskGetTickCount();

        /* Write the generated text to the display - this is a slow operation. */
        vCopyTextToFrameBuffer( cTextBuffer );

        /* The text has been written to the display, so return the mutex. */
        xSemaphoreGive( xMutex );

        /* If taskYIELD() was called on each iteration then this task would only ever
        remain in the Running state for a short period of time, and processing time
        would be wasted by rapidly switching between tasks. Therefore, only call
        taskYIELD() if the tick count changed while the mutex was held. */
        if( xTaskGetTickCount() != xTimeAtWhichMutexWasTaken )
        {
            taskYIELD();
        }
    }
}

```

Listing 126. Ensuring tasks that use a mutex in a loop receive a more equal amount of processing time, while also ensuring processing time is not wasted by switching between tasks too rapidly

7.4 Gatekeeper Tasks

Gatekeeper tasks provide a clean method of implementing mutual exclusion without the risk of priority inversion or deadlock.

A gatekeeper task is a task that has sole ownership of a resource. Only the gatekeeper task is allowed to access the resource directly—any other task needing to access the resource can do so only indirectly by using the services of the gatekeeper.

Example 21. Re-writing vPrintString() to use a gatekeeper task

Example 21 provides another alternative implementation for vPrintString(). This time, a gatekeeper task is used to manage access to standard out. When a task wants to write a message to standard out, it does not call a print function directly but, instead, sends the message to the gatekeeper.

The gatekeeper task uses a FreeRTOS queue to serialize access to standard out. The internal implementation of the task does not have to consider mutual exclusion because it is the only task permitted to access standard out directly.

The gatekeeper task spends most of its time in the Blocked state, waiting for messages to arrive on the queue. When a message arrives, the gatekeeper simply writes the message to standard out, before returning to the Blocked state to wait for the next message. The implementation of the gatekeeper task is shown by Listing 128.

Interrupts can send to queues, so interrupt service routines can also safely use the services of the gatekeeper to write messages to the terminal. In this example, a tick hook function is used to write out a message every 200 ticks.

A tick hook (or tick callback) is a function that is called by the kernel during each tick interrupt. To use a tick hook function:

1. Set configUSE_TICK_HOOK to 1 in FreeRTOSConfig.h.
2. Provide the implementation of the hook function, using the exact function name and prototype shown in Listing 127.

```
void vApplicationTickHook( void );
```

Listing 127. The name and prototype for a tick hook function

Tick hook functions execute within the context of the tick interrupt, and so must be kept very short, must use only a moderate amount of stack space, and must not call any FreeRTOS API functions that do not end with 'FromISR()'.

The scheduler will always execute immediately after the tick hook function, so interrupt safe FreeRTOS API functions called from the tick hook do not need to use their pxHigherPriorityTaskWoken parameter, and the parameter can be set to NULL.

```
static void prvStdioGatekeeperTask( void *pvParameters )
{
char *pcMessageToPrint;

/* This is the only task that is allowed to write to standard out. Any other
task wanting to write a string to the output does not access standard out
directly, but instead sends the string to this task. As only this task accesses
standard out there are no mutual exclusion or serialization issues to consider
within the implementation of the task itself. */
for( ;; )
{
/* Wait for a message to arrive. An indefinite block time is specified so
there is no need to check the return value - the function will only return
when a message has been successfully received. */
xQueueReceive( xPrintQueue, &pcMessageToPrint, portMAX_DELAY );

/* Output the received string. */
printf( "%s", pcMessageToPrint );
fflush( stdout );

/* Loop back to wait for the next message. */
}
}
```

Listing 128. The gatekeeper task

The task that writes to the queue is shown in Listing 129. As before, two separate instances of the task are created, and the string the task writes to the queue is passed into the task using the task parameter.

```
static void prvPrintTask( void *pvParameters )
{
int iIndexToString;
const TickType_t xMaxBlockTimeTicks = 0x20;

    /* Two instances of this task are created. The task parameter is used to pass
    an index into an array of strings into the task. Cast this to the required
    type. */
    iIndexToString = ( int ) pvParameters;

    for( ;; )
    {
        /* Print out the string, not directly, but instead by passing a pointer to
        the string to the gatekeeper task via a queue. The queue is created before
        the scheduler is started so will already exist by the time this task executes
        for the first time. A block time is not specified because there should
        always be space in the queue. */
        xQueueSendToBack( xPrintQueue, &(amp; pcStringsToPrint[ iIndexToString ] ), 0 );

        /* Wait a pseudo random time. Note that rand() is not necessarily reentrant,
        but in this case it does not really matter as the code does not care what
        value is returned. In a more secure application a version of rand() that is
        known to be reentrant should be used - or calls to rand() should be protected
        using a critical section. */
        vTaskDelay( ( rand() % xMaxBlockTimeTicks ) );
    }
}
```

Listing 129. The print task implementation for Example 21

The tick hook function counts the number of times it is called, sending its message to the gatekeeper task each time the count reaches 200. For demonstration purposes only, the tick hook writes to the front of the queue, and the tasks write to the back of the queue. The tick hook implementation is shown in Listing 130.

```
void vApplicationTickHook( void )
{
static int iCount = 0;

    /* Print out a message every 200 ticks. The message is not written out directly,
    but sent to the gatekeeper task. */
    iCount++;
    if( iCount >= 200 )
    {
        /* As xQueueSendToFrontFromISR() is being called from the tick hook, it is
        not necessary to use the xHigherPriorityTaskWoken parameter (the third
        parameter), and the parameter is set to NULL. */
        xQueueSendToFrontFromISR( xPrintQueue,
                                  &( pcStringsToPrint[ 2 ] ),
                                  NULL );

        /* Reset the count ready to print out the string again in 200 ticks time. */
        iCount = 0;
    }
}
```

Listing 130. The tick hook implementation

As normal, main() creates the queues and tasks necessary to run the example, then starts the scheduler. The implementation of main() is shown in Listing 131.

```
/* Define the strings that the tasks and interrupt will print out via the
gatekeeper. */
static char *pcStringsToPrint[] =
{
    "Task 1 *****\r\n",
    "Task 2 ----- \r\n",
    "Message printed from the tick hook interrupt #####\r\n"
};

/*-----*/

/* Declare a variable of type QueueHandle_t. The queue is used to send messages
from the print tasks and the tick interrupt to the gatekeeper task. */
QueueHandle_t xPrintQueue;

/*-----*/

int main( void )
{
    /* Before a queue is used it must be explicitly created. The queue is created
to hold a maximum of 5 character pointers. */
    xPrintQueue = xQueueCreate( 5, sizeof( char * ) );

    /* Check the queue was created successfully. */
    if( xPrintQueue != NULL )
    {
        /* Create two instances of the tasks that send messages to the gatekeeper.
The index to the string the task uses is passed to the task via the task
parameter (the 4th parameter to xTaskCreate()). The tasks are created at
different priorities so the higher priority task will occasionally preempt
the lower priority task. */
        xTaskCreate( prvPrintTask, "Print1", 1000, ( void * ) 0, 1, NULL );
        xTaskCreate( prvPrintTask, "Print2", 1000, ( void * ) 1, 2, NULL );

        /* Create the gatekeeper task. This is the only task that is permitted
to directly access standard out. */
        xTaskCreate( prvStdioGatekeeperTask, "Gatekeeper", 1000, NULL, 0, NULL );

        /* Start the scheduler so the created tasks start executing. */
        vTaskStartScheduler();
    }

    /* If all is well then main() will never reach here as the scheduler will now be
running the tasks. If main() does reach here then it is likely that there was
insufficient heap memory available for the idle task to be created. Chapter 2
provides more information on heap memory management. */
    for( ;; );
}

```

Listing 131. The implementation of main() for Example 21

The output produced when Example 21 is executed is shown in Figure 70. As can be seen, the strings originating from the tasks, and the strings originating from the interrupt, all print out correctly with no corruption.

```
C:\WINDOWS\system32\cmd.exe - rtosdemo
Message printed from the tick hook interrupt #####
Message printed from the tick hook interrupt #####
Task 2 -----
Task 1 *****
Message printed from the tick hook interrupt #####
Task 1 *****
Message printed from the tick hook interrupt #####
Task 2 -----
Task 2 -----
Task 1 *****
Task 1 *****
Message printed from the tick hook interrupt #####
Message printed from the tick hook interrupt #####
Task 2 -----
Task 1 *****
Task 2 -----
Task 2 -----
Task 2 -----
Task 1 *****
Task 2 -----
Message printed from the tick hook interrupt #####
Task 1 *****
```

Figure 70. The output produced when Example 21 is executed

The gatekeeper task is assigned a lower priority than the print tasks—so messages sent to the gatekeeper remain in the queue until both print tasks are in the Blocked state. In some situations, it would be appropriate to assign the gatekeeper a higher priority, so messages get processed immediately—but doing so would be at the cost of the gatekeeper delaying lower priority tasks until it has completed accessing the protected resource.

Chapter 8

Event Groups

8.1 Chapter Introduction and Scope

It has already been noted that real-time embedded systems have to take actions in response to events. Previous chapters have described features of FreeRTOS that allow events to be communicated to tasks. Examples of such features include semaphores and queues, both of which have the following properties:

- They allow a task to wait in the Blocked state for a single event to occur.
- They unblock a single task when the event occurs—the task that is unblocked is the highest priority task that was waiting for the event.

Event groups are another feature of FreeRTOS that allow events to be communicated to tasks. Unlike queues and semaphores:

- Event groups allow a task to wait in the Blocked state for a combination of one or more events to occur.
- Event groups unblock all the tasks that were waiting for the same event, or combination of events, when the event occurs.

These unique properties of event groups make them useful for synchronizing multiple tasks, broadcasting events to more than one task, allowing a task to wait in the Blocked state for any one of a set of events to occur, and allowing a task to wait in the Blocked state for multiple actions to complete.

Event groups also provide the opportunity to reduce the RAM used by an application, as often it is possible to replace many binary semaphores with a single event group.

Event group functionality is optional. To include event group functionality, build the FreeRTOS source file `event_groups.c` as part of your project.

Scope

This chapter aims to give readers a good understanding of:

- Practical uses for event groups.

- The advantages and disadvantages of event groups relative to other FreeRTOS features.
- How to set bits in an event group.
- How to wait in the Blocked state for bits to become set in an event group.
- How to use an event group to synchronize a set of tasks.

8.2 Characteristics of an Event Group

Event Groups, Event Flags and Event Bits

An event 'flag' is a Boolean (1 or 0) value used to indicate if an event has occurred or not. An event 'group' is a set of event flags.

An event flag can only be 1 or 0, allowing the state of an event flag to be stored in a single bit, and the state of all the event flags in an event group to be stored in a single variable; the state of each event flag in an event group is represented by a single bit in a variable of type `EventBits_t`. For that reason, event flags are also known as event 'bits'. If a bit is set to 1 in the `EventBits_t` variable, then the event represented by that bit has occurred. If a bit is set to 0 in the `EventBits_t` variable, then the event represented by that bit has not occurred.

Figure 71 shows how individual event flags are mapped to individual bits in a variable of type `EventBits_t`.

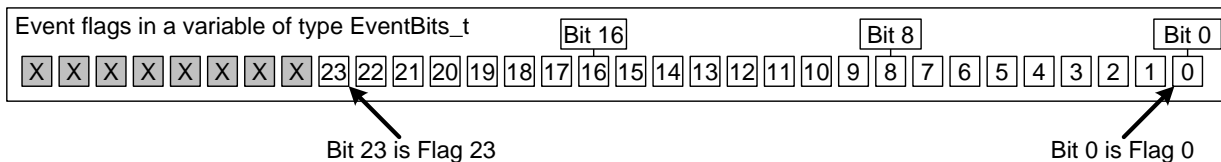

Figure 71 Event flag to bit number mapping in a variable of type `EventBits_t`

As an example, if the value of an event group is 0x92 (binary 1001 0010) then only event bits 1, 4 and 7 are set, so only the events represented by bits 1, 4 and 7 have occurred. Figure 72 shows a variable of type `EventBits_t` that has event bits 1, 4 and 7 set, and all the other event bits clear, giving the event group a value of 0x92.

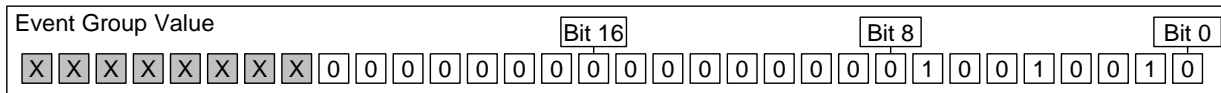

Figure 72 An event group in which only bits 1, 4 and 7 are set, and all the other event flags are clear, making the event group's value 0x92

It is up to the application writer to assign a meaning to individual bits within an event group. For example, the application writer might create an event group, then:

- Define bit 0 within the event group to mean “a message has been received from the network”.
- Define bit 1 within the event group to mean “a message is ready to be sent onto the network”.
- Define bit 2 within the event group to mean “abort the current network connection”.

More About the EventBits_t Data Type

The number of event bits in an event group is dependent on the configUSE_16_BIT_TICKS compile time configuration constant within FreeRTOSConfig.h¹:

- If configUSE_16_BIT_TICKS is 1, then each event group contains 8 usable event bits.
- If configUSE_16_BIT_TICKS is 0, then each event group contains 24 usable event bits.

Access by Multiple Tasks

Event groups are objects in their own right that can be accessed by any task or ISR that knows of their existence. Any number of tasks can set bits in the same event group, and any number of tasks can read bits from the same event group.

A Practical Example of Using an Event Group

The implementation of the FreeRTOS+TCP TCP/IP stack provides a practical example of how an event group can be used to simultaneously simplify a design, and minimize resource usage.

A TCP socket must respond to many different events. Examples of events include accept events, bind events, read events and close events. The events a socket can expect at any given time is dependent on the state of the socket. For example, if a socket has been created, but not yet bound to an address, then it can expect to receive a bind event, but would not expect to receive a read event (it cannot read data if it does not have an address).

¹ configUSE_16_BIT_TICKS configures the type used to hold the RTOS tick count, so would seem unrelated to the event groups feature. Its effect on the EventBits_t type is a consequence of FreeRTOS’s internal implementation, and desirable as configUSE_16_BIT_TICKS should only be set to 1 when FreeRTOS is executing on an architecture that can handle 16-bit types more efficiently than 32-bit types.

The state of a FreeRTOS+TCP socket is held in a structure called `FreeRTOS_Socket_t`. The structure contains an event group that has an event bit defined for each event the socket must process. FreeRTOS+TCP API calls that block to wait for an event, or group of events, simply block on the event group.

The event group also contains an 'abort' bit, allowing a TCP connection to be aborted, no matter which event the socket is waiting for at the time.

8.3 Event Management Using Event Groups

The xEventGroupCreate() API Function

FreeRTOS V9.0.0 also includes the xEventGroupCreateStatic() function, which allocates the memory required to create an event group statically at compile time: An event group must be explicitly created before it can be used.

Event groups are referenced using variables of type EventGroupHandle_t. The xEventGroupCreate() API function is used to create an event group, and returns an EventGroupHandle_t to reference the event group it creates.

```
EventGroupHandle_t xEventGroupCreate( void );
```

Listing 132. The xEventGroupCreate() API function prototype

Table 42, xEventGroupCreate() return value

Parameter Name	Description
Return Value	<p>If NULL is returned, then the event group cannot be created because there is insufficient heap memory available for FreeRTOS to allocate the event group data structures. Chapter 2 provides more information on heap memory management.</p> <p>A non-NULL value being returned indicates that the event group has been created successfully. The returned value should be stored as the handle to the created event group.</p>

The xEventGroupSetBits() API Function

The xEventGroupSetBits() API function sets one or more bits in an event group, and is typically used to notify a task that the events represented by the bit, or bits, being set has occurred.

Note: Never call xEventGroupSetBits() from an interrupt service routine. The interrupt-safe version xEventGroupSetBitsFromISR() should be used in its place.

```
EventBits_t xEventGroupSetBits( EventGroupHandle_t xEventGroup,  
                                const EventBits_t uxBitsToSet );
```

Listing 133. The xEventGroupSetBits() API function prototype

Table 43, xEventGroupSetBits() parameters and return value

Parameter Name	Description
xEventGroup	The handle of the event group in which bits are being set. The event group handle will have been returned from the call to xEventGroupCreate() used to create the event group.
uxBitsToSet	A bit mask that specifies the event bit, or event bits, to set to 1 in the event group. The value of the event group is updated by bitwise ORing the event group's existing value with the value passed in uxBitsToSet. As an example, setting uxBitsToSet to 0x04 (binary 0100) will result in event bit 3 in the event group becoming set (if it was not already set), while leaving all the other event bits in the event group unchanged.
Returned Value	The value of the event group at the time the call to xEventGroupSetBits() returned. Note that the value returned will not necessarily have the bits specified by uxBitsToSet set, because the bits may have been cleared again by a different task.

The xEventGroupSetBitsFromISR() API Function

xEventGroupSetBitsFromISR() is the interrupt safe version of xEventGroupSetBits().

Giving a semaphore is a deterministic operation because it is known in advance that giving a semaphore can result in at most one task leaving the Blocked state. When bits are set in an event group it is not known in advance how many tasks will leave the Blocked state, so setting bits in an event group is not a deterministic operation.

The FreeRTOS design and implementation standard does not permit non-deterministic operations to be performed inside an interrupt service routine, or when interrupts are disabled. For that reason, xEventGroupSetBitsFromISR() does not set event bits directly inside the interrupt service routine, but instead defers the action to the RTOS daemon task.

```
 BaseType_t xEventGroupSetBitsFromISR( EventGroupHandle_t xEventGroup,
                                       const EventBits_t uxBitsToSet,
                                       BaseType_t *pxHigherPriorityTaskWoken );
```

Listing 134. The xEventGroupSetBitsFromISR() API function prototype

Table 44, xEventGroupSetBitsFromISR() parameters and return value

Parameter Name	Description
xEventGroup	The handle of the event group in which bits are being set. The event group handle will have been returned from the call to xEventGroupCreate() used to create the event group.
uxBitsToSet	<p>A bit mask that specifies the event bit, or event bits, to set to 1 in the event group. The value of the event group is updated by bitwise ORing the event group's existing value with the value passed in uxBitsToSet.</p> <p>As an example, setting uxBitsToSet to 0x05 (binary 0101) will result in event bit 3 and event bit 0 in the event group becoming set (if they were not already set), while leaving all the other event bits in the event group unchanged.</p>

Table 44, xEventGroupSetBitsFromISR() parameters and return value

Parameter Name	Description
pxHigherPriorityTaskWoken	<p>xEventGroupSetBitsFromISR() does not set the event bits directly inside the interrupt service routine, but instead defers the action to the RTOS daemon task by sending a command on the timer command queue. If the daemon task was in the Blocked state to wait for data to become available on the timer command queue, then writing to the timer command queue will cause the daemon task to leave the Blocked state. If the priority of the daemon task is higher than the priority of the currently executing task (the task that was interrupted), then, internally, xEventGroupSetBitsFromISR() will set *pxHigherPriorityTaskWoken to pdTRUE.</p> <p>If xEventGroupSetBitsFromISR() sets this value to pdTRUE, then a context switch should be performed before the interrupt is exited. This will ensure that the interrupt returns directly to the daemon task, as the daemon task will be the highest priority Ready state task.</p>
Returned Value	<p>There are two possible return values:</p> <ol style="list-style-type: none"><li data-bbox="649 1239 812 1281">1. pdPASS <p>pdPASS will be returned only if data was successfully sent to the timer command queue.</p> <ol style="list-style-type: none"><li data-bbox="649 1449 812 1491">2. pdFALSE <p>pdFALSE will be returned if the 'set bits' command could not be written to the timer command queue because the queue was already full.</p>

The xEventGroupWaitBits() API Function

The xEventGroupWaitBits() API function allows a task to read the value of an event group, and optionally wait in the Blocked state for one or more event bits in the event group to become set, if the event bits are not already set.

```
EventBits_t xEventGroupWaitBits( const EventGroupHandle_t xEventGroup,  
                                const EventBits_t uxBitsToWaitFor,  
                                const BaseType_t xClearOnExit,  
                                const BaseType_t xWaitForAllBits,  
                                TickType_t xTicksToWait );
```

Listing 135. The xEventGroupWaitBits() API function prototype

The condition used by the scheduler to determine if a task will enter the Blocked state, and when a task will leave the Blocked state, is called the ‘unblock condition’. The unblock condition is specified by a combination of the uxBitsToWaitFor and the xWaitForAllBits parameter values:

- uxBitsToWaitFor specifies which event bits in the event group to test
- xWaitForAllBits specifies whether to use a bitwise OR test, or a bitwise AND test

A task will not enter the Blocked state if its unblock condition is met at the time xEventGroupWaitBits() is called.

Examples of conditions that will result in a task either entering the Blocked state, or exiting the Blocked state, are provided in Table 45. Table 45 only shows the least significant four binary bits of the event group and uxBitsToWaitFor values—the other bits of those two values are assumed to be zero.

Table 45, The Effect of the uxBitsToWaitFor and xWaitForAllBits Parameters			
Existing Event Group Value	uxBitsToWaitFor value	xWaitForAllBits value	Resultant Behavior
0000	0101	pdFALSE	The calling task will enter the Blocked state because neither of bit 0 or bit 2 are set in the event group, and will leave the Blocked state when either bit 0 OR bit 2 are set in the event group.

Table 45, The Effect of the uxBitsToWaitFor and xWaitForAllBits Parameters			
Existing Event Group Value	uxBitsToWaitFor value	xWaitForAllBits value	Resultant Behavior
0100	0101	pdTRUE	The calling task will enter the Blocked state because bit 0 and bit 2 are not both set in the event group, and will leave the Blocked state when both bit 0 AND bit 2 are set in the event group.
0100	0110	pdFALSE	The calling task will not enter the Blocked state because xWaitForAllBits is pdFALSE, and one of the two bits specified by uxBitsToWaitFor is already set in the event group.
0100	0110	pdTRUE	The calling task will enter the Blocked state because xWaitForAllBits is pdTRUE, and only one of the two bits specified by uxBitsToWaitFor is already set in the event group. The task will leave the Blocked state when both bit 2 and bit 3 are set in the event group.

The calling task specifies bits to test using the uxBitsToWaitFor parameter, and it is likely the calling task will need to clear these bits back to zero after its unblock condition has been met. Event bits can be cleared using the xEventGroupClearBits() API function, but using that function to manually clear event bits will lead to race conditions in the application code if:

- There is more than one task using the same event group.
- Bits are set in the event group by a different task, or by an interrupt service routine.

The xClearOnExit parameter is provided to avoid these potential race conditions. If xClearOnExit is set to pdTRUE, then the testing and clearing of event bits appears to the calling task to be an atomic operation (uninterruptable by other tasks or interrupts).

Table 46, xEventGroupWaitBits() parameters and return value

Parameter Name	Description
xEventGroup	The handle of the event group that contains the event bits being read. The event group handle will have been returned from the call to xEventGroupCreate() used to create the event group.
uxBitsToWaitFor	A bit mask that specifies the event bit, or event bits, to test in the event group. For example, if the calling task wants to wait for event bit 0 and/or event bit 2 to become set in the event group, then set uxBitsToWaitFor to 0x05 (binary 0101). Refer to Table 45 for further examples.
xClearOnExit	If the calling task's unblock condition has been met, and xClearOnExit is set to pdTRUE, then the event bits specified by uxBitsToWaitFor will be cleared back to 0 in the event group before the calling task exits the xEventGroupWaitBits() API function. If xClearOnExit is set to pdFALSE, then the state of the event bits in the event group are not modified by the xEventGroupWaitBits() API function.

Table 46, xEventGroupWaitBits() parameters and return value

Parameter Name	Description
xWaitForAllBits	<p>The uxBitsToWaitFor parameter specifies the event bits to test in the event group. xWaitForAllBits specifies if the calling task should be removed from the Blocked state when one or more of the events bits specified by the uxBitsToWaitFor parameter are set, or only when all of the event bits specified by the uxBitsToWaitFor parameter are set.</p> <p>If xWaitForAllBits is set to pdFALSE, then a task that entered the Blocked state to wait for its unblock condition to be met will leave the Blocked state when any of the bits specified by uxBitsToWaitFor become set (or the time out specified by the xTicksToWait parameter expires).</p> <p>If xWaitForAllBits is set to pdTRUE, then a task that entered the Blocked state to wait for its unblock condition to be met will only leave the Blocked state when all of the bits specified by uxBitsToWaitFor are set (or the time out specified by the xTicksToWait parameter expires).</p> <p>Refer to Table 45 for examples.</p>
xTicksToWait	<p>The maximum amount of time the task should remain in the Blocked state to wait for its unblock condition to be met.</p> <p>xEventGroupWaitBits() will return immediately if xTicksToWait is zero, or the unblock condition is met at the time xEventGroupWaitBits() is called.</p> <p>The block time is specified in tick periods, so the absolute time it represents is dependent on the tick frequency. The macro pdMS_TO_TICKS() can be used to convert a time specified in milliseconds into a time specified in ticks.</p> <p>Setting xTicksToWait to portMAX_DELAY will cause the task to wait indefinitely (without timing out), provided INCLUDE_vTaskSuspend is set to 1 in FreeRTOSConfig.h.</p>

Table 46, xEventGroupWaitBits() parameters and return value

Parameter Name	Description
Returned Value	<p>If xEventGroupWaitBits() returned because the calling task's unblock condition was met, then the returned value is the value of the event group at the time the calling task's unblock condition was met (before any bits were automatically cleared if xClearOnExit was pdTRUE). In this case the returned value will also meet the unblock condition.</p> <p>If xEventGroupWaitBits() returned because the block time specified by the xTicksToWait parameter expired, then the returned value is the value of the event group at the time the block time expired. In this case the returned value will not meet the unblock condition.</p>

Example 22. Experimenting with event groups

This example demonstrates how to:

- Create an event group.
- Set bits in an event group from an interrupt service routine.
- Set bits in an event group from a task.
- Block on an event group.

The effect of the xEventGroupWaitBits() xWaitForAllBits parameter is demonstrated by first executing the example with xWaitForAllBits set to pdFALSE, and then executing the example with xWaitForAllBits set to pdTRUE.

Event bit 0 and event bit 1 are set from a task. Event bit 2 is set from an interrupt service routine. These three bits are given descriptive names using the #define statements shown in Listing 136.

```
/* Definitions for the event bits in the event group. */
#define mainFIRST_TASK_BIT ( 1UL << 0UL ) /* Event bit 0, which is set by a task. */
#define mainSECOND_TASK_BIT ( 1UL << 1UL ) /* Event bit 1, which is set by a task. */
#define mainISR_BIT ( 1UL << 2UL ) /* Event bit 2, which is set by an ISR. */
```

Listing 136. Event bit definitions used in Example 22

Listing 137 shows the implementation of the task that sets event bit 0 and event bit 1. It sits in a loop, repeatedly setting one bit, then the other, with a delay of 200 milliseconds between each call to `xEventGroupSetBits()`. A string is printed out before each bit is set to allow the sequence of execution to be seen in the console.

```
static void vEventBitSettingTask( void *pvParameters )
{
    const TickType_t xDelay200ms = pdMS_TO_TICKS( 200UL ), xDontBlock = 0;

    for( ;; )
    {
        /* Delay for a short while before starting the next loop. */
        vTaskDelay( xDelay200ms );

        /* Print out a message to say event bit 0 is about to be set by the task,
        then set event bit 0. */
        vPrintString( "Bit setting task -\t about to set bit 0.\r\n" );
        xEventGroupSetBits( xEventGroup, mainFIRST_TASK_BIT );

        /* Delay for a short while before setting the other bit. */
        vTaskDelay( xDelay200ms );

        /* Print out a message to say event bit 1 is about to be set by the task,
        then set event bit 1. */
        vPrintString( "Bit setting task -\t about to set bit 1.\r\n" );
        xEventGroupSetBits( xEventGroup, mainSECOND_TASK_BIT );
    }
}
```

Listing 137. The task that sets two bits in the event group in Example 22

Listing 138 shows the implementation of the interrupt service routine that sets bit 2 in the event group. Again, a string is printed out before the bit is set to allow the sequence of execution to be seen in the console. In this case however, because console output should not be performed directly in an interrupt service routine, `xTimerPendFunctionCallFromISR()` is used to perform the output in the context of the RTOS daemon task.

As in previous examples, the interrupt service routine is triggered by a simple periodic task that forces a software interrupt. In this example, the interrupt is generated every 500 milliseconds.

```
static uint32_t ulEventBitSettingISR( void )
{
/* The string is not printed within the interrupt service routine, but is instead
sent to the RTOS daemon task for printing. It is therefore declared static to ensure
the compiler does not allocate the string on the stack of the ISR, as the ISR's stack
frame will not exist when the string is printed from the daemon task. */
static const char *pcString = "Bit setting ISR -\t about to set bit 2.\r\n";
 BaseType_t xHigherPriorityTaskWoken = pdFALSE;

/* Print out a message to say bit 2 is about to be set. Messages cannot be
printed from an ISR, so defer the actual output to the RTOS daemon task by
pending a function call to run in the context of the RTOS daemon task. */
xTimerPendFunctionCallFromISR( vPrintStringFromDaemonTask,
                               ( void * ) pcString,
                               0,
                               &xHigherPriorityTaskWoken );

/* Set bit 2 in the event group. */
xEventGroupSetBitsFromISR( xEventGroup, mainISR_BIT, &xHigherPriorityTaskWoken );

/* xTimerPendFunctionCallFromISR() and xEventGroupSetBitsFromISR() both write to
the timer command queue, and both used the same xHigherPriorityTaskWoken
variable. If writing to the timer command queue resulted in the RTOS daemon task
leaving the Blocked state, and if the priority of the RTOS daemon task is higher
than the priority of the currently executing task (the task this interrupt
interrupted) then xHigherPriorityTaskWoken will have been set to pdTRUE.

xHigherPriorityTaskWoken is used as the parameter to portYIELD_FROM_ISR(). If
xHigherPriorityTaskWoken equals pdTRUE, then calling portYIELD_FROM_ISR() will
request a context switch. If xHigherPriorityTaskWoken is still pdFALSE, then
calling portYIELD_FROM_ISR() will have no effect.

The implementation of portYIELD_FROM_ISR() used by the Windows port includes a
return statement, which is why this function does not explicitly return a
value. */
portYIELD_FROM_ISR( xHigherPriorityTaskWoken );
}
```

Listing 138. The ISR that sets bit 2 in the event group in Example 22

Listing 139 show the implementation of the task that calls xEventGroupWaitBits() to block on the event group. The task prints out a string for each bit that is set in the event group.

The xEventGroupWaitBits() xClearOnExit parameter is set to pdTRUE, so the event bit, or bits, that caused the call to xEventGroupWaitBits() to return will be cleared automatically before xEventGroupWaitBits() returns.

```

static void vEventBitReadingTask( void *pvParameters )
{
EventBits_t xEventGroupValue;
const EventBits_t xBitsToWaitFor = ( mainFIRST_TASK_BIT |
                                     mainSECOND_TASK_BIT |
                                     mainISR_BIT );

for( ;; )
{
    /* Block to wait for event bits to become set within the event group. */
    xEventGroupValue = xEventGroupWaitBits( /* The event group to read. */
                                           xEventGroup,

                                           /* Bits to test. */
                                           xBitsToWaitFor,

                                           /* Clear bits on exit if the
                                           unblock condition is met. */
                                           pdTRUE,

                                           /* Don't wait for all bits. This
                                           parameter is set to pdTRUE for the
                                           second execution. */
                                           pdFALSE,

                                           /* Don't time out. */
                                           portMAX_DELAY );

    /* Print a message for each bit that was set. */
    if( ( xEventGroupValue & mainFIRST_TASK_BIT ) != 0 )
    {
        vPrintString( "Bit reading task -\t Event bit 0 was set\r\n" );
    }

    if( ( xEventGroupValue & mainSECOND_TASK_BIT ) != 0 )
    {
        vPrintString( "Bit reading task -\t Event bit 1 was set\r\n" );
    }

    if( ( xEventGroupValue & mainISR_BIT ) != 0 )
    {
        vPrintString( "Bit reading task -\t Event bit 2 was set\r\n" );
    }
}
}

```

Listing 139. The task that blocks to wait for event bits to become set in Example 22

The main() function creates the event group, and the tasks, before starting the scheduler. See Listing 140 for its implementation. The priority of the task that reads from the event group is higher than the priority of the task that writes to the event group, ensuring the reading task will pre-empt the writing task each time the reading task's unblock condition is met.

```
int main( void )
{
    /* Before an event group can be used it must first be created. */
    xEventGroup = xEventGroupCreate();

    /* Create the task that sets event bits in the event group. */
    xTaskCreate( vEventBitSettingTask, "Bit Setter", 1000, NULL, 1, NULL );

    /* Create the task that waits for event bits to get set in the event group. */
    xTaskCreate( vEventBitReadingTask, "Bit Reader", 1000, NULL, 2, NULL );

    /* Create the task that is used to periodically generate a software interrupt. */
    xTaskCreate( vInterruptGenerator, "Int Gen", 1000, NULL, 3, NULL );

    /* Install the handler for the software interrupt. The syntax necessary to do
    this is dependent on the FreeRTOS port being used. The syntax shown here can
    only be used with the FreeRTOS Windows port, where such interrupts are only
    simulated. */
    vPortSetInterruptHandler( mainINTERRUPT_NUMBER, ulEventBitSettingISR );

    /* Start the scheduler so the created tasks start executing. */
    vTaskStartScheduler();

    /* The following line should never be reached. */
    for( ;; );
    return 0;
}
```

Listing 140. Creating the event group and tasks in Example 22

The output produced when Example 22 is executed with the `xEventGroupWaitBits()` `xWaitForAllBits` parameter set to `pdFALSE` is shown in Figure 73. In Figure 73, it can be seen that, because the `xWaitForAllBits` parameter in the call to `xEventGroupWaitBits()` was set to `pdFALSE`, the task that reads from the event group leaves the Blocked state and executes immediately every time any of the event bits are set.

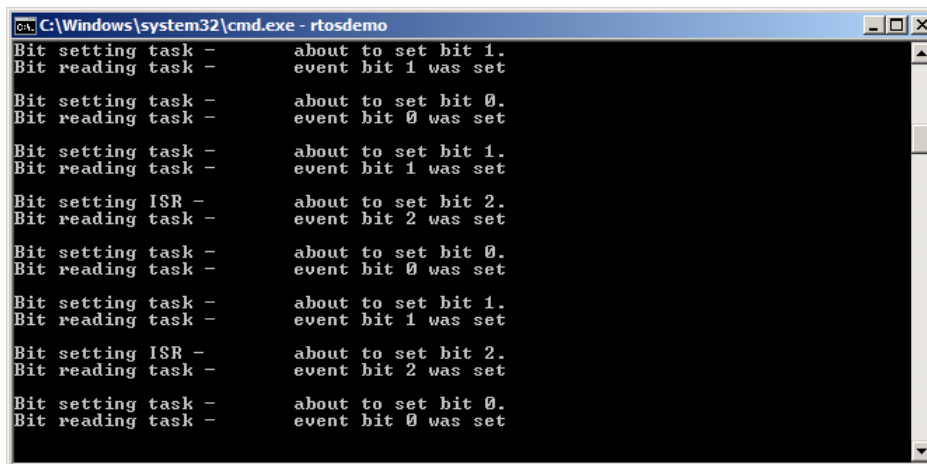

```
C:\Windows\system32\cmd.exe - rtsdemo
Bit setting task - about to set bit 1.
Bit reading task - event bit 1 was set
Bit setting task - about to set bit 0.
Bit reading task - event bit 0 was set
Bit setting task - about to set bit 1.
Bit reading task - event bit 1 was set
Bit setting ISR - about to set bit 2.
Bit reading task - event bit 2 was set
Bit setting task - about to set bit 0.
Bit reading task - event bit 0 was set
Bit setting task - about to set bit 1.
Bit reading task - event bit 1 was set
Bit setting ISR - about to set bit 2.
Bit reading task - event bit 2 was set
Bit setting task - about to set bit 0.
Bit reading task - event bit 0 was set
```

Figure 73 The output produced when Example 22 is executed with `xWaitForAllBits` set to `pdFALSE`

The output produced when Example 22 is executed with the `xEventGroupWaitBits()` `xWaitForAllBits` parameter set to `pdTRUE` is shown in Figure 74. In Figure 74 it can be seen that, because the `xWaitForAllBits` parameter was set to `pdTRUE`, the task that reads from the event group only leaves the Blocked state after all three of the event bits are set.

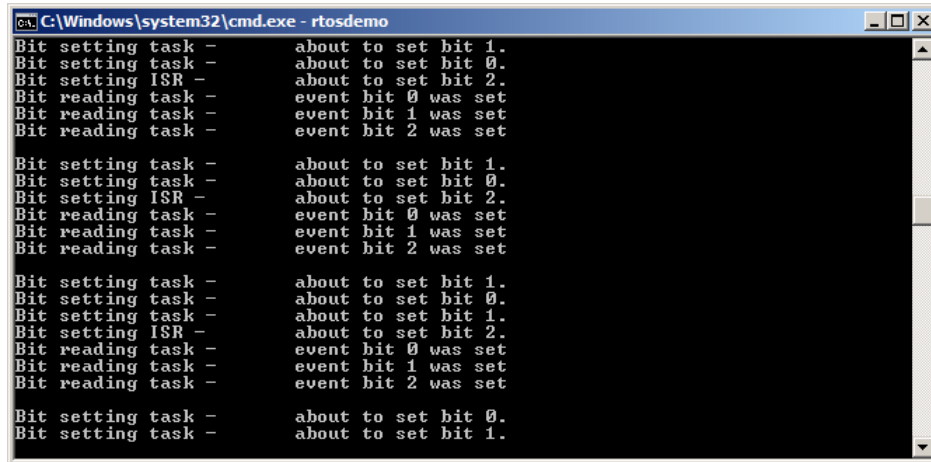

```
C:\Windows\system32\cmd.exe - rtosdemo
Bit setting task -      about to set bit 1.
Bit setting task -      about to set bit 0.
Bit setting ISR -       about to set bit 2.
Bit reading task -      event bit 0 was set
Bit reading task -      event bit 1 was set
Bit reading task -      event bit 2 was set

Bit setting task -      about to set bit 1.
Bit setting task -      about to set bit 0.
Bit setting ISR -       about to set bit 2.
Bit reading task -      event bit 0 was set
Bit reading task -      event bit 1 was set
Bit reading task -      event bit 2 was set

Bit setting task -      about to set bit 1.
Bit setting task -      about to set bit 0.
Bit setting task -      about to set bit 1.
Bit setting ISR -       about to set bit 2.
Bit reading task -      event bit 0 was set
Bit reading task -      event bit 1 was set
Bit reading task -      event bit 2 was set

Bit setting task -      about to set bit 0.
Bit setting task -      about to set bit 1.
```

Figure 74 The output produced when Example 22 is executed with `xWaitForAllBits` set to `pdTRUE`

8.4 Task Synchronization Using an Event Group

Sometimes the design of an application requires two or more tasks to synchronize with each other. For example, consider a design where Task A receives an event, then delegates some of the processing necessitated by the event to three other tasks: Task B, Task C and Task D. If Task A cannot receive another event until tasks B, C and D have all completed processing the previous event, then all four tasks will need to synchronize with each other. Each task's synchronization point will be after that task has completed its processing, and cannot proceed further until each of the other tasks have done the same. Task A can only receive another event after all four tasks have reached their synchronization point.

A less abstract example of the need for this type of task synchronization is found in one of the FreeRTOS+TCP demonstration projects. The demonstration shares a TCP socket between two tasks; one task sends data to the socket, and a different task receives data from the same socket¹. It is not safe for either task to close the TCP socket until it is sure the other task will not attempt to access the socket again. If either of the two tasks wishes to close the socket, then it must inform the other task of its intent, and then wait for the other task to stop using the socket before proceeding. The scenario where it is the task that sends data to the socket that wishes to close the socket is demonstrated by the pseudo code shown in Listing 140.

The scenario demonstrated by Listing 140 is trivial, as there are only two tasks that need to synchronize with each other, but it is easy to see how the scenario would become more complex, and require more tasks to join the synchronization, if other tasks were performing processing that was dependent on the socket being open.

¹ At the time of writing, this is the only way a single FreeRTOS+TCP socket can be shared between tasks.

```

void SocketTxTask( void *pvParameters )
{
xSocket_t xSocket;
uint32_t ulTxCount = 0UL;

    for( ;; )
    {
        /* Create a new socket. This task will send to this socket, and another task will receive
        from this socket. */
        xSocket = FreeRTOS_socket( ... );

        /* Connect the socket. */
        FreeRTOS_connect( xSocket, ... );

        /* Use a queue to send the socket to the task that receives data. */
        xQueueSend( xSocketPassingQueue, &xSocket, portMAX_DELAY );

        /* Send 1000 messages to the socket before closing the socket. */
        for( ulTxCount = 0; ulTxCount < 1000; ulTxCount++ )
        {
            if( FreeRTOS_send( xSocket, ... ) < 0 )
            {
                /* Unexpected error - exit the loop, after which the socket will be closed. */
                break;
            }
        }

        /* Let the Rx task know the Tx task wants to close the socket. */
        TxTaskWantsToCloseSocket();

        /* This is the Tx task's synchronization point. The Tx task waits here for the Rx task to
        reach its synchronization point. The Rx task will only reach its synchronization point
        when it is no longer using the socket, and the socket can be closed safely. */
        xEventGroupSync( ... );

        /* Neither task is using the socket. Shut down the connection, then close the socket. */
        FreeRTOS_shutdown( xSocket, ... );
        WaitForSocketToDisconnect();
        FreeRTOS_closesocket( xSocket );
    }
}
/*-----*/

void SocketRxTask( void *pvParameters )
{
xSocket_t xSocket;

    for( ;; )
    {
        /* Wait to receive a socket that was created and connected by the Tx task. */
        xQueueReceive( xSocketPassingQueue, &xSocket, portMAX_DELAY );

        /* Keep receiving from the socket until the Tx task wants to close the socket. */
        while( TxTaskWantsToCloseSocket() == pdFALSE )
        {
            /* Receive then process data. */
            FreeRTOS_recv( xSocket, ... );
            ProcessReceivedData();
        }

        /* This is the Rx task's synchronization point - it only reaches here when it is no longer
        using the socket, and it is therefore safe for the Tx task to close the socket. */
        xEventGroupSync( ... );
    }
}

```

Listing 141. Pseudo code for two tasks that synchronize with each other to ensure a shared TCP socket is no longer in use by either task before the socket is closed

An event group can be used to create a synchronization point:

- Each task that must participate in the synchronization is assigned a unique event bit within the event group.
- Each task sets its own event bit when it reaches the synchronization point.
- Having set its own event bit, each task blocks on the event group to wait for the event bits that represent all the other synchronizing tasks to also become set.

However, the `xEventGroupSetBits()` and `xEventGroupWaitBits()` API functions cannot be used in this scenario. If they were used, then the setting of a bit (to indicate a task had reached its synchronization point) and the testing of bits (to determine if the other synchronizing tasks had reached their synchronization point) would be performed as two separate operations. To see why that would be a problem, consider a scenario where Task A, Task B and Task C attempt to synchronize using an event group:

1. Task A and Task B have already reached the synchronization point, so their event bits are set in the event group, and they are in the Blocked state to wait for task C's event bit to also become set.
2. Task C reaches the synchronization point, and uses `xEventGroupSetBits()` to set its bit in the event group. As soon as Task C's bit is set, Task A and Task B leave the Blocked state, and clear all three event bits.
3. Task C then calls `xEventGroupWaitBits()` to wait for all three event bits to become set, but by that time, all three event bits have already been cleared, Task A and Task B have left their respective synchronization points, and so the synchronization has failed.

To successfully use an event group to create a synchronization point, the setting of an event bit, and the subsequent testing of event bits, must be performed as a single uninterruptable operation. The `xEventGroupSync()` API function is provided for that purpose.

The `xEventGroupSync()` API Function

`xEventGroupSync()` is provided to allow two or more tasks to use an event group to synchronize with each other. The function allows a task to set one or more event bits in an

event group, then wait for a combination of event bits to become set in the same event group, as a single uninterruptable operation.

The `xEventGroupSync()` `uxBitsToWaitFor` parameter specifies the calling task's unblock condition. The event bits specified by `uxBitsToWaitFor` will be cleared back to zero before `xEventGroupSync()` returns, if `xEventGroupSync()` returned because the unblock condition had been met.

```
EventBits_t xEventGroupSync( EventGroupHandle_t xEventGroup,  
                             const EventBits_t uxBitsToSet,  
                             const EventBits_t uxBitsToWaitFor,  
                             TickType_t xTicksToWait );
```

Listing 142. The `xEventGroupSync()` API function prototype

Table 47, `xEventGroupSync()` parameters and return value

Parameter Name	Description
<code>xEventGroup</code>	The handle of the event group in which event bits are to be set, and then tested. The event group handle will have been returned from the call to <code>xEventGroupCreate()</code> used to create the event group.
<code>uxBitsToSet</code>	A bit mask that specifies the event bit, or event bits, to set to 1 in the event group. The value of the event group is updated by bitwise ORing the event group's existing value with the value passed in <code>uxBitsToSet</code> . As an example, setting <code>uxBitsToSet</code> to 0x04 (binary 0100) will result in event bit 3 becoming set (if it was not already set), while leaving all the other event bits in the event group unchanged.
<code>uxBitsToWaitFor</code>	A bit mask that specifies the event bit, or event bits, to test in the event group. For example, if the calling task wants to wait for event bits 0, 1 and 2 to become set in the event group, then set <code>uxBitsToWaitFor</code> to 0x07 (binary 111).

Table 47, xEventGroupSync() parameters and return value

Parameter Name	Description
xTicksToWait	<p>The maximum amount of time the task should remain in the Blocked state to wait for its unblock condition to be met.</p> <p>xEventGroupSync() will return immediately if xTicksToWait is zero, or the unblock condition is met at the time xEventGroupSync() is called.</p> <p>The block time is specified in tick periods, so the absolute time it represents is dependent on the tick frequency. The macro pdMS_TO_TICKS() can be used to convert a time specified in milliseconds into a time specified in ticks.</p> <p>Setting xTicksToWait to portMAX_DELAY will cause the task to wait indefinitely (without timing out), provided INCLUDE_vTaskSuspend is set to 1 in FreeRTOSConfig.h.</p>
Returned Value	<p>If xEventGroupSync() returned because the calling task's unblock condition was met, then the returned value is the value of the event group at the time the calling task's unblock condition was met (before any bits were automatically cleared back to zero). In this case the returned value will also meet the calling task's unblock condition.</p> <p>If xEventGroupSync() returned because the block time specified by the xTicksToWait parameter expired, then the returned value is the value of the event group at the time the block time expired. In this case the returned value will not meet the calling task's unblock condition.</p>

Example 23. Synchronizing tasks

Example 23 uses xEventGroupSync() to synchronize three instances of a single task implementation. The task parameter is used to pass into each instance the event bit the task will set when it calls xEventGroupSync().

The task prints a message before calling xEventGroupSync(), and again after the call to xEventGroupSync() has returned. Each message includes a time stamp. This allows the

sequence of execution to be observed in the output produced. A pseudo random delay is used to prevent all the tasks reaching the synchronization point at the same time.

See Listing 143 for the task's implementation.

```
static void vSyncingTask( void *pvParameters )
{
const TickType_t xMaxDelay = pdMS_TO_TICKS( 4000UL );
const TickType_t xMinDelay = pdMS_TO_TICKS( 200UL );
TickType_t xDelayTime;
EventBits_t uxThisTasksSyncBit;
const EventBits_t uxAllSyncBits = ( mainFIRST_TASK_BIT |
                                     mainSECOND_TASK_BIT |
                                     mainTHIRD_TASK_BIT );

/* Three instances of this task are created - each task uses a different event
bit in the synchronization. The event bit to use is passed into each task
instance using the task parameter. Store it in the uxThisTasksSyncBit
variable. */
uxThisTasksSyncBit = ( EventBits_t ) pvParameters;

for( ;; )
{
/* Simulate this task taking some time to perform an action by delaying for a
pseudo random time. This prevents all three instances of this task reaching
the synchronization point at the same time, and so allows the example's
behavior to be observed more easily. */
xDelayTime = ( rand() % xMaxDelay ) + xMinDelay;
vTaskDelay( xDelayTime );

/* Print out a message to show this task has reached its synchronization
point. pcTaskGetTaskName() is an API function that returns the name assigned
to the task when the task was created. */
vPrintTwoStrings( pcTaskGetTaskName( NULL ), "reached sync point" );

/* Wait for all the tasks to have reached their respective synchronization
points. */
xEventGroupSync( /* The event group used to synchronize. */
                 xEventGroup,

                 /* The bit set by this task to indicate it has reached the
synchronization point. */
                 uxThisTasksSyncBit,

                 /* The bits to wait for, one bit for each task taking part
in the synchronization. */
                 uxAllSyncBits,

                 /* Wait indefinitely for all three tasks to reach the
synchronization point. */
                 portMAX_DELAY );

/* Print out a message to show this task has passed its synchronization
point. As an indefinite delay was used the following line will only be
executed after all the tasks reached their respective synchronization
points. */
vPrintTwoStrings( pcTaskGetTaskName( NULL ), "exited sync point" );
}
}
```

Listing 143. The implementation of the task used in Example 23

The main() function creates the event group, creates all three tasks, and then starts the scheduler. See Listing 144 for its implementation.

```
/* Definitions for the event bits in the event group. */
#define mainFIRST_TASK_BIT ( 1UL << 0UL ) /* Event bit 0, set by the first task. */
#define mainSECOND_TASK_BIT( 1UL << 1UL ) /* Event bit 1, set by the second task. */
#define mainTHIRD_TASK_BIT ( 1UL << 2UL ) /* Event bit 2, set by the third task. */

/* Declare the event group used to synchronize the three tasks. */
EventGroupHandle_t xEventGroup;

int main( void )
{
    /* Before an event group can be used it must first be created. */
    xEventGroup = xEventGroupCreate();

    /* Create three instances of the task. Each task is given a different name,
    which is later printed out to give a visual indication of which task is
    executing. The event bit to use when the task reaches its synchronization point
    is passed into the task using the task parameter. */
    xTaskCreate( vSyncingTask, "Task 1", 1000, mainFIRST_TASK_BIT, 1, NULL );
    xTaskCreate( vSyncingTask, "Task 2", 1000, mainSECOND_TASK_BIT, 1, NULL );
    xTaskCreate( vSyncingTask, "Task 3", 1000, mainTHIRD_TASK_BIT, 1, NULL );

    /* Start the scheduler so the created tasks start executing. */
    vTaskStartScheduler();

    /* As always, the following line should never be reached. */
    for( ;; );
    return 0;
}
```

Listing 144. The main() function used in Example 23

The output produced when Example 23 is executed is shown in Figure 75. It can be seen that, even though each task reaches the synchronization point at a different (pseudo random) time, each task exits the synchronization point at the same time¹ (which is the time at which the last task reached the synchronization point).

¹ Figure 75 shows the example running in the FreeRTOS Windows port, which does not provide true real time behavior (especially when using Windows system calls to print to the console), and will therefore show some timing variation.

```
C:\Windows\system32\cmd.exe - rtosdemo
At time 211664: Task 1 reached sync point
At time 211664: Task 1 exited sync point
At time 211664: Task 2 exited sync point
At time 211664: Task 3 exited sync point
At time 212702: Task 2 reached sync point
At time 214400: Task 1 reached sync point
At time 215439: Task 3 reached sync point
At time 215439: Task 3 exited sync point
At time 215439: Task 2 exited sync point
At time 215440: Task 1 exited sync point
At time 217671: Task 2 reached sync point
At time 218622: Task 1 reached sync point
At time 219402: Task 3 reached sync point
At time 219402: Task 3 exited sync point
At time 219402: Task 2 exited sync point
At time 219402: Task 1 exited sync point
At time 220189: Task 2 reached sync point
At time 222656: Task 3 reached sync point
At time 222673: Task 1 reached sync point
At time 222673: Task 1 exited sync point
At time 222673: Task 2 exited sync point
At time 222673: Task 3 exited sync point
At time 223252: Task 1 reached sync point
At time 223682: Task 3 reached sync point
```

Figure 75 The output produced when Example 23 is executed

Chapter 9

Task Notifications

9.1 Chapter Introduction and Scope

It has been seen that applications that use FreeRTOS are structured as a set of independent tasks, and that it is likely that these autonomous tasks will have to communicate with each other so that, collectively, they can provide useful system functionality.

Communicating Through Intermediary Objects

This book has already described various ways in which tasks can communicate with each other. The methods described so far have required the creation of a communication object. Examples of communication objects include queues, event groups, and various different types of semaphore.

When a communication object is used, events and data are not sent directly to a receiving task, or a receiving ISR, but are instead sent to the communication object. Likewise, tasks and ISRs receive events and data from the communication object, rather than directly from the task or ISR that sent the event or data. This is depicted in Figure 76.

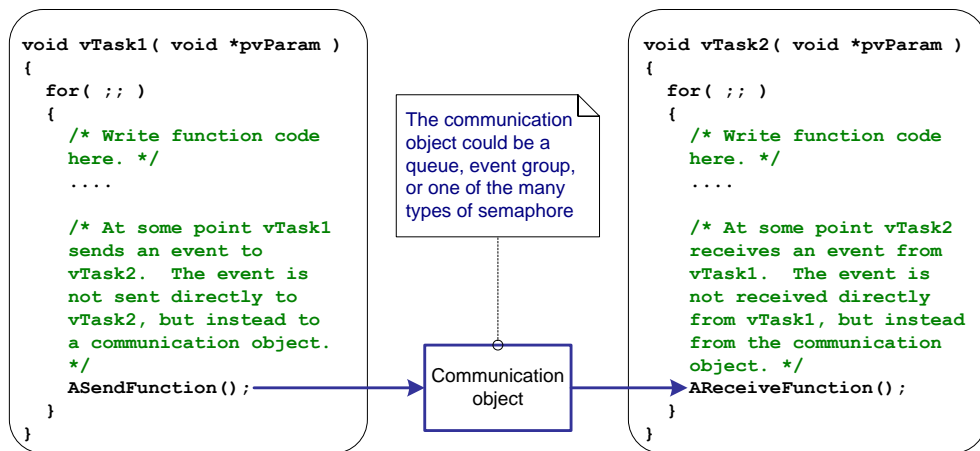

Figure 76 A communication object being used to send an event from one task to another

Task Notifications—Direct to Task Communication

'Task Notifications' allow tasks to interact with other tasks, and to synchronize with ISRs, without the need for a separate communication object. By using a task notification, a task or ISR can send an event directly to the receiving task. This is depicted in Figure 77.

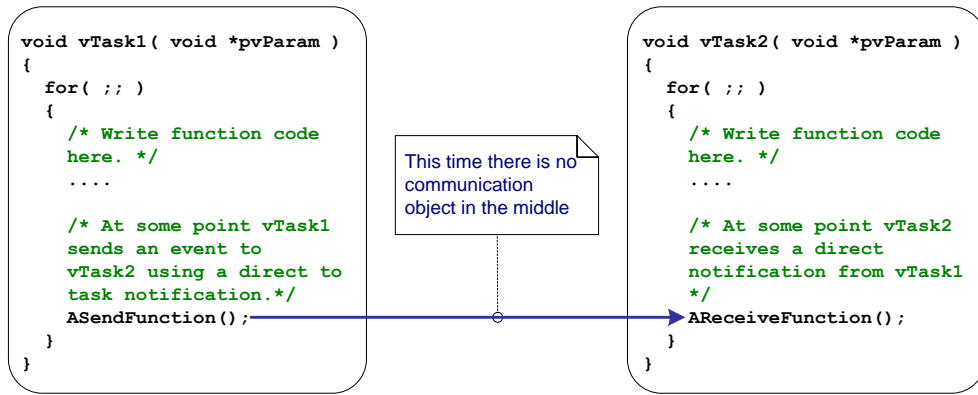

Figure 77 A task notification used to send an event directly from one task to another

Task notification functionality is optional. To include task notification functionality set configUSE_TASK_NOTIFICATIONS to 1 in FreeRTOSConfig.h.

When configUSE_TASK_NOTIFICATIONS is set to 1, each task has a 'Notification State', which can be either 'Pending' or 'Not-Pending', and a 'Notification Value', which is a 32-bit unsigned integer. When a task receives a notification, its notification state is set to pending. When a task reads its notification value, its notification state is set to not-pending.

A task can wait in the Blocked state, with an optional time out, for its notification state to become pending.

Scope

This chapter aims to give readers a good understanding of:

- A task's notification state and notification value.
- How and when a task notification can be used in place of a communication object, such as a semaphore.
- The advantages of using a task notification in place of a communication object.

9.2 Task Notifications; Benefits and Limitations

Performance Benefits of Task Notifications

Using a task notification to send an event or data to a task is significantly faster than using a queue, semaphore or event group to perform an equivalent operation.

RAM Footprint Benefits of Task Notifications

Likewise, using a task notification to send an event or data to a task requires significantly less RAM than using a queue, semaphore or event group to perform an equivalent operation. This is because each communication object (queue, semaphore or event group) must be created before it can be used, whereas enabling task notification functionality has a fixed overhead of just eight bytes of RAM per task.

Limitations of Task Notifications

Task notifications are faster and use less RAM than communication objects, but task notifications cannot be used in all scenarios. This section documents the scenarios in which a task notification cannot be used:

- Sending an event or data to an ISR

Communication objects can be used to send events and data from an ISR to a task, and from a task to an ISR.

Task notifications can be used to send events and data from an ISR to a task, but they cannot be used to send events or data from a task to an ISR.

- Enabling more than one receiving task

A communication object can be accessed by any task or ISR that knows its handle (which might be a queue handle, semaphore handle, or event group handle). Any number of tasks and ISRs can process events or data sent to any given communication object.

Task notifications are sent directly to the receiving task, so can only be processed by the task to which the notification is sent. However, this is rarely a limitation in practical cases because, while it is common to have multiple tasks and ISRs sending to the same

communication object, it is rare to have multiple tasks and ISRs receiving from the same communication object.

- Buffering multiple data items

A queue is a communication object that can hold more than one data item at a time. Data that has been sent to the queue, but not yet received from the queue, is buffered inside the queue object.

Task notifications send data to a task by updating the receiving task's notification value. A task's notification value can only hold one value at a time.

- Broadcasting to more than one task

An event group is a communication object that can be used to send an event to more than one task at a time.

Task notifications are sent directly to the receiving task, so can only be processed by the receiving task.

- Waiting in the blocked state for a send to complete

If a communication object is temporarily in a state that means no more data or events can be written to it (for example, when a queue is full no more data can be sent to the queue), then tasks attempting to write to the object can optionally enter the Blocked state to wait for their write operation to complete.

If a task attempts to send a task notification to a task that already has a notification pending, then it is not possible for the sending task to wait in the Blocked state for the receiving task to reset its notification state. As will be seen, this is rarely a limitation in practical cases in which a task notification is used.

9.3 Using Task Notifications

Task Notification API Options

Task notifications are a very powerful feature that can often be used in place of a binary semaphore, a counting semaphore, an event group, and sometimes even a queue. This wide range of usage scenarios can be achieved by using the `xTaskNotify()` API function to send a task notification, and the `xTaskNotifyWait()` API function to receive a task notification.

However, in the majority of cases, the full flexibility provided by the `xTaskNotify()` and `xTaskNotifyWait()` API functions is not required, and simpler functions would suffice. Therefore, the `xTaskNotifyGive()` API function is provided as a simpler but less flexible alternative to `xTaskNotify()`, and the `ulTaskNotifyTake()` API function is provided as a simpler but less flexible alternative to `xTaskNotifyWait()`.

The `xTaskNotifyGive()` API Function

`xTaskNotifyGive()` sends a notification directly to a task, and increments (adds one to) the receiving task's notification value. Calling `xTaskNotifyGive()` will set the receiving task's notification state to pending, if it was not already pending.

The `xTaskNotifyGive()`¹ API function is provided to allow a task notification to be used as a lighter weight and faster alternative to a binary or counting semaphore.

```
 BaseType_t xTaskNotifyGive( TaskHandle_t xTaskToNotify );
```

Listing 145. The `xTaskNotifyGive()` API function prototype

¹ `xTaskNotifyGive()` is actually implemented as macro, not a function. For simplicity it is referred to as a function throughout this book.

Table 48. xTaskNotifyGive() parameters and return value

Parameter Name/ Returned Value	Description
xTaskToNotify	The handle of the task to which the notification is being sent—see the pxCreatedTask parameter of the xTaskCreate() API function for information on obtaining handles to tasks.
Returned value	xTaskNotifyGive() is a macro that calls xTaskNotify(). The parameters passed into xTaskNotify() by the macro are set such that pdPASS is the only possible return value. xTaskNotify() is described later in this book.

The vTaskNotifyGiveFromISR() API Function

vTaskNotifyGiveFromISR() is a version of xTaskNotifyGive() that can be used in an interrupt service routine.

```
void vTaskNotifyGiveFromISR( TaskHandle_t xTaskToNotify,  
                             BaseType_t *pxHigherPriorityTaskWoken );
```

Listing 146. The vTaskNotifyGiveFromISR() API function prototype

Table 49. vTaskNotifyGiveFromISR() parameters and return value

Parameter Name/ Returned Value	Description
xTaskToNotify	The handle of the task to which the notification is being sent—see the pxCreatedTask parameter of the xTaskCreate() API function for information on obtaining handles to tasks.

Table 49. vTaskNotifyGiveFromISR() parameters and return value

Parameter Name/ Returned Value	Description
pxHigherPriorityTaskWoken	<p>If the task to which the notification is being sent is waiting in the Blocked state to receive a notification, then sending the notification will cause the task to leave the Blocked state.</p> <p>If calling vTaskNotifyGiveFromISR() causes a task to leave the Blocked state, and the unblocked task has a priority higher than the priority of the currently executing task (the task that was interrupted), then, internally, vTaskNotifyGiveFromISR() will set *pxHigherPriorityTaskWoken to pdTRUE.</p> <p>If vTaskNotifyGiveFromISR() sets this value to pdTRUE, then a context switch should be performed before the interrupt is exited. This will ensure that the interrupt returns directly to the highest priority Ready state task.</p> <p>As with all interrupt safe API functions, the pxHigherPriorityTaskWoken parameter must be set to pdFALSE before it is used.</p>

The ulTaskNotifyTake() API Function

ulTaskNotifyTake() allows a task to wait in the Blocked state for its notification value to be greater than zero, and either decrements (subtracts one from) or clears the task's notification value before it returns.

The ulTaskNotifyTake() API function is provided to allow a task notification to be used as a lighter weight and faster alternative to a binary or counting semaphore.

```
uint32_t ulTaskNotifyTake( BaseType_t xClearCountOnExit, TickType_t xTicksToWait );
```

Listing 147. The ulTaskNotifyTake() API function prototype

Table 50. ulTaskNotifyTake() parameters and return value

Parameter Name/ Returned Value	Description
xClearCountOnExit	<p>If xClearCountOnExit is set to pdTRUE, then the calling task's notification value will be cleared to zero before the call to ulTaskNotifyTake() returns.</p> <p>If xClearCountOnExit is set to pdFALSE, and the calling task's notification value is greater than zero, then the calling task's notification value will be decremented before the call to ulTaskNotifyTake() returns.</p>
xTicksToWait	<p>The maximum amount of time the calling task should remain in the Blocked state to wait for its notification value to be greater than zero.</p> <p>The block time is specified in tick periods, so the absolute time it represents is dependent on the tick frequency. The macro pdMS_TO_TICKS() can be used to convert a time specified in milliseconds to a time specified in ticks.</p> <p>Setting xTicksToWait to portMAX_DELAY will cause the task to wait indefinitely (without timing out), provided INCLUDE_vTaskSuspend is set to 1 in FreeRTOSConfig.h.</p>

Table 50. ulTaskNotifyTake() parameters and return value

Parameter Name/ Returned Value	Description
Returned value	<p>The returned value is the calling task's notification value <i>before</i> it was either cleared to zero or decremented, as specified by the value of the xClearCountOnExit parameter.</p> <p>If a block time was specified (xTicksToWait was not zero), and the return value is not zero, then it is possible the calling task was placed into the Blocked state, to wait for its notification value to be greater than zero, and its notification value was updated before the block time expired.</p> <p>If a block time was specified (xTicksToWait was not zero), and the return value is zero, then the calling task was placed into the Blocked state, to wait for its notification value to be greater than zero, but the specified block time expired before that happened.</p>

Example 24. Using a task notification in place of a semaphore, method 1

Example 16 used a binary semaphore to unblock a task from within an interrupt service routine—effectively synchronizing the task with the interrupt. This example replicates the functionality of Example 16, but uses a direct to task notification in place of the binary semaphore.

Listing 148 shows the implementation of the task that is synchronized with the interrupt. The call to xSemaphoreTake() that was used in Example 16 has been replaced by a call to ulTaskNotifyTake().

The ulTaskNotifyTake() xClearCountOnExit parameter is set to pdTRUE, which results in the receiving task's notification value being cleared to zero before ulTaskNotifyTake() returns. It is therefore necessary to process all the events that are already available between each call to ulTaskNotifyTake(). In Example 16, because a binary semaphore was used, the number of pending events had to be determined from the hardware, which is not always practical. In Example 24, the number of pending events is returned from ulTaskNotifyTake().

Interrupt events that occur between calls to `ulTaskNotifyTake` are latched in the task's notification value, and calls to `ulTaskNotifyTake()` will return immediately if the calling task already has notifications pending.

```
/* The rate at which the periodic task generates software interrupts. */
const TickType_t xInterruptFrequency = pdMS_TO_TICKS( 500UL );

static void vHandlerTask( void *pvParameters )
{
    /* xMaxExpectedBlockTime is set to be a little longer than the maximum expected time
    between events. */
    const TickType_t xMaxExpectedBlockTime = xInterruptFrequency + pdMS_TO_TICKS( 10 );
    uint32_t ulEventsToProcess;

    /* As per most tasks, this task is implemented within an infinite loop. */
    for( ;; )
    {
        /* Wait to receive a notification sent directly to this task from the
        interrupt service routine. */
        ulEventsToProcess = ulTaskNotifyTake( pdTRUE, xMaxExpectedBlockTime );
        if( ulEventsToProcess != 0 )
        {
            /* To get here at least one event must have occurred. Loop here until
            all the pending events have been processed (in this case, just print out
            a message for each event). */
            while( ulEventsToProcess > 0 )
            {
                vPrintString( "Handler task - Processing event.\r\n" );
                ulEventsToProcess--;
            }
        }
        else
        {
            /* If this part of the function is reached then an interrupt did not
            arrive within the expected time, and (in a real application) it may be
            necessary to perform some error recovery operations. */
        }
    }
}
```

Listing 148. The implementation of the task to which the interrupt processing is deferred (the task that synchronizes with the interrupt) in Example 24

The periodic task used to generate software interrupts prints a message before the interrupt is generated, and again after the interrupt has been generated. This allows the sequence of execution to be observed in the output produced.

Listing 149 shows the interrupt handler. This does very little other than send a notification directly to the task to which interrupt handling is deferred.

```

static uint32_t ulExampleInterruptHandler( void )
{
BaseType_t xHigherPriorityTaskWoken;

/* The xHigherPriorityTaskWoken parameter must be initialized to pdFALSE as
it will get set to pdTRUE inside the interrupt safe API function if a
context switch is required. */
xHigherPriorityTaskWoken = pdFALSE;

/* Send a notification directly to the task to which interrupt processing is
being deferred. */
vTaskNotifyGiveFromISR( /* The handle of the task to which the notification
is being sent. The handle was saved when the task
was created. */
xHandlerTask,

/* xHigherPriorityTaskWoken is used in the usual
way. */
&xHigherPriorityTaskWoken );

/* Pass the xHigherPriorityTaskWoken value into portYIELD_FROM_ISR(). If
xHigherPriorityTaskWoken was set to pdTRUE inside vTaskNotifyGiveFromISR()
then calling portYIELD_FROM_ISR() will request a context switch. If
xHigherPriorityTaskWoken is still pdFALSE then calling
portYIELD_FROM_ISR() will have no effect. The implementation of
portYIELD_FROM_ISR() used by the Windows port includes a return statement,
which is why this function does not explicitly return a value. */
portYIELD_FROM_ISR( xHigherPriorityTaskWoken );
}

```

Listing 149. The implementation of the interrupt service routine used in Example 24

The output produced when Example 24 is executed is shown in Figure 78. As expected, it is identical to that produced when Example 16 is executed. `vHandlerTask()` enters the Running state as soon as the interrupt is generated, so the output from the task splits the output produced by the periodic task. Further explanation is provided in Figure 79.

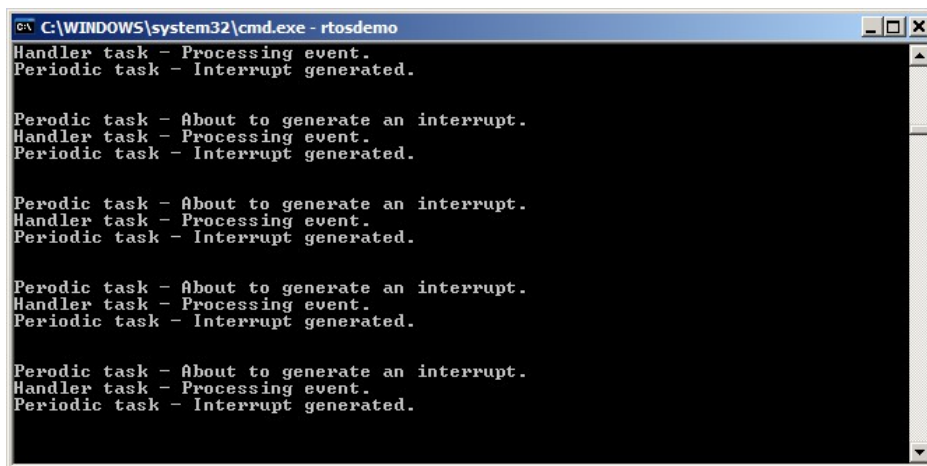

Figure 78. The output produced when Example 16 is executed

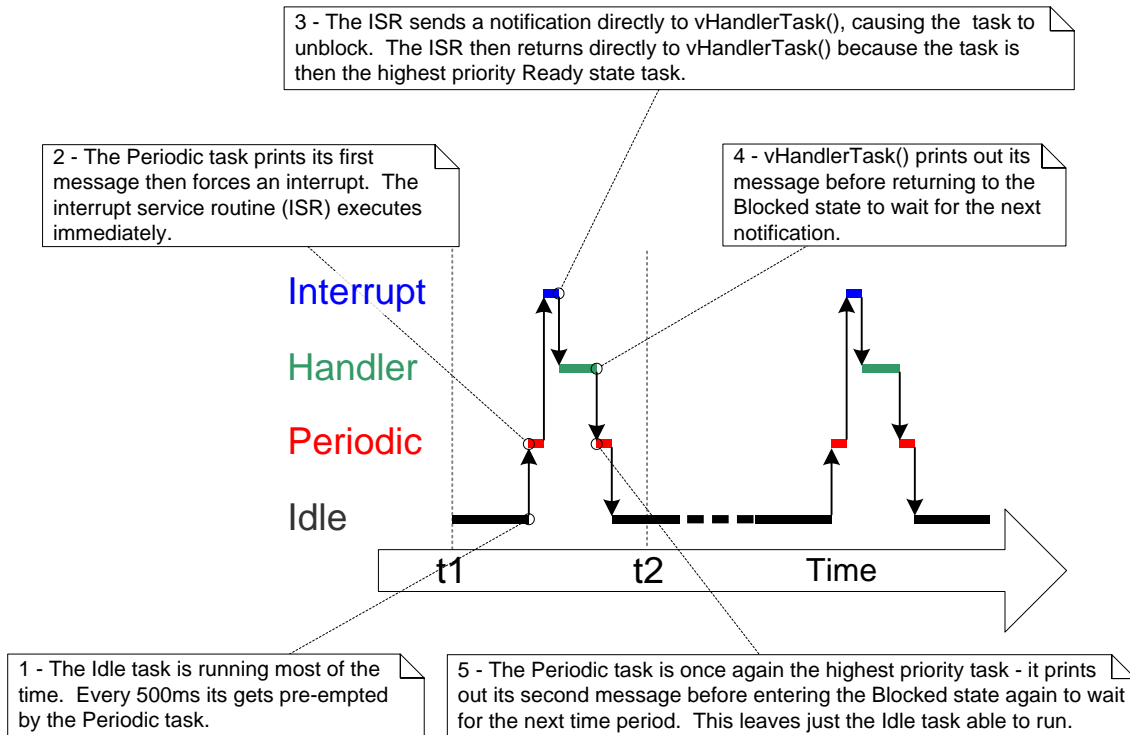

Figure 79. The sequence of execution when Example 24 is executed

Example 25. Using a task notification in place of a semaphore, method 2

In Example 24, the `ulTaskNotifyTake()` `xClearOnExit` parameter was set to `pdTRUE`. Example 25 modifies Example 24 slightly to demonstrate the behavior when the `ulTaskNotifyTake()` `xClearOnExit` parameter is instead set to `pdFALSE`.

When `xClearOnExit` is `pdFALSE`, calling `ulTaskNotifyTake()` will only decrement (reduce by one) the calling task's notification value, instead of clearing it to zero. The notification count is therefore the difference between the number of events that have occurred, and the number of events that have been processed. That allows the structure of `vHandlerTask()` to be simplified in two ways:

1. The number of events waiting to be processed is held in the notification value, so it does not need to be held in a local variable.
2. It is only necessary to process one event between each call to `ulTaskNotifyTake()`.

The implementation of `vHandlerTask()` used in Example 25 is shown in Listing 150.

```

static void vHandlerTask( void *pvParameters )
{
/* xMaxExpectedBlockTime is set to be a little longer than the maximum expected time
between events. */
const TickType_t xMaxExpectedBlockTime = xInterruptFrequency + pdMS_TO_TICKS( 10 );

/* As per most tasks, this task is implemented within an infinite loop. */
for( ;; )
{
/* Wait to receive a notification sent directly to this task from the
interrupt service routine. The xClearCountOnExit parameter is now pdFALSE,
so the task's notification value will be decremented by ulTaskNotifyTake(),
and not cleared to zero. */
if( ulTaskNotifyTake( pdFALSE, xMaxExpectedBlockTime ) != 0 )
{
/* To get here an event must have occurred. Process the event (in this
case just print out a message). */
vPrintString( "Handler task - Processing event.\r\n" );
}
else
{
/* If this part of the function is reached then an interrupt did not
arrive within the expected time, and (in a real application) it may be
necessary to perform some error recovery operations. */
}
}
}
}

```

Listing 150. The implementation of the task to which the interrupt processing is deferred (the task that synchronizes with the interrupt) in Example 25

For demonstration purposes, the interrupt service routine has also been modified to send more than one task notification per interrupt, and in so doing, simulate multiple interrupts occurring at high frequency. The implementation of the interrupt service routine used in Example 25 is shown in Listing 151.

```

static uint32_t ulExampleInterruptHandler( void )
{
BaseType_t xHigherPriorityTaskWoken;

xHigherPriorityTaskWoken = pdFALSE;

/* Send a notification to the handler task multiple times. The first 'give' will
unblock the task, the following 'gives' are to demonstrate that the receiving
task's notification value is being used to count (latch) events - allowing the
task to process each event in turn. */
vTaskNotifyGiveFromISR( xHandlerTask, &xHigherPriorityTaskWoken );
vTaskNotifyGiveFromISR( xHandlerTask, &xHigherPriorityTaskWoken );
vTaskNotifyGiveFromISR( xHandlerTask, &xHigherPriorityTaskWoken );

portYIELD_FROM_ISR( xHigherPriorityTaskWoken );
}

```

Listing 151. The implementation of the interrupt service routine used in Example 25

The output produced when Example 25 is executed is shown in Figure 80. As can be seen, vHandlerTask() processes all three events each time an interrupt is generated.

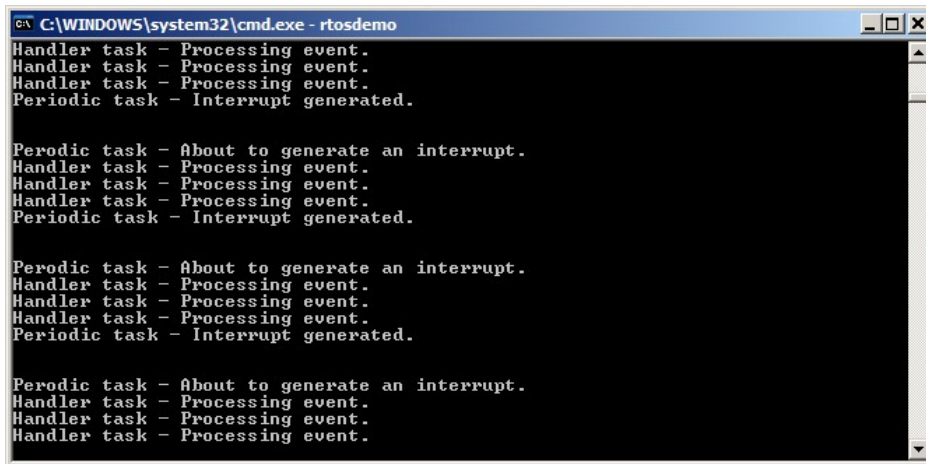

```
C:\WINDOWS\system32\cmd.exe - rtdemo
Handler task - Processing event.
Handler task - Processing event.
Handler task - Processing event.
Periodic task - Interrupt generated.

Perodic task - About to generate an interrupt.
Handler task - Processing event.
Handler task - Processing event.
Handler task - Processing event.
Periodic task - Interrupt generated.

Perodic task - About to generate an interrupt.
Handler task - Processing event.
Handler task - Processing event.
Handler task - Processing event.
Periodic task - Interrupt generated.

Perodic task - About to generate an interrupt.
Handler task - Processing event.
Handler task - Processing event.
Handler task - Processing event.
```

Figure 80. The output produced when Example 25 is executed

The xTaskNotify() and xTaskNotifyFromISR() API Functions

xTaskNotify() is a more capable version of xTaskNotifyGive() that can be used to update the receiving task's notification value in any of the following ways:

- Increment (add one to) the receiving task's notification value, in which case xTaskNotify() is equivalent to xTaskNotifyGive().
- Set one or more bits in the receiving task's notification value. This allows a task's notification value to be used as a lighter weight and faster alternative to an event group.
- Write a completely new number into the receiving task's notification value, but only if the receiving task has read its notification value since it was last updated. This allows a task's notification value to provide similar functionality to that provided by a queue that has a length of one.
- Write a completely new number into the receiving task's notification value, even if the receiving task has not read its notification value since it was last updated. This allows a task's notification value to provide similar functionality to that provided by the xQueueOverwrite() API function. The resultant behavior is sometimes referred to as a 'mailbox'.

xTaskNotify() is more flexible and powerful than xTaskNotifyGive(), and because of that extra flexibility and power, it is also a little more complex to use.

xTaskNotifyFromISR() is a version of xTaskNotify() that can be used in an interrupt service routine, and therefore has an additional pxHigherPriorityTaskWoken parameter.

Calling xTaskNotify() will always set the receiving task's notification state to pending, if it was not already pending.

```

BaseType_t xTaskNotify( TaskHandle_t xTaskToNotify,
                        uint32_t ulValue,
                        eNotifyAction eAction );

BaseType_t xTaskNotifyFromISR( TaskHandle_t xTaskToNotify,
                               uint32_t ulValue,
                               eNotifyAction eAction,
                               BaseType_t *pxHigherPriorityTaskWoken );

```

Listing 152. Prototypes for the xTaskNotify() and xTaskNotifyFromISR() API functions

Table 51. xTaskNotify() parameters and return value

Parameter Name/ Returned Value	Description
xTaskToNotify	The handle of the task to which the notification is being sent—see the pxCreatedTask parameter of the xTaskCreate() API function for information on obtaining handles to tasks.
ulValue	How ulValue is used is dependent on the eNotifyAction value. See Table 52.
eNotifyAction	An enumerated type that specifies how to update the receiving task's notification value. See Table 52.
Returned value	xTaskNotify() will return pdPASS <i>except</i> in the one case noted in Table 52.

Table 52. Valid xTaskNotify() eNotifyAction Parameter Values, and Their Resultant Effect on the Receiving Task's Notification Value

eNotifyAction Value	Resultant Effect on Receiving Task
eNoAction	<p>The receiving task's notification state is set to pending without it's notification value being updated. The xTaskNotify() ulValue parameter is not used.</p> <p>The eNoAction action allows a task notification to be used as a faster and lighter weight alternative to a binary semaphore.</p>
eSetBits	<p>The receiving task's notification value is bitwise OR'ed with the value passed in the xTaskNotify() ulValue parameter. For example, if ulValue is set to 0x01, then bit 0 will be set in the receiving task's notification value. As another example, if ulValue is 0x06 (binary 0110) then bit 1 and bit 2 will be set in the receiving task's notification value.</p> <p>The eSetBits action allows a task notification to be used as a faster and lighter weight alternative to an event group.</p>
eIncrement	<p>The receiving task's notification value is incremented. The xTaskNotify() ulValue parameter is not used.</p> <p>The eIncrement action allows a task notification to be used as a faster and lighter weight alternative to a binary or counting semaphore, and is equivalent to the simpler xTaskNotifyGive() API function.</p>
eSetValueWithoutOverwrite	<p>If the receiving task had a notification pending before xTaskNotify() was called, then no action is taken and xTaskNotify() will return pdFAIL.</p> <p>If the receiving task did not have a notification pending before xTaskNotify() was called, then the receiving task's notification value is set to the value passed in the xTaskNotify() ulValue parameter.</p>

Table 51. xTaskNotify() parameters and return value

Parameter Name/ Returned Value	Description
eSetValueWithOverwrite	The receiving task's notification value is set to the value passed in the xTaskNotify() ulValue parameter, regardless of whether the receiving task had a notification pending before xTaskNotify() was called or not.

The xTaskNotifyWait() API Function

xTaskNotifyWait() is a more capable version of ulTaskNotifyTake(). It allows a task to wait, with an optional timeout, for the calling task's notification state to become pending, should it not already be pending. xTaskNotifyWait() provides options for bits to be cleared in the calling task's notification value both on entry to the function, and on exit from the function.

```

BaseType_t xTaskNotifyWait( uint32_t ulBitsToClearOnEntry,
                           uint32_t ulBitsToClearOnExit,
                           uint32_t *pulNotificationValue,
                           TickType_t xTicksToWait );

```

Listing 153. The xTaskNotifyWait() API function prototype

Table 53. xTaskNotifyWait() parameters and return value

Parameter Name/ Returned Value	Description
ulBitsToClearOnEntry	<p>If the calling task did not have a notification pending before it called xTaskNotifyWait(), then any bits set in ulBitsToClearOnEntry will be cleared in the task's notification value on entry to the function.</p> <p>For example, if ulBitsToClearOnEntry is 0x01, then bit 0 of the task's notification value will be cleared. As another example, setting ulBitsToClearOnEntry to 0xffffffff (ULONG_MAX) will clear all the bits in the task's notification value, effectively clearing the value to 0.</p>

Table 53. xTaskNotifyWait() parameters and return value

Parameter Name/ Returned Value	Description
ulBitsToClearOnExit	<p>If the calling task exits xTaskNotifyWait() because it received a notification, or because it already had a notification pending when xTaskNotifyWait() was called, then any bits set in ulBitsToClearOnExit will be cleared in the task's notification value before the task exits the xTaskNotifyWait() function.</p> <p>The bits are cleared after the task's notification value has been saved in *pulNotificationValue (see the description of pulNotificationValue below).</p> <p>For example, if ulBitsToClearOnExit is 0x03, then bit 0 and bit 1 of the task's notification value will be cleared before the function exits.</p> <p>Setting ulBitsToClearOnExit to 0xffffffff (ULONG_MAX) will clear all the bits in the task's notification value, effectively clearing the value to 0.</p>
pulNotificationValue	<p>Used to pass out the task's notification value. The value copied to *pulNotificationValue is the task's notification value as it was before any bits were cleared due to the ulBitsToClearOnExit setting.</p> <p>pulNotificationValue is an optional parameter and can be set to NULL if it is not required.</p>

Table 53. xTaskNotifyWait() parameters and return value

Parameter Name/ Returned Value	Description
xTicksToWait	<p>The maximum amount of time the calling task should remain in the Blocked state to wait for its notification state to become pending.</p> <p>The block time is specified in tick periods, so the absolute time it represents is dependent on the tick frequency. The macro <code>pdMS_TO_TICKS()</code> can be used to convert a time specified in milliseconds to a time specified in ticks.</p> <p>Setting <code>xTicksToWait</code> to <code>portMAX_DELAY</code> will cause the task to wait indefinitely (without timing out), provided <code>INCLUDE_vTaskSuspend</code> is set to 1 in <code>FreeRTOSConfig.h</code>.</p>

Table 53. xTaskNotifyWait() parameters and return value

Parameter Name/ Returned Value	Description
Returned value	<p>There are two possible return values:</p> <ol style="list-style-type: none"><li data-bbox="605 411 764 443">1. pdTRUE <p>This indicates xTaskNotifyWait() returned because a notification was received, or because the calling task already had a notification pending when xTaskNotifyWait() was called.</p> <p>If a block time was specified (xTicksToWait was not zero), then it is possible that the calling task was placed into the Blocked state, to wait for its notification state to become pending, but its notification state was set to pending before the block time expired.</p> <ol style="list-style-type: none"><li data-bbox="605 1010 777 1041">2. pdFALSE <p>This indicates that xTaskNotifyWait() returned without the calling task receiving a task notification.</p> <p>If xTicksToWait was not zero then the calling task will have been held in the Blocked state to wait for its notification state to become pending, but the specified block time expired before that happened.</p>

Task Notifications Used in Peripheral Device Drivers: UART Example

Peripheral driver libraries provide functions that perform common operations on hardware interfaces. Examples of peripherals for which such libraries are often provided include Universal Asynchronous Receivers and Transmitters (UARTs), Serial Peripheral Interface (SPI) ports, analog to digital converters (ADCs), and Ethernet ports. Examples of functions typically provided by such libraries include functions to initialize a peripheral, send data to a peripheral, and receive data from a peripheral.

Some operations on peripherals take a relatively long time to complete. Examples of such operations include a high precision ADC conversion, and the transmission of a large data packet on a UART. In these cases the driver library function could be implemented to poll (repeatedly read) the peripheral's status registers to determine when the operation has completed. However, polling in this manner is nearly always wasteful as it utilizes 100% of the processor's time while no productive processing is being performed. The waste is particularly expensive in a multi-tasking system, where a task that is polling a peripheral might be preventing the execution of a lower priority task that does have productive processing to perform.

To avoid the potential for wasted processing time, an efficient RTOS aware device driver should be interrupt driven, and give a task that initiates a lengthy operation the option of waiting in the Blocked state for the operation to complete. That way, lower priority tasks can execute while the task performing the lengthy operation is in the Blocked state, and no tasks use processing time unless they can use it productively.

It is common practice for RTOS aware driver libraries to use a binary semaphore to place tasks into the Blocked state. The technique is demonstrated by the pseudo code shown in Listing 154, which provides the outline of an RTOS aware library function that transmits data on a UART port. In Listing 154:

- xUART is a structure that describes the UART peripheral, and holds state information. The xTxSemaphore member of the structure is a variable of type SemaphoreHandle_t. It is assumed the semaphore has already been created.
- The xUART_Send() function does not include any mutual exclusion logic. If more than one task is going to use the xUART_Send() function, then the application writer will have to manage mutual exclusion within the application itself. For example, a task may be required to obtain a mutex before calling xUART_Send().
- The xSemaphoreTake() API function is used to place the calling task into the Blocked state after the UART transmission has been initiated.
- The xSemaphoreGiveFromISR() API function is used to remove the task from the Blocked state after the transmission has completed, which is when the UART peripheral's transmit end interrupt service routine executes.

```
/* Driver library function to send data to a UART. */
BaseType_t xUART_Send( xUART *pxUARTInstance, uint8_t *pucDataSource, size_t uxLength )
{
    BaseType_t xReturn;

    /* Ensure the UART's transmit semaphore is not already available by attempting to take
    the semaphore without a timeout. */
    xSemaphoreTake( pxUARTInstance->xTxSemaphore, 0 );

    /* Start the transmission. */
    UART_low_level_send( pxUARTInstance, pucDataSource, uxLength );

    /* Block on the semaphore to wait for the transmission to complete. If the semaphore
    is obtained then xReturn will get set to pdPASS. If the semaphore take operation times
    out then xReturn will get set to pdFAIL. Note that, if the interrupt occurs between
    UART_low_level_send() being called, and xSemaphoreTake() being called, then the event
    will be latched in the binary semaphore, and the call to xSemaphoreTake() will return
    immediately. */
    xReturn = xSemaphoreTake( pxUARTInstance->xTxSemaphore, pxUARTInstance->xTxTimeout );

    return xReturn;
}
/*-----*/

/* The service routine for the UART's transmit end interrupt, which executes after the
last byte has been sent to the UART. */
void xUART_TransmitEndISR( xUART *pxUARTInstance )
{
    BaseType_t xHigherPriorityTaskWoken = pdFALSE;

    /* Clear the interrupt. */
    UART_low_level_interrupt_clear( pxUARTInstance );

    /* Give the Tx semaphore to signal the end of the transmission. If a task is Blocked
    waiting for the semaphore then the task will be removed from the Blocked state. */
    xSemaphoreGiveFromISR( pxUARTInstance->xTxSemaphore, &xHigherPriorityTaskWoken );
    portYIELD_FROM_ISR( xHigherPriorityTaskWoken );
}

```

Listing 154. Pseudo code demonstrating how a binary semaphore can be used in a driver library transmit function

The technique demonstrated in Listing 154 is perfectly workable, and indeed common practice, but it has some drawbacks:

- The library uses multiple semaphores, which increases its RAM footprint.
- Semaphores cannot be used until they have been created, so a library that uses semaphores cannot be used until it has been explicitly initialized.
- Semaphores are generic objects that are applicable to a wide range of use cases; they include logic to allow any number of tasks to wait in the Blocked state for the semaphore to become available, and to select (in a deterministic manner) which task to remove from the Blocked state when the semaphore does become available. Executing that logic takes a finite time, and that processing overhead is unnecessary in

the scenario shown is Listing 154, in which there cannot be more than one task waiting for the semaphore at any given time.

Listing 155 demonstrates how to avoid these drawbacks by using a task notification in place of a binary semaphore.

Note: If a library uses task notifications, then the library's documentation must clearly state that calling a library function can change the calling task's notification state and notification value.

In Listing 155:

- The `xTxSemaphore` member of the `xUART` structure has been replaced by the `xTaskToNotify` member. `xTaskToNotify` is a variable of type `TaskHandle_t`, and is used to hold the handle of the task that is waiting for the UART operation to complete.
- The `xTaskGetCurrentTaskHandle()` FreeRTOS API function is used to obtain the handle of the task that is in the Running state.
- The library does not create any FreeRTOS objects, so does not incur a RAM overhead, and does not need to be explicitly initialized.
- The task notification is sent directly to the task that is waiting for the UART operation to complete, so no unnecessary logic is executed.

The `xTaskToNotify` member of the `xUART` structure is accessed from both a task and an interrupt service routine, requiring that consideration be given as to how the processor will update its value:

- If `xTaskToNotify` is updated by a single memory write operation, then it can be updated outside of a critical section, exactly as shown in Listing 155. This would be the case if `xTaskToNotify` is a 32-bit variable (`TaskHandle_t` was a 32-bit type), and the processor on which FreeRTOS is running is a 32-bit processor.
- If more than one memory write operation is required to update `xTaskToNotify`, then `xTaskToNotify` must only be updated from within a critical section—otherwise the interrupt service routine might access `xTaskToNotify` while it is in an inconsistent state. This would be the case if `xTaskToNotify` is a 32-bit variable, and the processor on

which FreeRTOS is running is a 16-bit processor, as it would require two 16-bit memory write operations to update all 32-bits.

Internally, within the FreeRTOS implementation, TaskHandle_t is a pointer, so sizeof(TaskHandle_t) always equals sizeof(void *).

```
/* Driver library function to send data to a UART. */
BaseType_t xUART_Send( xUART *pxUARTInstance, uint8_t *pucDataSource, size_t uxLength )
{
    BaseType_t xReturn;

    /* Save the handle of the task that called this function. The book text contains notes as to
    whether the following line needs to be protected by a critical section or not. */
    pxUARTInstance->xTaskToNotify = xTaskGetCurrentTaskHandle();

    /* Ensure the calling task does not already have a notification pending by calling
    ulTaskNotifyTake() with the xClearCountOnExit parameter set to pdTRUE, and a block time of 0
    (don't block). */
    ulTaskNotifyTake( pdTRUE, 0 );

    /* Start the transmission. */
    UART_low_level_send( pxUARTInstance, pucDataSource, uxLength );

    /* Block until notified that the transmission is complete. If the notification is received
    then xReturn will be set to 1 because the ISR will have incremented this task's notification
    value to 1 (pdTRUE). If the operation times out then xReturn will be 0 (pdFALSE) because
    this task's notification value will not have been changed since it was cleared to 0 above.
    Note that, if the ISR executes between the calls to UART_low_level_send() and the call to
    ulTaskNotifyTake(), then the event will be latched in the task's notification value, and the
    call to ulTaskNotifyTake() will return immediately.*/
    xReturn = ( BaseType_t ) ulTaskNotifyTake( pdTRUE, pxUARTInstance->xTxTimeout );

    return xReturn;
}
/*-----*/

/* The ISR that executes after the last byte has been sent to the UART. */
void xUART_TransmitEndISR( xUART *pxUARTInstance )
{
    BaseType_t xHigherPriorityTaskWoken = pdFALSE;

    /* This function should not execute unless there is a task waiting to be notified. Test this
    condition with an assert. This step is not strictly necessary, but will aid debugging.
    configASSERT() is described in section 11.2.*/
    configASSERT( pxUARTInstance->xTaskToNotify != NULL );

    /* Clear the interrupt. */
    UART_low_level_interrupt_clear( pxUARTInstance );

    /* Send a notification directly to the task that called xUART_Send(). If the task is Blocked
    waiting for the notification then the task will be removed from the Blocked state. */
    vTaskNotifyGiveFromISR( pxUARTInstance->xTaskToNotify, &xHigherPriorityTaskWoken );

    /* Now there are no tasks waiting to be notified. Set the xTaskToNotify member of the xUART
    structure back to NULL. This step is not strictly necessary but will aid debugging. */
    pxUARTInstance->xTaskToNotify = NULL;
    portYIELD_FROM_ISR( xHigherPriorityTaskWoken );
}
```

Listing 155. Pseudo code demonstrating how a task notification can be used in a driver library transmit function

Task notifications can also replace semaphores in receive functions, as demonstrated in pseudo code Listing 156, which provides the outline of an RTOS aware library function that receives data on a UART port. Referring to Listing 156:

- The `xUART_Receive()` function does not include any mutual exclusion logic. If more than one task is going to use the `xUART_Receive()` function, then the application writer will have to manage mutual exclusion within the application itself. For example, a task may be required to obtain a mutex before calling `xUART_Receive()`.
- The UART's receive interrupt service routine places the characters that are received by the UART into a RAM buffer. The `xUART_Receive()` function returns characters from the RAM buffer.
- The `xUART_Receive()` `uxWantedBytes` parameter is used to specify the number of characters to receive. If the RAM buffer does not already contain the requested number characters, then the calling task is placed into the Blocked state to wait to be notified that the number of characters in the buffer has increased. The `while()` loop is used to repeat this sequence until either the receive buffer contains the requested number of characters, or a timeout occurs.
- The calling task may enter the Blocked state more than once. The block time is therefore adjusted to take into account the amount of time that has already passed since `xUART_Receive()` was called. The adjustments ensure the total time spent inside `xUART_Receive()` does not exceed the block time specified by the `xRxTimeout` member of the `xUART` structure. The block time is adjusted using the FreeRTOS `vTaskSetTimeOutState()` and `xTaskCheckForTimeOut()` helper functions.

```
/* Driver library function to receive data from a UART. */
size_t xUART_Receive( xUART *pxUARTInstance, uint8_t *pucBuffer, size_t uxWantedBytes )
{
    size_t uxReceived = 0;
    TickType_t xTicksToWait;
    TimeOut_t xTimeOut;

    /* Record the time at which this function was entered. */
    vTaskSetTimeoutState( &xTimeOut );

    /* xTicksToWait is the timeout value - it is initially set to the maximum receive
    timeout for this UART instance. */
    xTicksToWait = pxUARTInstance->xRxTimeout;

    /* Save the handle of the task that called this function. The book text contains notes
    as to whether the following line needs to be protected by a critical section or not. */
    pxUARTInstance->xTaskToNotify = xTaskGetCurrentTaskHandle();

    /* Loop until the buffer contains the wanted number of bytes, or a timeout occurs. */
    while( UART_bytes_in_rx_buffer( pxUARTInstance ) < uxWantedBytes )
    {
        /* Look for a timeout, adjusting xTicksToWait to account for the time spent in this
        function so far. */
        if( xTaskCheckForTimeout( &xTimeOut, &xTicksToWait ) != pdFALSE )
        {
            /* Timed out before the wanted number of bytes were available, exit the loop. */
            break;
        }

        /* The receive buffer does not yet contain the required amount of bytes. Wait for a
        maximum of xTicksToWait ticks to be notified that the receive interrupt service
        routine has placed more data into the buffer. It does not matter if the calling
        task already had a notification pending when it called this function, if it did, it
        would just iteration around this while loop one extra time. */
        ulTaskNotifyTake( pdTRUE, xTicksToWait );
    }

    /* No tasks are waiting for receive notifications, so set xTaskToNotify back to NULL.
    The book text contains notes as to whether the following line needs to be protected by
    a critical section or not. */
    pxUARTInstance->xTaskToNotify = NULL;

    /* Attempt to read uxWantedBytes from the receive buffer into pucBuffer. The actual
    number of bytes read (which might be less than uxWantedBytes) is returned. */
    uxReceived = UART_read_from_receive_buffer( pxUARTInstance, pucBuffer, uxWantedBytes );

    return uxReceived;
}
/*-----*/

/* The interrupt service routine for the UART's receive interrupt */
void xUART_ReceiveISR( xUART *pxUARTInstance )
{
    BaseType_t xHigherPriorityTaskWoken = pdFALSE;

    /* Copy received data into this UART's receive buffer and clear the interrupt. */
    UART_low_level_receive( pxUARTInstance );

    /* If a task is waiting to be notified of the new data then notify it now. */
    if( pxUARTInstance->xTaskToNotify != NULL )
    {
        vTaskNotifyGiveFromISR( pxUARTInstance->xTaskToNotify, &xHigherPriorityTaskWoken );
        portYIELD_FROM_ISR( xHigherPriorityTaskWoken );
    }
}
```

Listing 156. Pseudo code demonstrating how a task notification can be used in a driver library receive function

Task Notifications Used in Peripheral Device Drivers: ADC Example

The previous section demonstrated how to use `vTaskNotifyGiveFromISR()` to send a task notification from an interrupt to a task. `vTaskNotifyGiveFromISR()` is a simple function to use, but its capabilities are limited; it can only send a task notification as a valueless event, it cannot send data. This section demonstrates how to use `xTaskNotifyFromISR()` to send data with a task notification event. The technique is demonstrated by the pseudo code shown in Listing 157, which provides the outline of an RTOS aware interrupt service routine for an Analog to Digital Converter (ADC). In Listing 157:

- It is assumed an ADC conversion is started at least every 50 milliseconds.
- `ADC_ConversionEndISR()` is the interrupt service routine for the ADC's conversion end interrupt, which is the interrupt that executes each time a new ADC value is available.
- The task implemented by `vADCTask()` processes each value generated by the ADC. It is assumed the task's handle was stored in `xADCTaskToNotify` when the task was created.
- `ADC_ConversionEndISR()` uses `xTaskNotifyFromISR()` with the `eAction` parameter set to `eSetValueWithoutOverwrite` to send a task notification to the `vADCTask()` task, and write the result of the ADC conversion into the task's notification value.
- The `vADCTask()` task uses `xTaskNotifyWait()` to wait to be notified that a new ADC value is available, and to retrieve the result of the ADC conversion from its notification value.

```
/* A task that uses an ADC. */
void vADCTask( void *pvParameters )
{
    uint32_t ulADCValue;
    BaseType_t xResult;

    /* The rate at which ADC conversions are triggered. */
    const TickType_t xADCConversionFrequency = pdMS_TO_TICKS( 50 );

    for( ;; )
    {
        /* Wait for the next ADC conversion result. */
        xResult = xTaskNotifyWait(
            /* The new ADC value will overwrite the old value, so there is no need
            to clear any bits before waiting for the new notification value. */
            0,
            /* Future ADC values will overwrite the existing value, so there is no
            need to clear any bits before exiting xTaskNotifyWait(). */
            0,
            /* The address of the variable into which the task's notification value
            (which holds the latest ADC conversion result) will be copied. */
            &ulADCValue,
            /* A new ADC value should be received every xADCConversionFrequency
            ticks. */
            xADCConversionFrequency * 2 );

        if( xResult == pdPASS )
        {
            /* A new ADC value was received. Process it now. */
            ProcessADCResult( ulADCValue );
        }
        else
        {
            /* The call to xTaskNotifyWait() did not return within the expected time,
            something must be wrong with the input that triggers the ADC conversion, or with
            the ADC itself. Handle the error here. */
        }
    }
}
/*-----*/

/* The interrupt service routine that executes each time an ADC conversion completes. */
void ADC_ConversionEndISR( xADC *pxADCInstance )
{
    uint32_t ulConversionResult;
    BaseType_t xHigherPriorityTaskWoken = pdFALSE, xResult;

    /* Read the new ADC value and clear the interrupt. */
    ulConversionResult = ADC_low_level_read( pxADCInstance );

    /* Send a notification, and the ADC conversion result, directly to vADCTask(). */
    xResult = xTaskNotifyFromISR( xADCTaskToNotify, /* xTaskToNotify parameter. */
        ulConversionResult, /* ulValue parameter. */
        eSetValueWithoutOverwrite, /* eAction parameter. */
        &xHigherPriorityTaskWoken );

    /* If the call to xTaskNotifyFromISR() returns pdFAIL then the task is not keeping up
    with the rate at which ADC values are being generated. configASSERT() is described
    in section 11.2.*/
    configASSERT( xResult == pdPASS );
    portYIELD_FROM_ISR( xHigherPriorityTaskWoken );
}

```

Listing 157. Pseudo code demonstrating how a task notification can be used to pass a value to a task

Task Notifications Used Directly Within an Application

This section reinforces the power of task notifications by demonstrating their use in a hypothetical application that includes the following functionality:

1. The application communicates across a slow internet connection to send data to, and request data from, a remote data server. From here on, the remote data server is referred to as the *cloud server*.
2. After requesting data from the cloud server, the requesting task must wait in the Blocked state for the requested data to be received.
3. After sending data to the cloud server, the sending task must wait in the Blocked state for an acknowledgement that the cloud server received the data correctly.

A schematic of the software design is shown in Figure 81. In Figure 81:

- The complexity of handling multiple internet connections to the cloud server is encapsulated within a single FreeRTOS task. The task acts as a proxy server within the FreeRTOS application, and is referred to as the *server task*.
- Application tasks read data from the cloud server by calling `CloudRead()`. `CloudRead()` does not communicate with the cloud server directly, but instead sends the read request to the server task on a queue, and receives the requested data from the server task as a task notification.
- Application tasks write data to the cloud server by calling `CloudWrite()`. `CloudWrite()` does not communicate with the cloud server directly, but instead sends the write request to the server task on a queue, and receives the result of the write operation from the server task as a task notification.

The structure sent to the server task by the `CloudRead()` and `CloudWrite()` functions is shown in Listing 158.

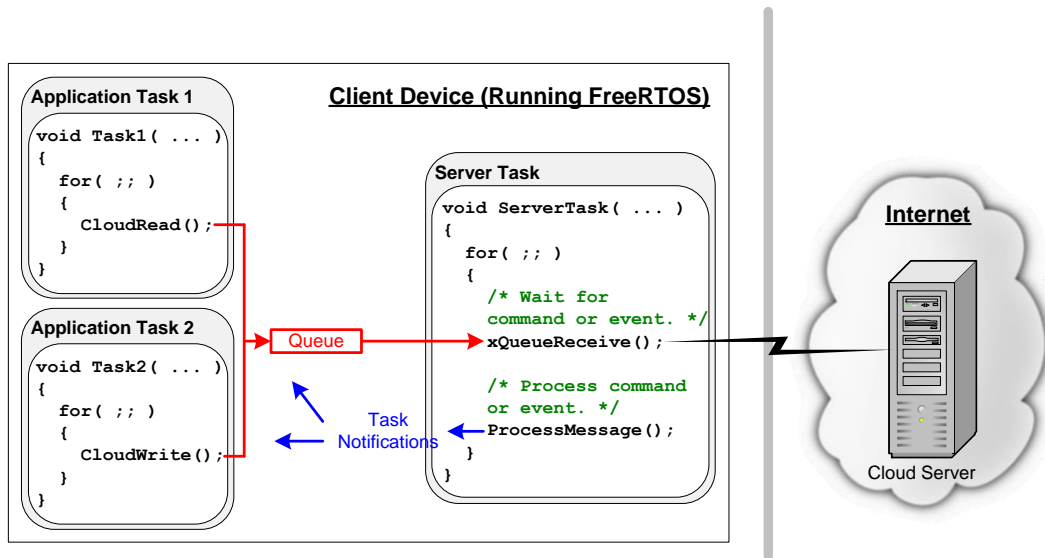

Figure 81 The communication paths from the application tasks to the cloud server, and back again

```

typedef enum CloudOperations
{
    eRead,                /* Send data to the cloud server. */
    eWrite                /* Receive data from the cloud server. */
} Operation_t;

typedef struct CloudCommand
{
    Operation_t eOperation; /* The operation to perform (read or write). */
    uint32_t ulDataID;     /* Identifies the data being read or written. */
    uint32_t ulDataValue; /* Only used when writing data to the cloud server. */
    TaskHandle_t xTaskToNotify; /* The handle of the task performing the operation. */
} CloudCommand_t;

```

Listing 158. The structure and data type sent on a queue to the server task

Pseudo code for CloudRead() is shown in Listing 159. The function sends its request to the server task, then calls xTaskNotifyWait() to wait in the Blocked state until it is notified that the requested data is available.

Pseudo code showing how the server task manages a read request is shown in Listing 160. When the data has been received from the cloud server, the server task unblocks the application task, and sends the received data to the application task, by calling xTaskNotify() with the eAction parameter set to eSetValueWithOverwrite.

Listing 160 shows a simplified scenario, as it assumes GetCloudData() does not have to wait to obtain a value from the cloud server.

```

/* ulDataID identifies the data to read. pulValue holds the address of the variable into
which the data received from the cloud server is to be written. */
BaseType_t CloudRead( uint32_t ulDataID, uint32_t *pulValue )
{
CloudCommand_t xRequest;
BaseType_t xReturn;

/* Set the CloudCommand_t structure members to be correct for this read request. */
xRequest.eOperation = eRead; /* This is a request to read data. */
xRequest.ulDataID = ulDataID; /* A code that identifies the data to read. */
xRequest.xTaskToNotify = xTaskGetCurrentTaskHandle(); /* Handle of the calling task. */

/* Ensure there are no notifications already pending by reading the notification value
with a block time of 0, then send the structure to the server task. */
xTaskNotifyWait( 0, 0, NULL, 0 );
xQueueSend( xServerTaskQueue, &xRequest, portMAX_DELAY );

/* Wait for a notification from the server task. The server task writes the value
received from the cloud server directly into this task's notification value, so there is
no need to clear any bits in the notification value on entry to or exit from the
xTaskNotifyWait() function. The received value is written to *pulValue, so pulValue is
passed as the address to which the notification value is written. */
xReturn = xTaskNotifyWait( 0, /* No bits cleared on entry. */
0, /* No bits to clear on exit. */
pulValue, /* Notification value into *pulValue. */
pdMS_TO_TICKS( 250 ) ); /* Wait a maximum of 250ms. */

/* If xReturn is pdPASS, then the value was obtained. If xReturn is pdFAIL, then the
request timed out. */
return xReturn;
}

```

Listing 159. The Implementation of the Cloud Read API Function

```

void ServerTask( void *pvParameters )
{
CloudCommand_t xCommand;
uint32_t ulReceivedValue;

for( ;; )
{
/* Wait for the next CloudCommand_t structure to be received from a task. */
xQueueReceive( xServerTaskQueue, &xCommand, portMAX_DELAY );

switch( xCommand.eOperation ) /* Was it a read or write request? */
{
case eRead:

/* Obtain the requested data item from the remote cloud server. */
ulReceivedValue = GetCloudData( xCommand.ulDataID );

/* Call xTaskNotify() to send both a notification and the value received from the
cloud server to the task that made the request. The handle of the task is
obtained from the CloudCommand_t structure. */
xTaskNotify( xCommand.xTaskToNotify, /* The task's handle is in the structure. */
ulReceivedValue, /* Cloud data sent as notification value. */
eSetValueWithOverwrite );

break;

/* Other switch cases go here. */

}
}
}

```

Listing 160. The Server Task Processing a Read Request

Pseudo code for CloudWrite() is shown in Listing 161. For the purpose of demonstration, CloudWrite() returns a bitwise status code, where each bit in the status code is assigned a unique meaning. Four example status bits are shown by the #define statements at the top of Listing 161.

The task clears the four status bits, sends its request to the server task, then calls xTaskNotifyWait() to wait in the Blocked state for the status notification.

```
/* Status bits used by the cloud write operation. */
#define SEND_SUCCESSFUL_BIT          ( 0x01 << 0 )
#define OPERATION_TIMED_OUT_BIT     ( 0x01 << 1 )
#define NO_INTERNET_CONNECTION_BIT  ( 0x01 << 2 )
#define CANNOT_LOCATE_CLOUD_SERVER_BIT ( 0x01 << 3 )

/* A mask that has the four status bits set. */
#define CLOUD_WRITE_STATUS_BIT_MASK ( SEND_SUCCESSFUL_BIT |
                                     OPERATION_TIMED_OUT_BIT |
                                     NO_INTERNET_CONNECTION_BIT |
                                     CANNOT_LOCATE_CLOUD_SERVER_BIT )

uint32_t CloudWrite( uint32_t ulDataID, uint32_t ulDataValue )
{
    CloudCommand_t xRequest;
    uint32_t ulNotificationValue;

    /* Set the CloudCommand_t structure members to be correct for this write request. */
    xRequest.eOperation = eWrite;          /* This is a request to write data. */
    xRequest.ulDataID = ulDataID;         /* A code that identifies the data being written. */
    xRequest.ulDataValue = ulDataValue;   /* Value of the data written to the cloud server. */
    xRequest.xTaskToNotify = xTaskGetCurrentTaskHandle(); /* Handle of the calling task. */

    /* Clear the three status bits relevant to the write operation by calling
    xTaskNotifyWait() with the ulBitsToClearOnExit parameter set to
    CLOUD_WRITE_STATUS_BIT_MASK, and a block time of 0. The current notification value is
    not required, so the pulNotificationValue parameter is set to NULL. */
    xTaskNotifyWait( 0, CLOUD_WRITE_STATUS_BIT_MASK, NULL, 0 );

    /* Send the request to the server task. */
    xQueueSend( xServerTaskQueue, &xRequest, portMAX_DELAY );

    /* Wait for a notification from the server task. The server task writes a bitwise status
    code into this task's notification value, which is written to ulNotificationValue. */
    xTaskNotifyWait( 0,
                   CLOUD_WRITE_STATUS_BIT_MASK, /* Clear relevant bits to 0 on exit. */
                   &ulNotificationValue,      /* Notified value. */
                   pdMS_TO_TICKS( 250 ) );    /* Wait a maximum of 250ms. */

    /* Return the status code to the calling task. */
    return ( ulNotificationValue & CLOUD_WRITE_STATUS_BIT_MASK );
}
```

Listing 161. The Implementation of the Cloud Write API Function

Pseudo code demonstrating how the server task manages a write request is shown in Listing 162. When the data has been sent to the cloud server, the server task unblocks the application task, and sends the bitwise status code to the application task, by calling xTaskNotify() with the eAction parameter set to eSetBits. Only the bits defined by the

CLOUD_WRITE_STATUS_BIT_MASK constant can get altered in the receiving task's notification value, so the receiving task can use other bits in its notification value for other purposes.

Listing 162 shows a simplified scenario, as it assumes SetCloudData() does not have to wait to obtain an acknowledgement from the remote cloud server.

```
void ServerTask( void *pvParameters )
{
CloudCommand_t xCommand;
uint32_t ulBitwiseStatusCode;

for( ;; )
{
    /* Wait for the next message. */
    xQueueReceive( xServerTaskQueue, &xCommand, portMAX_DELAY );

    /* Was it a read or write request? */
    switch( xCommand.eOperation )
    {
        case eWrite:

            /* Send the data to the remote cloud server. SetCloudData() returns a bitwise
            status code that only uses the bits defined by the CLOUD_WRITE_STATUS_BIT_MASK
            definition (shown in Listing 161). */
            ulBitwiseStatusCode = SetCloudData( xCommand.ulDataID, xCommand.ulDataValue );

            /* Send a notification to the task that made the write request. The eSetBits
            action is used so any status bits set in ulBitwiseStatusCode will be set in the
            notification value of the task being notified. All the other bits remain
            unchanged. The handle of the task is obtained from the CloudCommand_t
            structure. */
            xTaskNotify( xCommand.xTaskToNotify, /* The task's handle is in the structure. */
                ulBitwiseStatusCode, /* Cloud data sent as notification value. */
                eSetBits );

            break;

        /* Other switch cases go here. */

    }
}
}
```

Listing 162. The Server Task Processing a Send Request

Chapter 10

Low Power Support

TBD. This chapter will be written prior to final publication.

Chapter 11

Developer Support

11.1 Chapter Introduction and Scope

This chapter highlights a set of features that are included to maximize productivity by:

- Providing insight into how an application is behaving.
- Highlighting opportunities for optimization.
- Trapping errors at the point at which they occur.

11.2 configASSERT()

In C, the macro `assert()` is used to verify an *assertion* (an assumption) made by the program. The assertion is written as a C expression, and if the expression evaluates to false (0), then the assertion has deemed to have failed. For example, Listing 163 tests the assertion that the pointer `pxMyPointer` is not NULL.

```
/* Test the assertion that pxMyPointer is not NULL */
assert( pxMyPointer != NULL );
```

Listing 163 Using the standard C `assert()` macro to check `pxMyPointer` is not NULL

The application writer specifies the action to take if an assertion fails by providing an implementation of the `assert()` macro.

The FreeRTOS source code does not call `assert()`, because `assert()` is not available with all the compilers with which FreeRTOS is compiled. Instead, the FreeRTOS source code contains lots of calls to a macro called `configASSERT()`, which can be defined by the application writer in `FreeRTOSConfig.h`, and behaves exactly like the standard C `assert()`.

A failed assertion must be treated as a fatal error. Do not attempt to execute past a line that has failed an assertion.

Using `configASSERT()` improves productivity by immediately trapping and identifying many of the most common sources of error. It is strongly advised to have `configASSERT()` defined while developing or debugging a FreeRTOS application.

Defining `configASSERT()` will greatly assist in run-time debugging, but will also increase the application code size, and therefore slow down its execution. If a definition of `configASSERT()` is not provided, then the default empty definition will be used, and all the calls to `configASSERT()` will be completely removed by the C pre-processor.

Example `configASSERT()` definitions

The definition of `configASSERT()` shown in Listing 164 is useful when an application is being executed under the control of a debugger. It will halt execution on any line that fails an assertion, so the line that failed the assertion will be the line displayed by the debugger when the debug session is paused.

```
/* Disable interrupts so the tick interrupt stops executing, then sit in a loop so
execution does not move past the line that failed the assertion. If the hardware
supports a debug break instruction, then the debug break instruction can be used in
place of the for() loop. */
#define configASSERT( x ) if( ( x ) == 0 ) { taskDISABLE_INTERRUPTS(); for(;;); }
```

Listing 164 A simple configASSERT() definition useful when executing under the control of a debugger

The definition of configASSERT() shown in Listing 165 is useful when an application is not being executed under the control of a debugger. It prints out, or otherwise records, the source code line that failed an assertion. The line that failed the assertion is identified using the standard C `__FILE__` macro to obtain the name of the source file, and the standard C `__LINE__` macro to obtain the line number within the source file.

```
/* This function must be defined in a C source file, not the FreeRTOSConfig.h header
file. */
void vAssertCalled( const char *pcFile, uint32_t ulLine )
{
    /* Inside this function, pcFile holds the name of the source file that contains
the line that detected the error, and ulLine holds the line number in the source
file. The pcFile and ulLine values can be printed out, or otherwise recorded,
before the following infinite loop is entered. */
    RecordErrorInformationHere( pcFile, ulLine );

    /* Disable interrupts so the tick interrupt stops executing, then sit in a loop
so execution does not move past the line that failed the assertion. */
    taskDISABLE_INTERRUPTS();
    for( ;; );
}
/*-----*/

/* These following two lines must be placed in FreeRTOSConfig.h. */
extern void vAssertCalled( const char *pcFile, uint32_t ulLine );
#define configASSERT( x ) if( ( x ) == 0 ) vAssertCalled( __FILE__, __LINE__ )
```

Listing 165 A configASSERT() definition that records the source code line that failed an assertion

11.3 FreeRTOS+Trace

FreeRTOS+Trace is a run-time diagnostic and optimization tool provided by our partner company, Percepio.

FreeRTOS+Trace captures valuable dynamic behavior information, then presents the captured information in interconnected graphical views. The tool is also capable of displaying multiple synchronized views.

The captured information is invaluable when analyzing, troubleshooting, or simply optimizing a FreeRTOS application.

FreeRTOS+Trace can be used side-by-side with a traditional debugger, and complements the debugger's view with a higher level time based perspective.

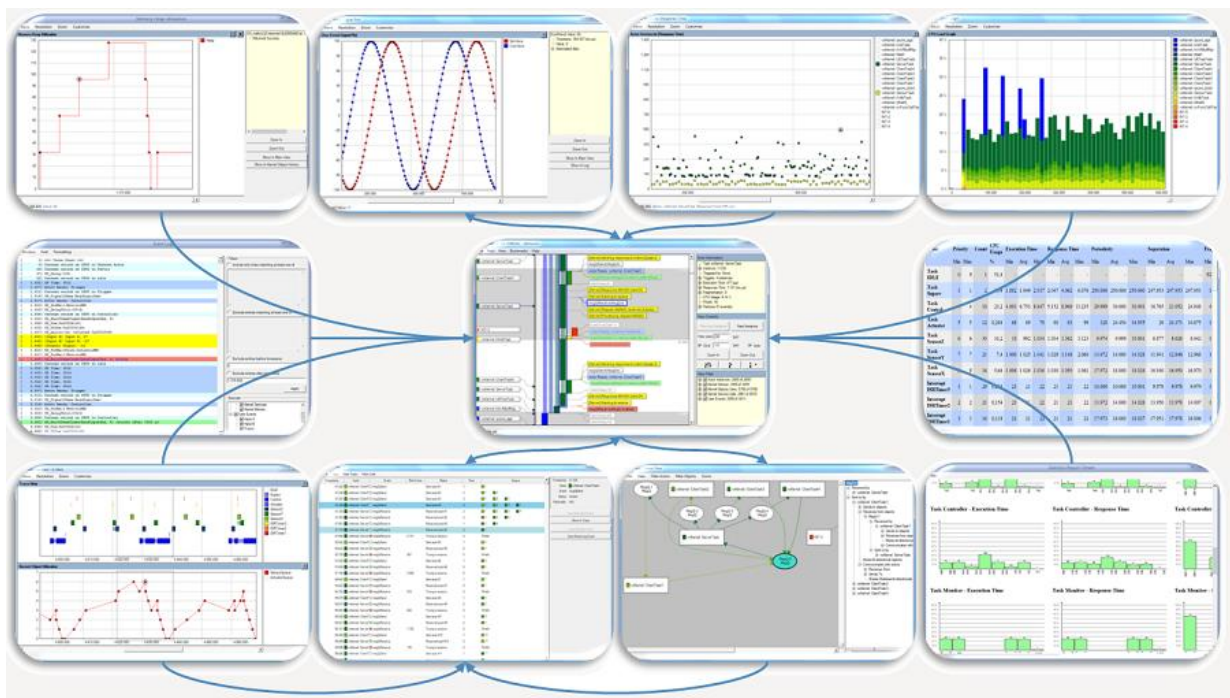

Figure 82 FreeRTOS+Trace includes more than 20 interconnected views

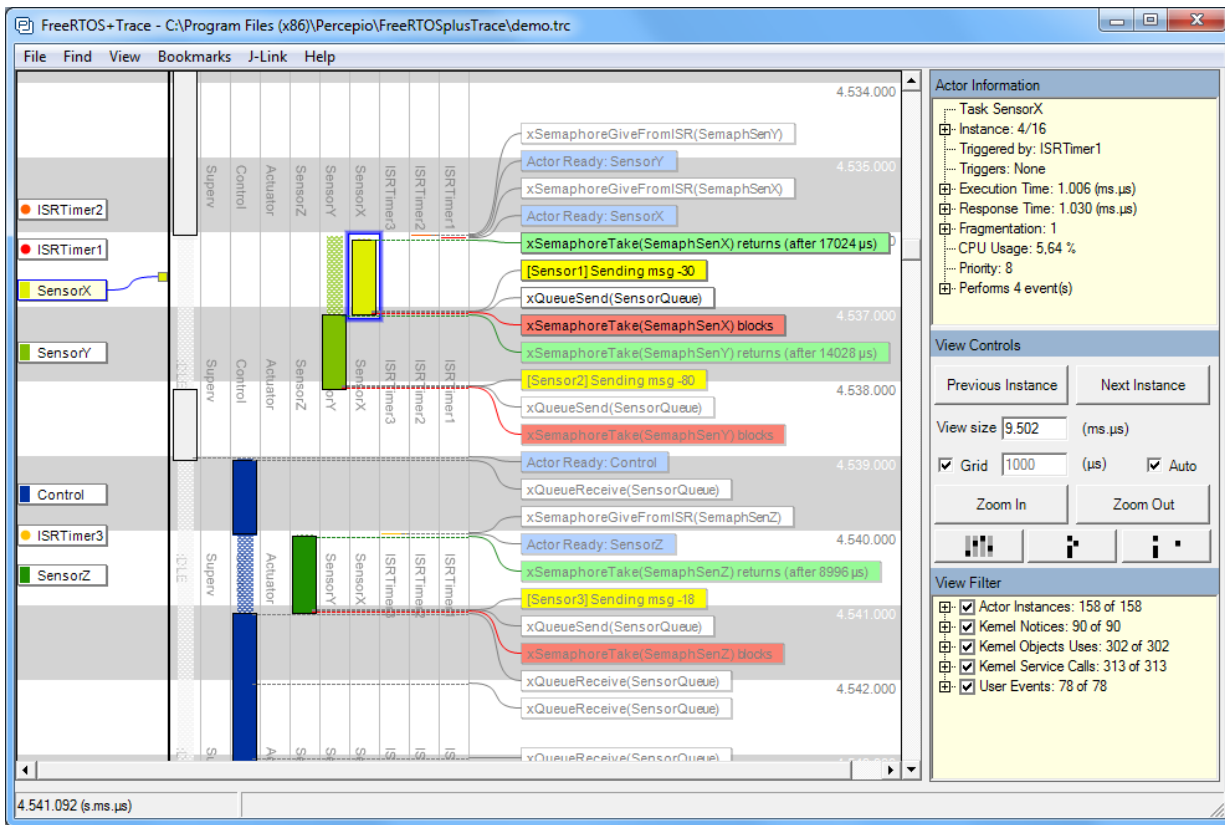

Figure 83 FreeRTOS+Trace main trace view - one of more than 20 interconnected trace views

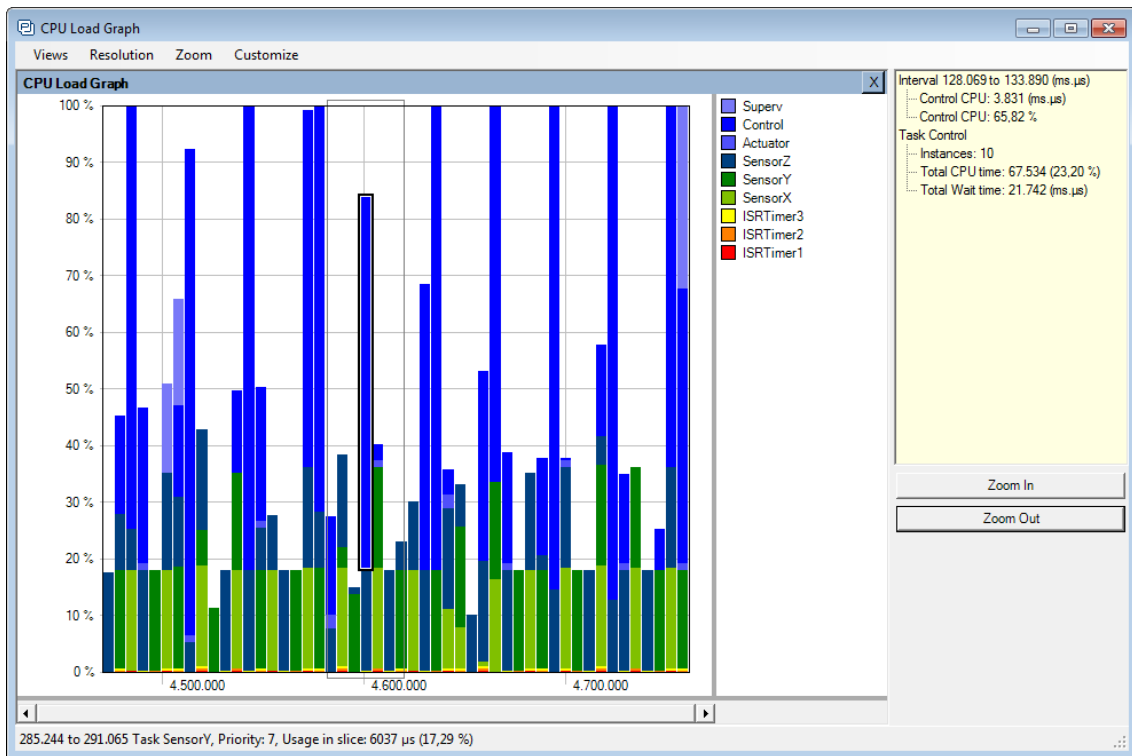

Figure 84 FreeRTOS+Trace CPU load view - one of more than 20 interconnected trace views

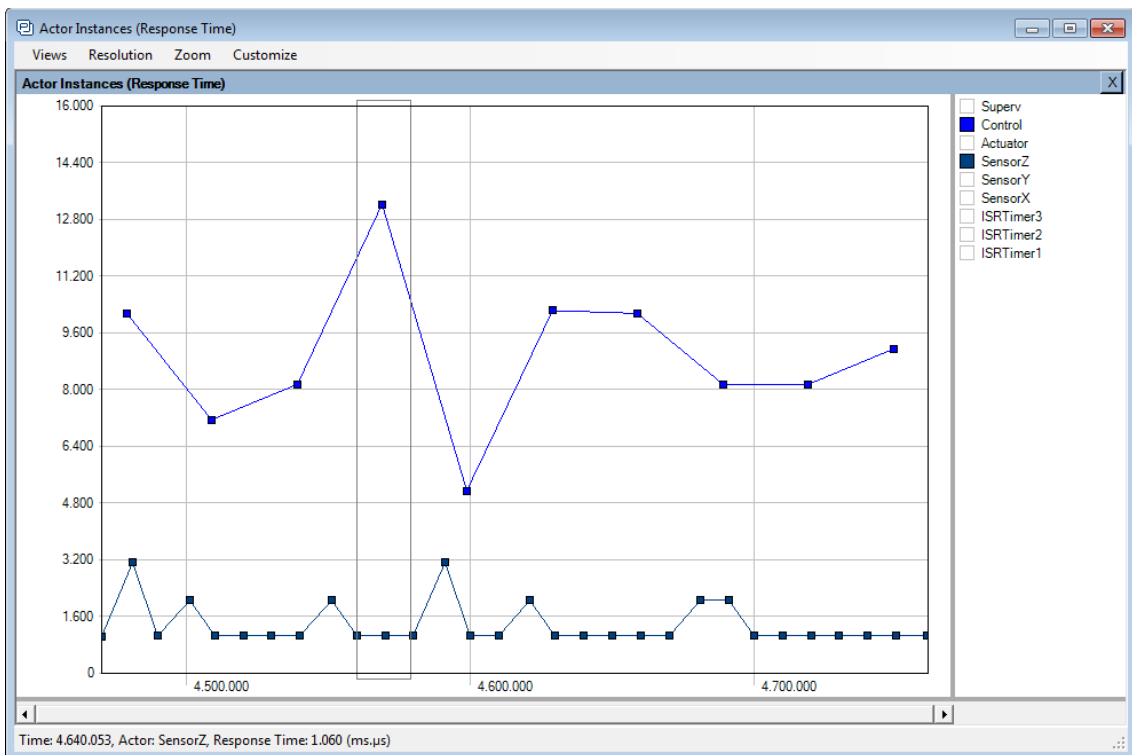

Figure 85 FreeRTOS+Trace response time view - one of more than 20 interconnected trace views

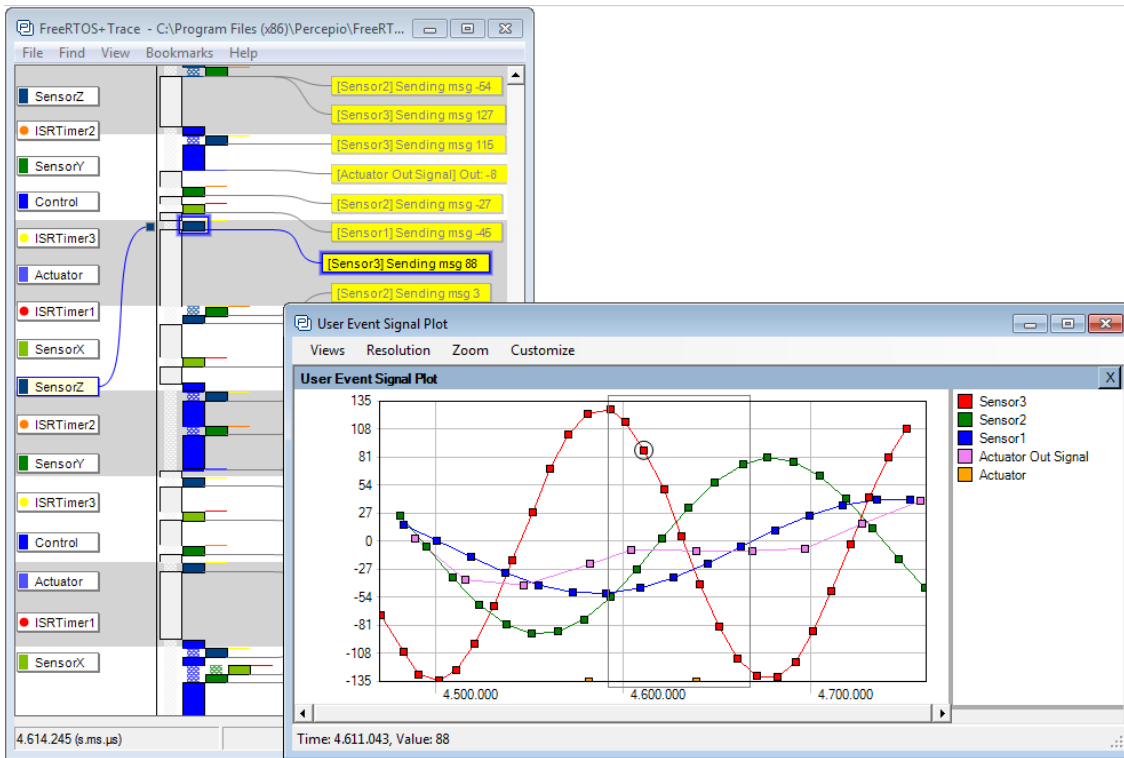

Figure 86 FreeRTOS+Trace user event plot view - one of more than 20 interconnected trace views

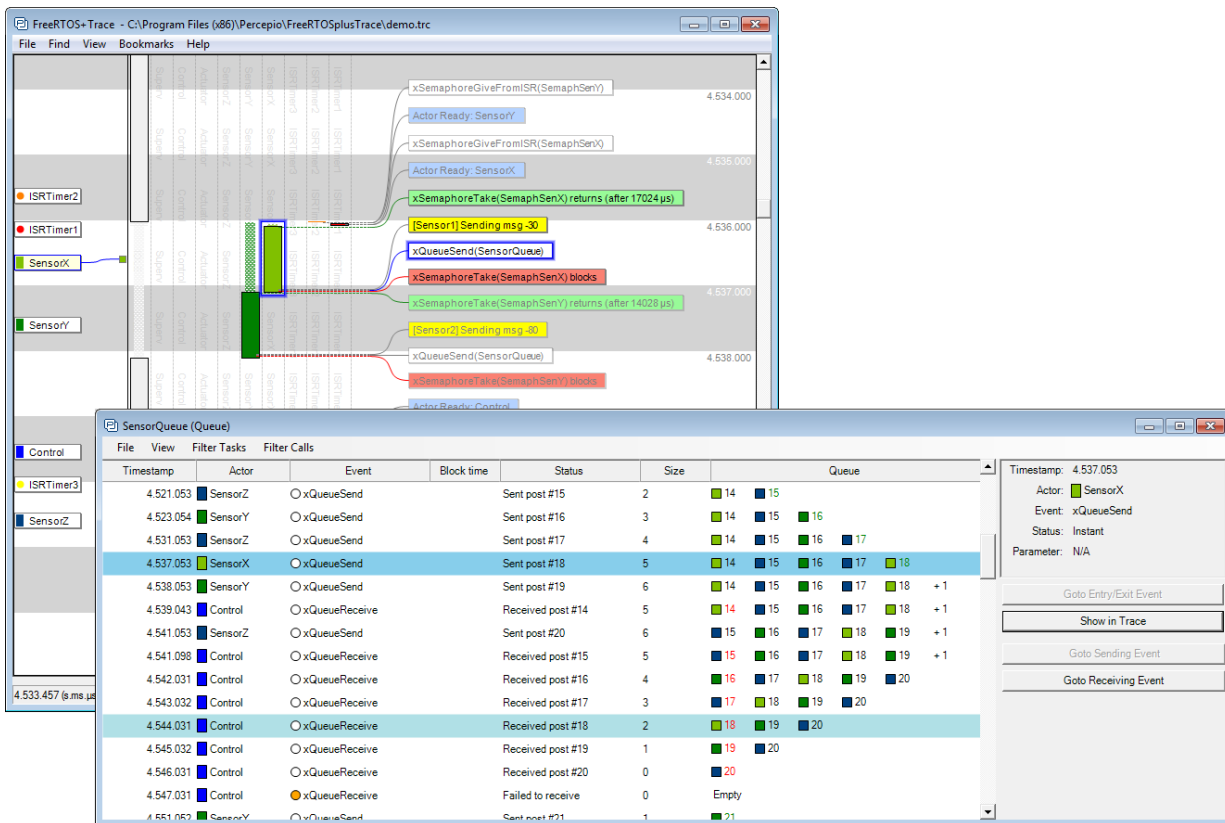

Figure 87 FreeRTOS+Trace kernel object history view - one of more than 20 interconnected trace views

11.4 Debug Related Hook (Callback) Functions

Malloc failed hook

The malloc failed hook (or callback) was described in Chapter 2, Heap Memory Management.

Defining a malloc failed hook ensures the application developer is notified immediately if an attempt to create a task, queue, semaphore or event group fails.

Stack overflow hook

Details of the stack overflow hook are provided in section 12.3, Stack Overflow.

Defining a stack overflow hook ensures the application developer is notified if the amount of stack used by a task exceeds the stack space allocated to the task.

11.5 Viewing Run-time and Task State Information

Task Run-Time Statistics

Task run-time statistics provide information on the amount of processing time each task has received. A task's *run time* is the total time the task has been in the Running state since the application booted.

Run-time statistics are intended to be used as a profiling and debugging aid during the development phase of a project. The information they provide is only valid until the counter used as the run-time statistics clock overflows. Collecting run-time statistics will increase the task context switch time.

To obtain binary run-time statistics information, call the `uxTaskGetSystemState()` API function. To obtain run-time statistics information as a human readable ASCII table, call the `vTaskGetRunTimeStats()` helper function.

The Run-Time Statistics Clock

Run-time statistics need to measure fractions of a tick period. Therefore, the RTOS tick count is not used as the run-time statistics clock, and the clock is instead provided by the application code. It is recommended to make the frequency of the run-time statistics clock between 10 and 100 times faster than the frequency of the tick interrupt. The faster the run-time statistics clock, the more accurate the statistics will be, but also the sooner the time value will overflow.

Ideally, the time value will be generated by a free-running 32-bit peripheral timer/counter, the value of which can be read with no other processing overhead. If the available peripherals and clock speeds do not make that technique possible, then alternative but less efficient techniques include:

1. Configuring a peripheral to generate a periodic interrupt at the desired run-time statistics clock frequency, and then using a count of the number of interrupts generated as the run-time statistics clock.

This method is very inefficient if the periodic interrupt is only used for the purpose of providing a run-time statistics clock. However, if the application already uses a periodic interrupt with a suitable frequency, then it is simple and efficient to add a count of the number of interrupts generated into the existing interrupt service routine.

2. Generate a 32-bit value by using the current value of a free running 16-bit peripheral timer as the 32-bit value's least significant 16-bits, and the number of times the timer has overflowed as the 32-bit value's most significant 16-bits.

It is possible, with appropriate and somewhat complex manipulation, to generate a run-time statistics clock by combining the RTOS tick count with the current value of an ARM Cortex-M SysTick timer. Some of the demo projects in the FreeRTOS download demonstrate how this is achieved.

Configuring an Application to Collect Run-Time Statistics

Table 54 details the macros necessary to collect task run-time statistics. It was originally intended for the macros to be included in the RTOS port layer, which is why the macros are prefixed 'port', but it has proven more practical to define them in FreeRTOSConfig.h.

Table 54. Macros used in the collection of run-time statistics

Macro	Description
configGENERATE_RUN_TIME_STATS	This macro must be set to 1 in FreeRTOSConfig.h. When this macro is set to 1 the scheduler will call the other macros detailed in this table at the appropriate times.
portCONFIGURE_TIMER_FOR_RUN_TIME_STATS()	This macro must be provided to initialize whichever peripheral is used to provide the run-time statistics clock.

Table 54. Macros used in the collection of run-time statistics

Macro	Description
<code>portGET_RUN_TIME_COUNTER_VALUE()</code> , or <code>portALT_GET_RUN_TIME_COUNTER_VALUE(Time)</code>	<p>One of these two macros must be provided to return the current run-time statistics clock value. This is the total time the application has been running, in run-time statistics clock units, since the application first booted.</p> <p>If the first macro is used it must be defined to evaluate to the current clock value. If the second macro is used it must be defined to set its 'Time' parameter to the current clock value.</p>

The `uxTaskGetSystemState()` API Function

`uxTaskGetSystemState()` provides a snapshot of status information for each task under the control of the FreeRTOS scheduler. The information is provided as an array of `TaskStatus_t` structures, with one index in the array for each task. `TaskStatus_t` is described by Listing 167 and Table 56.

```
UBaseType_t uxTaskGetSystemState( TaskStatus_t * const pxTaskStatusArray,  
                                const UBaseType_t uxArraySize,  
                                uint32_t * const pulTotalRunTime );
```

Listing 166. The `uxTaskGetSystemState()` API function prototype

Table 55, uxTaskGetSystemState() parameters and return value

Parameter Name	Description
pxTaskStatusArray	<p>A pointer to an array of TaskStatus_t structures.</p> <p>The array must contain at least one TaskStatus_t structure for each task. The number of tasks can be determined using the uxTaskGetNumberOfTasks() API function.</p> <p>The TaskStatus_t structure is shown in Listing 167, and the TaskStatus_t structure members are described in Table 56.</p>
uxArraySize	<p>The size of the array pointed to by the pxTaskStatusArray parameter. The size is specified as the number of indexes in the array (the number of TaskStatus_t structures contained in the array), not by the number of bytes in the array.</p>
pulTotalRunTime	<p>If configGENERATE_RUN_TIME_STATS is set to 1 in FreeRTOSConfig.h, then *pulTotalRunTime is set by uxTaskGetSystemState() to the total run time (as defined by the run-time statistics clock provided by the application) since the target booted.</p> <p>pulTotalRunTime is optional, and can be set to NULL if the total run time is not required.</p>
Returned value	<p>The number of TaskStatus_t structures that were populated by uxTaskGetSystemState() is returned.</p> <p>The returned value should equal the number returned by the uxTaskGetNumberOfTasks() API function, but will be zero if the value passed in the uxArraySize parameter was too small.</p>

```
typedef struct xTASK_STATUS
{
    TaskHandle_t xHandle;
    const char *pcTaskName;
    UBaseType_t xTaskNumber;
    eTaskState eCurrentState;
    UBaseType_t uxCurrentPriority;
    UBaseType_t uxBasePriority;
    uint32_t ulRunTimeCounter;
    uint16_t usStackHighWaterMark;
} TaskStatus_t;
```

Listing 167. The TaskStatus_t structure

Table 56. TaskStatus_t structure members

Parameter Name/ Returned Value	Description
xHandle	The handle of the task to which the information in the structure relates.
pcTaskName	The human readable text name of the task.
xTaskNumber	Each task has a unique xTaskNumber value. If an application creates and deletes tasks at run time then it is possible that a task will have the same handle as a task that was previously deleted. xTaskNumber is provided to allow application code, and kernel aware debuggers, to distinguish between a task that is still valid, and a deleted task that had the same handle as the valid task.
eCurrentState	An enumerated type that holds the state of the task. eCurrentState can be one of the following values: eRunning, eReady, eBlocked, eSuspended, eDeleted. A task will only be reported as being in the eDeleted state for the short period between the time the task was deleted by a call to vTaskDelete(), and the time the Idle task frees the memory that was allocated to the deleted task's internal data structures and stack. After that time, the task will no longer exist in any way, and it is invalid to attempt to use its handle.

Table 56. TaskStatus_t structure members

Parameter Name/ Returned Value	Description
uxCurrentPriority	The priority at which the task was running at the time uxTaskGetSystemState() was called. uxCurrentPriority will only be higher than the priority assigned to the task by the application writer if the task has temporarily been assigned a higher priority in accordance with the priority inheritance mechanism described in section 7.3, Mutexes (and Binary Semaphores).
uxBasePriority	The priority assigned to the task by the application writer. uxBasePriority is only valid if configUSE_MUTEXES is set to 1 in FreeRTOSConfig.h.
ulRunTimeCounter	The total run time used by the task since the task was created. The total run time is provided as an absolute time that uses the clock provided by the application writer for the collection of run-time statistics. ulRunTimeCounter is only valid if configGENERATE_RUN_TIME_STATS is set to 1 in FreeRTOSConfig.h.
usStackHighWaterMark	The task's stack high water mark. This is the minimum amount of stack space that has remained for the task since the task was created. It is an indication of how close the task has come to overflowing its stack; the closer this value is to zero, the closer the task has come to overflowing its stack. usStackHighWaterMark is specified in bytes.

The vTaskList() Helper Function

vTaskList() provides similar task status information to that provided by uxTaskGetSystemState(), but it presents the information as a human readable ASCII table, rather than an array of binary values.

vTaskList() is a very processor intensive function, and leaves the scheduler suspended for an extended period. Therefore, it is recommended the function is used for debug purposes only, and not in a production real-time system.

vTaskList() is available if configUSE_TRACE_FACILITY and configUSE_STATS_FORMATTING_FUNCTIONS are both set to 1 in FreeRTOSConfig.h.

```
void vTaskList( signed char *pcWriteBuffer );
```

Listing 168. The vTaskList() API function prototype

Table 57. vTaskList() parameters

Parameter Name	Description
pcWriteBuffer	A pointer to a character buffer into which the formatted and human readable table is written. The buffer must be large enough to hold the entire table, as no boundary checking is performed.

An example of the output generated by vTaskList() is shown in Figure 88. In the output:

- Each row provides information on a single task.
- The first column is the task's name.
- The second column is the task's state, where 'R' means Ready, 'B' means Blocked, 'S' means Suspended, and 'D' means the task has been deleted. A task will only be reported as being in the deleted state for the short period between the time the task was deleted by a call to vTaskDelete(), and the time the Idle task frees the memory that was allocated to the deleted task's internal data structures and stack. After that time, the task will no longer exist in any way, and it is invalid to attempt to use its handle.
- The third column is the task's priority.
- The fourth column is the task's stack high water mark. See the description of usStackHighWaterMark in Table 56.
- The fifth column is the unique number allocated to the task. See the description of xTaskNumber in Table 56

tcpip	R	3	393	0
Tmr_Svc	R	3	111	48
QConsB1	R	1	143	3
QProdB5	R	0	144	7
QConsB6	R	0	143	8
PolSEM1	R	0	145	11
PolSEM2	R	0	145	12
GenQ	R	0	155	17
MuLow	R	0	147	18
Rec3	R	0	141	30
SUSP_RX	R	0	148	36
Math1	R	0	167	38
Math2	R	0	167	39

Figure 88 Example output generated by vTaskList()

The vTaskGetRunTimeStats() Helper Function

vTaskGetRunTimeStats() formats collected run-time statistics into a human readable ASCII table.

vTaskGetRunTimeStats() is a very processor intensive function and leaves the scheduler suspended for an extended period. Therefore, it is recommended the function is used for debug purposes only, and not in a production real-time system.

vTaskGetRunTimeStats() is available when configGENERATE_RUN_TIME_STATS and configUSE_STATS_FORMATTING_FUNCTIONS are both set to 1 in FreeRTOSConfig.h.

```
void vTaskGetRunTimeStats( signed char *pcWriteBuffer );
```

Listing 169. The vTaskGetRunTimeStats() API function prototype

Table 58. vTaskGetRunTimeStats() parameters

Parameter Name	Description
pcWriteBuffer	A pointer to a character buffer into which the formatted and human readable table is written. The buffer must be large enough to hold the entire table, as no boundary checking is performed.

An example of the output generated by vTaskGetRunTimeStats() is shown in Figure 89. In the output:

- Each row provides information on a single task.

- The first column is the task name.
- The second column is the amount of time the task has spent in the Running state as an absolute value. See the description of ulRunTimeCounter in Table 56.
- The third column is the amount of time the task has spent in the Running state as a percentage of the total time since the target was booted. The total of the displayed percentage times will normally be less than the expected 100% because statistics are collected and calculated using integer calculations that round down to the nearest integer value.

PolSEM1	994	<1%
PolSEM2	23248	1%
GenQ	194479	16%
MuLow	3690	<1%
Rec3	229450	18%
CNT1	242720	19%
PeekL	94	<1%
CNT_INC	165	<1%
CNT2	243166	20%
SUSP_RX	243192	20%
IDLE	55	<1%

Figure 89 Example output generated by vTaskGetRunTimeStats()

Generating and Displaying Run-Time Statistics, a Worked Example

This example uses a hypothetical 16-bit timer to generate a 32-bit run-time statistics clock. The counter is configured to generate an interrupt each time the 16-bit value reaches its maximum value—effectively creating an overflow interrupt. The interrupt service routine counts the number of overflow occurrences.

The 32-bit value is created by using the count of overflow occurrences as the two most significant bytes of the 32-bit value, and the current 16-bit counter value as the least significant two bytes of the 32-bit value. Pseudo code for the interrupt service routine is shown in Listing 170.

```

void TimerOverflowInterruptHandler( void )
{
    /* Just count the number of interrupts. */
    ulOverflowCount++;

    /* Clear the interrupt. */
    ClearTimerInterrupt();
}

```

Listing 170. 16-bit timer overflow interrupt handler used to count timer overflows

Listing 171 shows the lines added to FreeRTOSConfig.h to enable the collection of run-time statistics.

```

/* Set configGENERATE_RUN_TIME_STATS to 1 to enable collection of run-time
statistics. When this is done, both portCONFIGURE_TIMER_FOR_RUN_TIME_STATS() and
portGET_RUN_TIME_COUNTER_VALUE() or portALT_GET_RUN_TIME_COUNTER_VALUE(x) must also
be defined. */
#define configGENERATE_RUN_TIME_STATS 1

/* portCONFIGURE_TIMER_FOR_RUN_TIME_STATS() is defined to call the function that sets
up the hypothetical 16-bit timer (the function's implementation is not shown). */
void vSetupTimerForRunTimeStats( void );
#define portCONFIGURE_TIMER_FOR_RUN_TIME_STATS() vSetupTimerForRunTimeStats()

/* portALT_GET_RUN_TIME_COUNTER_VALUE() is defined to set its parameter to the
current run-time counter/time value. The returned time value is 32-bits long, and is
formed by shifting the count of 16-bit timer overflows into the top two bytes of a
32-bit number, then bitwise ORing the result with the current 16-bit counter
value. */
#define portALT_GET_RUN_TIME_COUNTER_VALUE( ulCountValue )
{
    extern volatile unsigned long ulOverflowCount;

    /* Disconnect the clock from the counter so it does not change
while its value is being used. */
    PauseTimer();

    /* The number of overflows is shifted into the most significant
two bytes of the returned 32-bit value. */
    ulCountValue = ( ulOverflowCount << 16UL );

    /* The current counter value is used as the least significant
two bytes of the returned 32-bit value. */
    ulCountValue |= ( unsigned long ) ReadTimerCount();

    /* Reconnect the clock to the counter. */
    ResumeTimer();
}

```

Listing 171. Macros added to FreeRTOSConfig.h to enable the collection of run-time statistics

The task shown in Listing 172 prints out the collected run-time statistics every 5 seconds.

```
/* For clarity, calls to fflush() have been omitted from this code listing. */
static void prvStatsTask( void *pvParameters )
{
TickType_t xLastExecutionTime;

/* The buffer used to hold the formatted run-time statistics text needs to be quite
large. It is therefore declared static to ensure it is not allocated on the task
stack. This makes this function non re-entrant. */
static signed char cStringBuffer[ 512 ];

/* The task will run every 5 seconds. */
const TickType_t xBlockPeriod = pdMS_TO_TICKS( 5000 );

/* Initialize xLastExecutionTime to the current time. This is the only time this
variable needs to be written to explicitly. Afterwards it is updated internally
within the vTaskDelayUntil() API function. */
xLastExecutionTime = xTaskGetTickCount();

/* As per most tasks, this task is implemented in an infinite loop. */
for( ;; )
{
/* Wait until it is time to run this task again. */
vTaskDelayUntil( &xLastExecutionTime, xBlockPeriod );

/* Generate a text table from the run-time stats. This must fit into the
cStringBuffer array. */
vTaskGetRunTimeStats( cStringBuffer );

/* Print out column headings for the run-time stats table. */
printf( "\nTask\t\tAbs\t\t\t\t%\n" );
printf( "-----\n" );

/* Print out the run-time stats themselves. The table of data contains
multiple lines, so the vPrintMultipleLines() function is called instead of
calling printf() directly. vPrintMultipleLines() simply calls printf() on
each line individually, to ensure the line buffering works as expected. */
vPrintMultipleLines( cStringBuffer );
}
}
```

Listing 172. The task that prints out the collected run-time statistics

11.6 Trace Hook Macros

Trace macros are macros that have been placed at key points within the FreeRTOS source code. By default, the macros are empty, and so do not generate any code, and have no run time overhead. By overriding the default empty implementations, an application writer can:

- Insert code into FreeRTOS without modifying the FreeRTOS source files.
- Output detailed execution sequencing information by any means available on the target hardware. Trace macros appear in enough places in the FreeRTOS source code to allow them to be used to create a full and detailed scheduler activity trace and profiling log.

Available Trace Hook Macros

It would take too much space to detail every macro here. Table 59 details the subset of macros deemed to be most useful to an application writer.

Many of the descriptions in Table 59 refer to a variable called `pxCurrentTCB`. `pxCurrentTCB` is a FreeRTOS private variable that holds the handle of the task in the Running state, and is available to any macro that is called from the FreeRTOS/Source/tasks.c source file.

Table 59. A selection of the most commonly used trace hook macros

Macro	Description
<code>traceTASK_INCREMENT_TICK(xTickCount)</code>	Called during the tick interrupt, after the tick count is incremented. The <code>xTickCount</code> parameter passes the new tick count value into the macro.
<code>traceTASK_SWITCHED_OUT()</code>	Called before a new task is selected to run. At this point, <code>pxCurrentTCB</code> contains the handle of the task about to leave the Running state.

Table 59. A selection of the most commonly used trace hook macros

Macro	Description
traceTASK_SWITCHED_IN()	Called after a task is selected to run. At this point, pxCurrentTCB contains the handle of the task about to enter the Running state.
traceBLOCKING_ON_QUEUE_RECEIVE(pxQueue)	Called immediately before the currently executing task enters the Blocked state following an attempt to read from an empty queue, or an attempt to 'take' an empty semaphore or mutex. The pxQueue parameter passes the handle of the target queue or semaphore into the macro.
traceBLOCKING_ON_QUEUE_SEND(pxQueue)	Called immediately before the currently executing task enters the Blocked state following an attempt to write to a queue that is full. The pxQueue parameter passes the handle of the target queue into the macro.
traceQUEUE_SEND(pxQueue)	Called from within xQueueSend(), xQueueSendToFront(), xQueueSendToBack(), or any of the semaphore 'give' functions, when the queue send or semaphore 'give' is successful. The pxQueue parameter passes the handle of the target queue or semaphore into the macro.

Table 59. A selection of the most commonly used trace hook macros

Macro	Description
traceQUEUE_SEND_FAILED(pxQueue)	Called from within xQueueSend(), xQueueSendToFront(), xQueueSendToBack(), or any of the semaphore 'give' functions, when the queue send or semaphore 'give' operation fails. A queue send or semaphore 'give' will fail if the queue is full and remains full for the duration of any block time specified. The pxQueue parameter passes the handle of the target queue or semaphore into the macro.
traceQUEUE_RECEIVE(pxQueue)	Called from within xQueueReceive() or any of the semaphore 'take' functions, when the queue receive or semaphore 'take' is successful. The pxQueue parameter passes the handle of the target queue or semaphore into the macro.

Table 59. A selection of the most commonly used trace hook macros

Macro	Description
traceQUEUE_RECEIVE_FAILED(pxQueue)	Called from within xQueueReceive() or any of the semaphore 'take' functions, when the queue or semaphore receive operation fails. A queue receive or semaphore 'take' operation will fail if the queue or semaphore is empty and remains empty for the duration of any block time specified. The pxQueue parameter passes the handle of the target queue or semaphore into the macro.
traceQUEUE_SEND_FROM_ISR(pxQueue)	Called from within xQueueSendFromISR() when the send operation is successful. The pxQueue parameter passes the handle of the target queue into the macro.
traceQUEUE_SEND_FROM_ISR_FAILED(pxQueue)	Called from within xQueueSendFromISR() when the send operation fails. A send operation will fail if the queue is already full. The pxQueue parameter passes the handle of the target queue into the macro.

Table 59. A selection of the most commonly used trace hook macros

Macro	Description
traceQUEUE_RECEIVE_FROM_ISR(pxQueue)	Called from within xQueueReceiveFromISR() when the receive operation is successful. The pxQueue parameter passes the handle of the target queue into the macro.
traceQUEUE_RECEIVE_FROM_ISR_FAILED(pxQueue)	Called from within xQueueReceiveFromISR() when the receive operation fails due to the queue already being empty. The pxQueue parameter passes the handle of the target queue into the macro.
traceTASK_DELAY_UNTIL()	Called from within vTaskDelayUntil() immediately before the calling task enters the Blocked state.
traceTASK_DELAY()	Called from within vTaskDelay() immediately before the calling task enters the Blocked state.

Defining Trace Hook Macros

Each trace macro has a default empty definition. The default definition can be overridden by providing a new macro definition in FreeRTOSConfig.h. If trace macro definitions become long or complex, then they can be implemented in a new header file that is then itself included from FreeRTOSConfig.h.

In accordance with software engineering best practice, FreeRTOS maintains a strict data hiding policy. Trace macros allow user code to be added to the FreeRTOS source files, so the data types visible to the trace macros will be different to those visible to application code:

- Inside the FreeRTOS/Source/tasks.c source file, a task handle is a pointer to the data structure that describes a task (the task's *Task Control Block*, or *TCB*). Outside of the FreeRTOS/Source/tasks.c source file a task handle is a pointer to void.
- Inside the FreeRTOS/Source/queue.c source file, a queue handle is a pointer to the data structure that describes a queue. Outside of the FreeRTOS/Source/queue.c source file a queue handle is a pointer to void.

Extreme caution is required if a normally private FreeRTOS data structure is accessed directly by a trace macro, as private data structures might change between FreeRTOS versions.

FreeRTOS Aware Debugger Plug-ins

Plug-ins that provide some FreeRTOS awareness are available for the following IDEs. This list may not be an exhaustive:

- Eclipse (StateViewer)
- Eclipse (ThreadSpy)
- IAR
- ARM DS-5
- Atollic TrueStudio
- Microchip MPLAB
- iSYSTEM WinIDEA

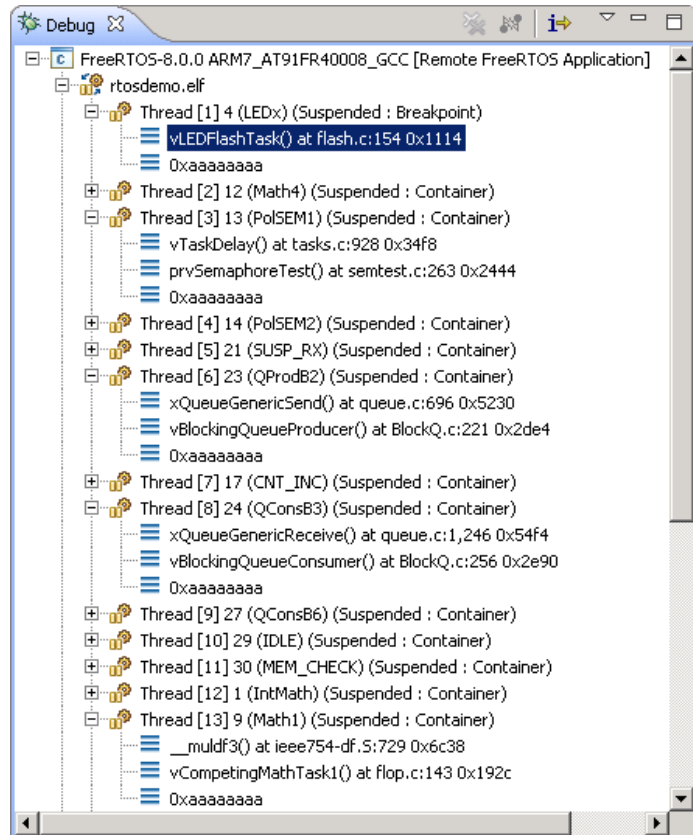

Figure 90 FreeRTOS ThreadSpy Eclipse plug-in from Code Confidence Ltd.

Chapter 12

Trouble Shooting

12.1 Chapter Introduction and Scope

This chapter highlights the most common issues encountered by users who are new to FreeRTOS. First it focuses on three issues that have proven to be the most frequent source of support requests over the years; incorrect interrupt priority assignment, stack overflow, and inappropriate use of `printf()`. It then briefly, and in an FAQ style, touches on other common errors, their possible cause, and their solutions.

Using `configASSERT()` improves productivity by immediately trapping and identifying many of the most common sources of error. It is strongly advised to have `configASSERT()` defined while developing or debugging a FreeRTOS application. `configASSERT()` is described in section 11.2.

12.2 Interrupt Priorities

Note: This is the number one cause of support requests, and in most ports defining configASSERT() will trap the error immediately!

If the FreeRTOS port in use supports interrupt nesting, and the service routine for an interrupt makes use of the FreeRTOS API, then it is *essential* the interrupt's priority is set at or below configMAX_SYSCALL_INTERRUPT_PRIORITY, as described in section 6.8, Interrupt Nesting. Failure to do this will result in ineffective critical sections, which in turn will result in intermittent failures.

Take particular care if running FreeRTOS on a processor where:

- Interrupt priorities default to having the highest possible priority, which is the case on some ARM Cortex processors, and possibly others. On such processors, the priority of an interrupt that uses the FreeRTOS API cannot be left uninitialized.
- Numerically high priority numbers represent logically low interrupt priorities, which may seem counterintuitive, and therefore cause confusion. Again this is the case on ARM Cortex processors, and possibly others.
- For example, on such a processor an interrupt that is executing at priority 5 can itself be interrupted by an interrupt that has a priority of 4. Therefore, if configMAX_SYSCALL_INTERRUPT_PRIORITY is set to 5, any interrupt that uses the FreeRTOS API can only be assigned a priority numerically higher than or equal to 5. In that case, interrupt priorities of 5 or 6 would be valid, but an interrupt priority of 3 is definitely invalid.
- Different library implementations expect the priority of an interrupt to be specified in a different way. Again, particularly relevant to libraries that target ARM Cortex processors, where interrupt priorities are bit shifted before being written to the hardware registers. Some libraries will perform the bit shift themselves, whereas others expect the bit shift to be performed before the priority is passed into the library function.
- Different implementations of the same architecture implement a different number of interrupt priority bits. For example, a Cortex-M processor from one manufacturer may

implement 3 priority bits, while a Cortex-M processor from another manufacturers may implement 4 priority bits.

- The bits that define the priority of an interrupt can be split between bits that define a pre-emption priority, and bits that define a sub-priority. Ensure all the bits are assigned to specifying a pre-emption priority, so sub-priorities are not used.

In some FreeRTOS ports, `configMAX_SYSCALL_INTERRUPT_PRIORITY` has the alternative name `configMAX_API_CALL_INTERRUPT_PRIORITY`.

12.3 Stack Overflow

Stack overflow is the second most common source of support requests. FreeRTOS provides several features to assist trapping and debugging stack related issues¹.

The `uxTaskGetStackHighWaterMark()` API Function

Each task maintains its own stack, the total size of which is specified when the task is created. `uxTaskGetStackHighWaterMark()` is used to query how close a task has come to overflowing the stack space allocated to it. This value is called the stack ‘high water mark’.

```
UBaseType_t uxTaskGetStackHighWaterMark( TaskHandle_t xTask );
```

Listing 173. The `uxTaskGetStackHighWaterMark()` API function prototype

Table 60. `uxTaskGetStackHighWaterMark()` parameters and return value

Parameter Name/ Returned Value	Description
<code>xTask</code>	<p>The handle of the task whose stack high water mark is being queried (the subject task)—see the <code>pxCreatedTask</code> parameter of the <code>xTaskCreate()</code> API function for information on obtaining handles to tasks.</p> <p>A task can query its own stack high water mark by passing <code>NULL</code> in place of a valid task handle.</p>
Returned value	<p>The amount of stack used by the task grows and shrinks as the task executes and interrupts are processed.</p> <p><code>uxTaskGetStackHighWaterMark()</code> returns the minimum amount of remaining stack space that has been available since the task started executing. This is the amount of stack that remains unused when stack usage is at its greatest (or deepest) value. The closer the high water mark is to zero, the closer the task has come to overflowing its stack.</p>

¹ These features are not available in the FreeRTOS Windows port.

Run Time Stack Checking—Overview

FreeRTOS includes two optional run time stack checking mechanisms. These are controlled by the `configCHECK_FOR_STACK_OVERFLOW` compile time configuration constant within `FreeRTOSConfig.h`. Both methods increase the time it takes to perform a context switch.

The stack overflow hook (or stack overflow callback) is a function that is called by the kernel when it detects a stack overflow. To use a stack overflow hook function:

1. Set `configCHECK_FOR_STACK_OVERFLOW` to either 1 or 2 in `FreeRTOSConfig.h`, as described in the following sub-sections.
2. Provide the implementation of the hook function, using the exact function name and prototype shown in Listing 174.

```
void vApplicationStackOverflowHook( TaskHandle_t *pxTask, signed char *pcTaskName );
```

Listing 174. The stack overflow hook function prototype

The stack overflow hook is provided to make trapping and debugging stack errors easier, but there is no real way to recover from a stack overflow when it occurs. The function's parameters pass the handle and name of the task that has overflowed its stack into the hook function.

The stack overflow hook gets called from the context of an interrupt.

Some microcontrollers generate a fault exception when they detect an incorrect memory access, and it is possible for a fault to be triggered before the kernel has a chance to call the stack overflow hook function.

Run Time Stack Checking—Method 1

Method 1 is selected when `configCHECK_FOR_STACK_OVERFLOW` is set to 1.

A task's entire execution context is saved onto its stack each time it gets swapped out. It is likely that this will be the time at which stack usage reaches its peak. When `configCHECK_FOR_STACK_OVERFLOW` is set to 1, the kernel checks that the stack pointer remains within the valid stack space after the context has been saved. The stack overflow hook is called if the stack pointer is found to be outside its valid range.

Method 1 is quick to execute, but can miss stack overflows that occur between context switches.

Run Time Stack Checking—Method 2

Method 2 performs additional checks to those already described for method 1. It is selected when `configCHECK_FOR_STACK_OVERFLOW` is set to 2.

When a task is created, its stack is filled with a known pattern. Method 2 tests the last valid 20 bytes of the task stack space to verify that this pattern has not been overwritten. The stack overflow hook function is called if any of the 20 bytes have changed from their expected values.

Method 2 is not as quick to execute as method 1, but is still relatively fast, as only 20 bytes are tested. Most likely, it will catch all stack overflows; however, it is possible (but highly improbable) that some overflows will be missed.

12.4 Inappropriate Use of printf() and sprintf()

Inappropriate use of printf() is a common source of error, and, unaware of this, it is common for application developers to then add further calls to printf() to aid debugging, and in-so-doing, exasperate the problem.

Many cross compiler vendors will provide a printf() implementation that is suitable for use in small embedded systems. Even when that is the case, the implementation may not be thread safe, probably won't be suitable for use inside an interrupt service routine, and depending on where the output is directed, take a relatively long time to execute.

Particular care must be taken if a printf() implementation that is specifically designed for small embedded systems is not available, and a generic printf() implementation is used instead, as:

- Just including a call to printf() or sprintf() can massively increase the size of the application's executable.
- printf() and sprintf() may call malloc(), which might be invalid if a memory allocation scheme other than heap_3 is in use. See section 2.2, Example Memory Allocation Schemes, for more information.
- printf() and sprintf() may require a stack that is many times bigger than would otherwise be required.

Printf-stdarg.c

Many of the FreeRTOS demonstration projects use a file called printf-stdarg.c, which provides a minimal and stack-efficient implementation of sprintf() that can be used in place of the standard library version. In most cases, this will permit a much smaller stack to be allocated to each task that calls sprintf() and related functions.

printf-stdarg.c also provides a mechanism for directing the printf() output to a port character by character, which while slow, allows stack usage to be decreased even further.

Note that not all copies of printf-stdarg.c included in the FreeRTOS download implement snprintf(). Copies that do not implement snprintf() simply ignore the buffer size parameter, as they map directly to sprintf().

Printf-stdarg.c is open source, but is owned by a third party, and therefore licensed separately from FreeRTOS. The license terms are contained at the top of the source file.

12.5 Other Common Sources of Error

Symptom: Adding a simple task to a demo causes the demo to crash

Creating a task requires memory to be obtained from the heap. Many of the demo application projects dimension the heap to be exactly big enough to create the demo tasks—so, after the tasks are created, there will be insufficient heap remaining for any further tasks, queues, event groups, or semaphores to be added.

The idle task, and possibly also the RTOS daemon task, are created automatically when `vTaskStartScheduler()` is called. `vTaskStartScheduler()` will return only if there is not enough heap memory remaining for these tasks to be created. Including a null loop [`for(;;);`] after the call to `vTaskStartScheduler()` can make this error easier to debug.

To be able to add more tasks, either increase the heap size, or remove some of the existing demo tasks. See section 2.2, Example Memory Allocation Schemes, for more information.

Symptom: Using an API function within an interrupt causes the application to crash

Do not use API functions within interrupt service routines, unless the name of the API function ends with `'...FromISR()'`. In particular, do not create a critical section within an interrupt unless using the interrupt safe macros. See section 6.2, Using the FreeRTOS API from an ISR, for more information.

In FreeRTOS ports that support interrupt nesting, do not use any API functions in an interrupt that has been assigned an interrupt priority above `configMAX_SYSCALL_INTERRUPT_PRIORITY`. See section 6.8, Interrupt Nesting, for more information.

Symptom: Sometimes the application crashes within an interrupt service routine

The first thing to check is that the interrupt is not causing a stack overflow. Some ports only check for stack overflow within tasks, and not within interrupts.

The way interrupts are defined and used differs between ports and between compilers. Therefore, the second thing to check is that the syntax, macros, and calling conventions used in the interrupt service routine are exactly as described on the documentation page provided

for the port being used, and exactly as demonstrated in the demo application provided with the port.

If the application is running on a processor that uses numerically low priority numbers to represent logically high priorities, then ensure the priority assigned to each interrupt takes that into account, as it can seem counter-intuitive. If the application is running on a processor that defaults the priority of each interrupt to the maximum possible priority, then ensure the priority of each interrupt is not left at its default value. See section 6.8, Interrupt Nesting, and section 12.2, Interrupt Priorities, for more information.

Symptom: The scheduler crashes when attempting to start the first task

Ensure the FreeRTOS interrupt handlers have been installed. Refer to the documentation page for the FreeRTOS port in use for information, and the demo application provided for the port for an example.

Some processors must be in a privileged mode before the scheduler can be started. The easiest way to achieve this is to place the processor into a privileged mode within the C startup code, before main() is called.

Symptom: Interrupts are unexpectedly left disabled, or critical sections do not nest correctly

If a FreeRTOS API function is called before the scheduler has been started then interrupts will deliberately be left disabled, and not re-enable again until the first task starts to execute. This is done to protect the system from crashes caused by interrupts attempting to use FreeRTOS API functions during system initialization, before the scheduler has been started, and while the scheduler may be in an inconsistent state.

Do not alter the microcontroller interrupt enable bits or priority flags using any method other than calls to taskENTER_CRITICAL() and taskEXIT_CRITICAL(). These macros keep a count of their call nesting depth to ensure interrupts become enabled again only when the call nesting has unwound completely to zero. Be aware that some library functions may themselves enable and disable interrupts.

Symptom: The application crashes even before the scheduler is started

An interrupt service routine that could potentially cause a context switch must not be permitted to execute before the scheduler has been started. The same applies to any interrupt service

routine that attempts to send to or receive from a FreeRTOS object, such as a queue or semaphore. A context switch cannot occur until after the scheduler has started.

Many API functions cannot be called until after the scheduler has been started. It is best to restrict API usage to the creation of objects such as tasks, queues, and semaphores, rather than the use of these objects, until after `vTaskStartScheduler()` has been called.

Symptom: Calling API functions while the scheduler is suspended, or from inside a critical section, causes the application to crash

The scheduler is suspended by calling `vTaskSuspendAll()` and resumed (unsuspended) by calling `xTaskResumeAll()`. A critical section is entered by calling `taskENTER_CRITICAL()`, and exited by calling `taskEXIT_CRITICAL()`.

Do not call API functions while the scheduler is suspended, or from inside a critical section.

INDEX

A

atomic, 235

B

background
 background processing, 76
BaseType_t, 22
best fit, 30, 32
Binary Semaphore, 191
Blocked State, 64
Blocking on Queue Reads, 106
Blocking on Queue Writes, 106
Building FreeRTOS, 11

C

configAPPLICATION_ALLOCATED_HEAP, 35
configCHECK_FOR_STACK_OVERFLOW, 360
configGENERATE_RUN_TIME_STATS, 338
configIDLE_SHOULD_YIELD, 75, 95
configKERNEL_INTERRUPT_PRIORITY, 228
configMAX_PRIORITIES, 58
configMAX_SYSCALL_INTERRUPT_PRIORITY, 228
configMINIMAL_STACK_DEPTH, 50
configTICK_RATE_HZ, 60
configTOTAL_HEAP_SIZE, 29
configUSE_IDLE_HOOK, 77
configUSE_PORT_OPTIMISED_TASK_SELECTION,
 58
configUSE_PREEMPTION, 90
configUSE_TASK_NOTIFICATIONS, 295
configUSE_TICKLESS_IDLE, 90
configUSE_TIME_SLICING, 90
continuous processing, 72
 continuous processing task, 64
co-operative scheduling, 97
Counting Semaphores, 208
Creating a FreeRTOS Project, 18
Creating Tasks, 48
critical regions, 238
critical section, 230
Critical sections, 238

D

Data Types, 21
Deadlock, 251
Deadly Embrace, 251
deferred interrupts, 191
Deleting a Task, 85
Demo Applications, 16

E

eNoAction, 309
eNotifyAction, 308

errQUEUE_FULL, 111
eSetBits, 309
eSetValueWithoutOverwrite, 309
eSetValueWithOverwrite, 310
Event Bits, 268
event driven, 64
Event Flags, 268
Event Groups, 265
EventBits_t, 269
EventGroupHandle_t, 271
Events, 182

F

fixed execution period, 70
Fixed Priority, 92
Formatting, 23
free(), 26
FreeRTOSConfig.h, 11
Function Names, 22
Function Reentrancy, 235

G

Gatekeeper tasks, 259

H

Header Files, 15
Heap_1, 29
Heap_2, 30
Heap_3, 32
Heap_4, 32
heap_5, 35
HeapRegion_t, 36
high water mark, 359
highest priority, 51

I

Idle Task, 68, 75
Idle Task Hook, 75
Include Paths, 14
Interrupt Nesting, 228

L

locking the scheduler, 240
low power mode, 76
lowest priority, 51, 58

M

Macro Names, 23
Malloc Failed Hook, 42
malloc(), 26
Measuring the amount of spare processing capacity, 76
Mutex, 243
mutual exclusion, 236

N

non-atomic, 235
Not Running state, 47

O

OpenRTOS, 6

P

pdMS_TO_TICKS, 61
periodic
 periodic tasks, 66
periodic interrupt, 60
Port, 11
portCONFIGURE_TIMER_FOR_RUN_TIME_STATS,
 338
portGET_RUN_TIME_COUNTER_VALUE, 339
portMAX_DELAY, 110, 112, 161, 171, 175, 278, 289,
 301
pre-empted
 pre-emption, 75
Pre-emptive, 92
Priorities, 58
Prioritized Pre-emptive Scheduling, 95
priority, 51, 58
priority inheritance, 250
priority inversion, 249
pvParameters, 50, 159, 215, 341
pvPortMalloc(), 27

Q

queue access by Multiple Tasks, 106
queue block time, 106
queue item size, 103
queue length, 103
QueueHandle_t, 108
Queues, 101
QueueSetHandle_t, 132

R

RAM allocation, 27
Read, Modify, Write Operations, 234
Ready state, 65
reentrant, 235
Round Robin, 91
Run Time Stack Checking, 360
Run Time Statistics, 337
Running state, 47, 64

S

SafeRTOS, 6
Scheduling Algorithms, 90
SemaphoreHandle_t, 194, 210, 245
Software Timers, 147
Source Files, 12
spare processing capacity
 measuring spare processing capacity, 69
Stack Overflow, 359
stack overflow hook, 360

starvation, 62
starving
 starvation, 64
state diagram, 65
Suspended State, 65
suspending the scheduler, 240
swapped in, 47
swapped out, 47
switched in, 47
switched out, 47
Synchronization, 191
Synchronization events, 64

T

tabs, 23
Task Functions, 46
task handle, 51, 82
Task Notifications, 293
Task Parameter, 55
Task Synchronization, 285
taskYIELD(), 98
Temporal
 temporal events, 64
the xSemaphoreCreateMutex(), 245
tick count, 61
tick hook function, 259
tick interrupt, 60
Tick Interrupt, 60
ticks, 61
TickType_t, 21
Time Measurement, 60
time slice, 60
Time Slicing, 92
Trace Hook Macros, 348
Trace macros, 348
traceBLOCKING_ON_QUEUE_RECEIVE, 349
traceBLOCKING_ON_QUEUE_SEND, 349
traceQUEUE_RECEIVE, 350
traceQUEUE_RECEIVE_FAILED, 351
traceQUEUE_RECEIVE_FROM_ISR, 352
traceQUEUE_RECEIVE_FROM_ISR_FAILED, 352
traceQUEUE_SEND, 349
traceQUEUE_SEND_FAILED, 350
traceQUEUE_SEND_FROM_ISR, 351
traceQUEUE_SEND_FROM_ISR_FAILED, 351
traceTASK_DELAY, 352
traceTASK_DELAY_UNTIL, 352
traceTASK_INCREMENT_TICK, 348
traceTASK_SWITCHED_IN, 349
traceTASK_SWITCHED_OUT, 348
Type Casting, 24

U

ulBitsToClearOnEntry, 310
ulBitsToClearOnExit, 311
ulTaskNotifyTake(), 300
uxQueueMessagesWaiting(), 113
uxTaskGetStackHighWaterMark(), 359
uxTaskPriorityGet(), 79

V

vApplicationStackOverflowHook, 360

Variable Names, 22
vPortDefineHeapRegions(), 36
vPortFree(), 27
vSemaphoreCreateBinary(), 194, 210
vTaskDelay(), 66
vTaskDelayUntil(), 70
vTaskDelete(), 85
vTaskGetRunTimeStats(), 344
vTaskNotifyGiveFromISR(), 299
vTaskPrioritySet(), 79
vTaskResume(), 65
vTaskSuspend(), 65
vTaskSuspendAll(), 241

X

xClearCountOnExit, 301
xEventGroupCreate(), 271
xEventGroupSetBits(), 271
xEventGroupSetBitsFromISR(), 272
xEventGroupSync(), 287
xEventGroupWaitBits(), 275

xPortGetFreeHeapSize(), 41
xPortGetMinimumEverFreeHeapSize(), 41
xQueueCreate(), 108, 132, 271
xQueuePeek(), 145
xQueueReceive(), 111
xQueueSend(), 109
xQueueSendFromISR(), 220
xQueueSendToBack(), 109, 144
xQueueSendToFront(), 109, 144
xSemaphoreCreateCounting(), 210
xSemaphoreCreateRecursiveMutex(), 253
xSemaphoreGiveFromISR(), 196
xSemaphoreGiveRecursive(), 253
xSemaphoreTakeRecursive(), 253
xTaskCreate(), 48
xTaskGetTickCount(), 72
xTaskNotify(), 307
xTaskNotifyFromISR(), 308
xTaskNotifyGive(), 298
xTaskNotifyWait(), 310
xTaskResumeAll(), 241
xTaskResumeFromISR(), 65

